

RO Pat tapitat Econo 140/160/180x200- Instrucțiuni de montaj

Atenție: La o montare defectuoasă există pericol de accident.
Se recomandă ca montarea să fie făcută de personal calificat.

EN Econo Upholstered Bed 140/160/180x200 - Assembly instructions

Warning: Deficient assembly can cause safety risks.
Assembly by qualified personnel is recommended.

Aveți nevoie de:

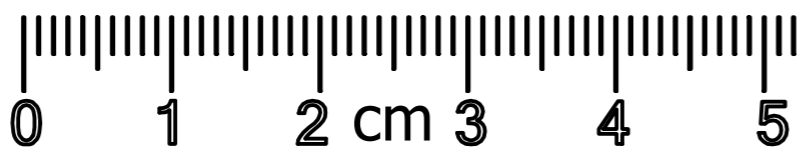

You'll need:

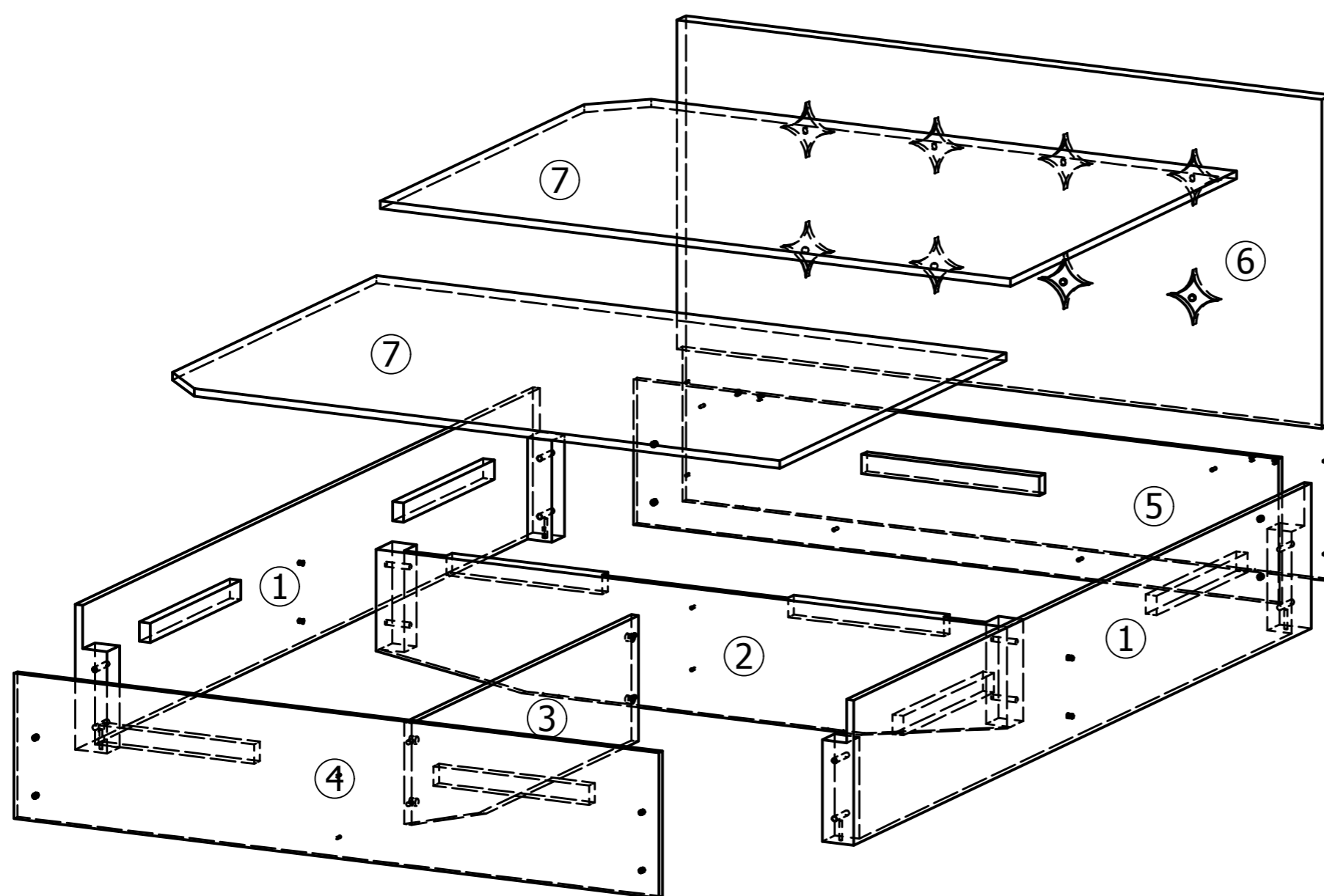
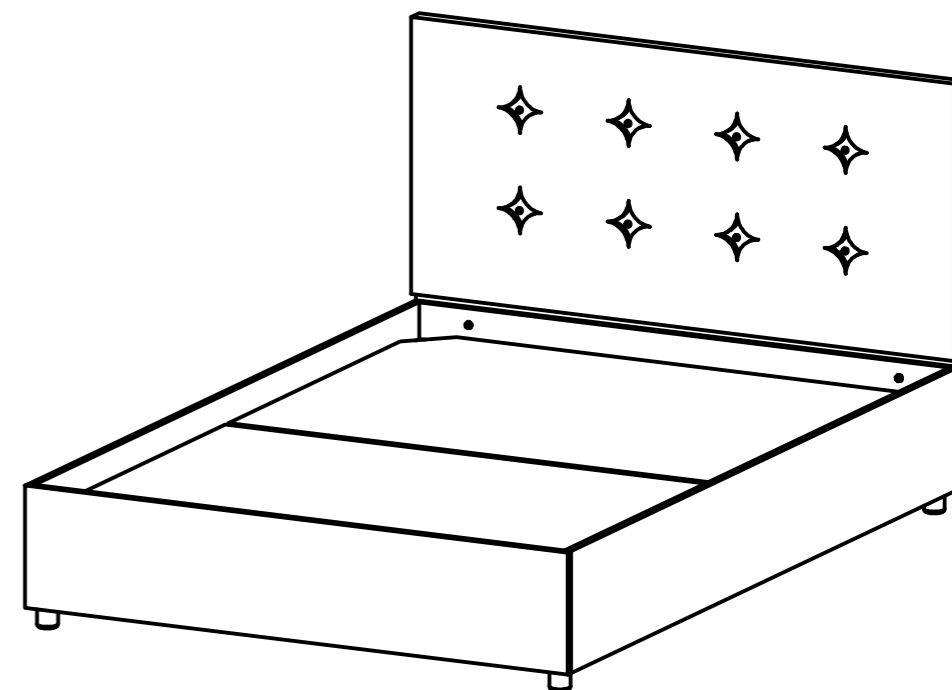
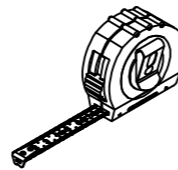
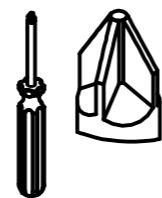
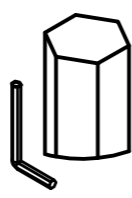
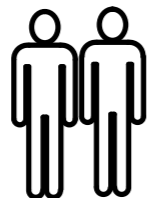
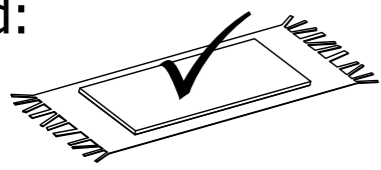

Piese / Parts

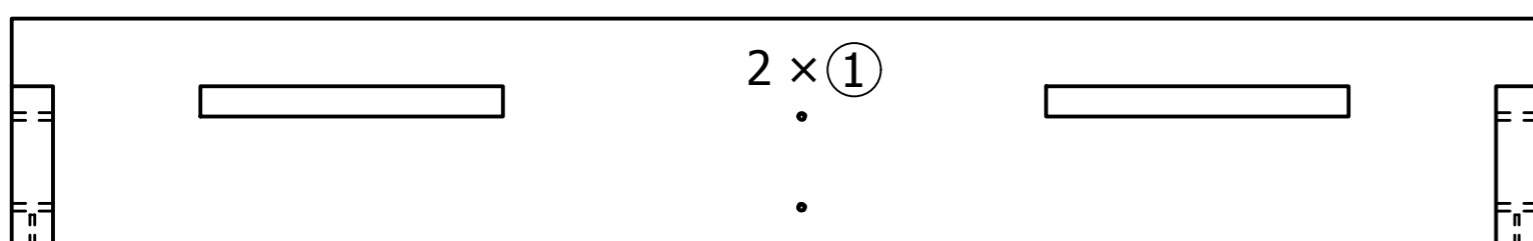

Laterala pat / Lateral bed

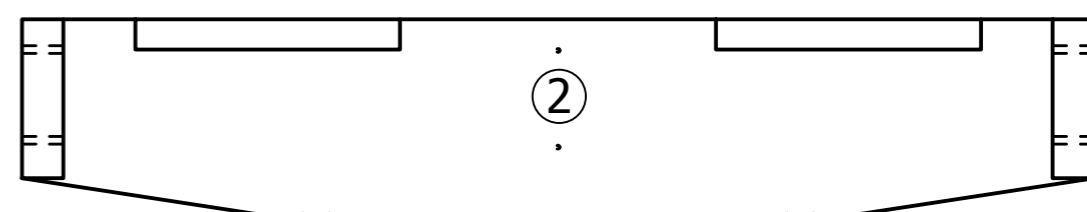

Legatura pat / Bed connection

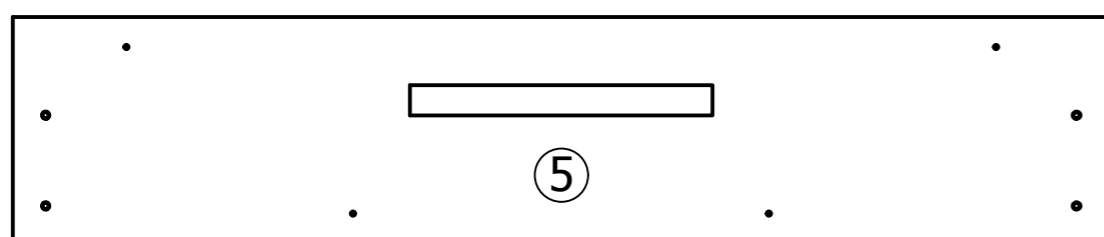
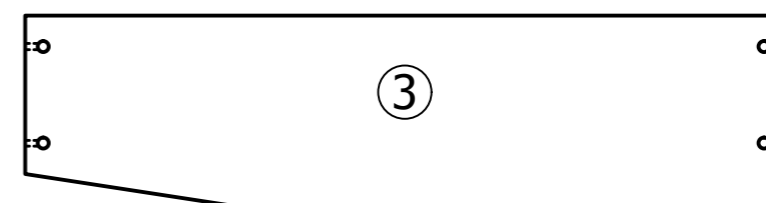

Table mica din spate / Back Small table



Legatura pat / Bed connection

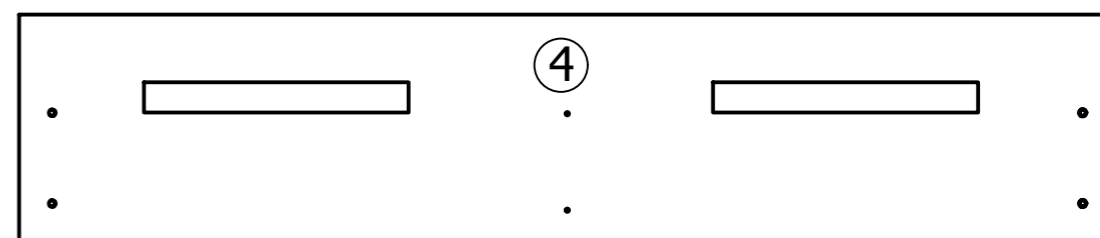
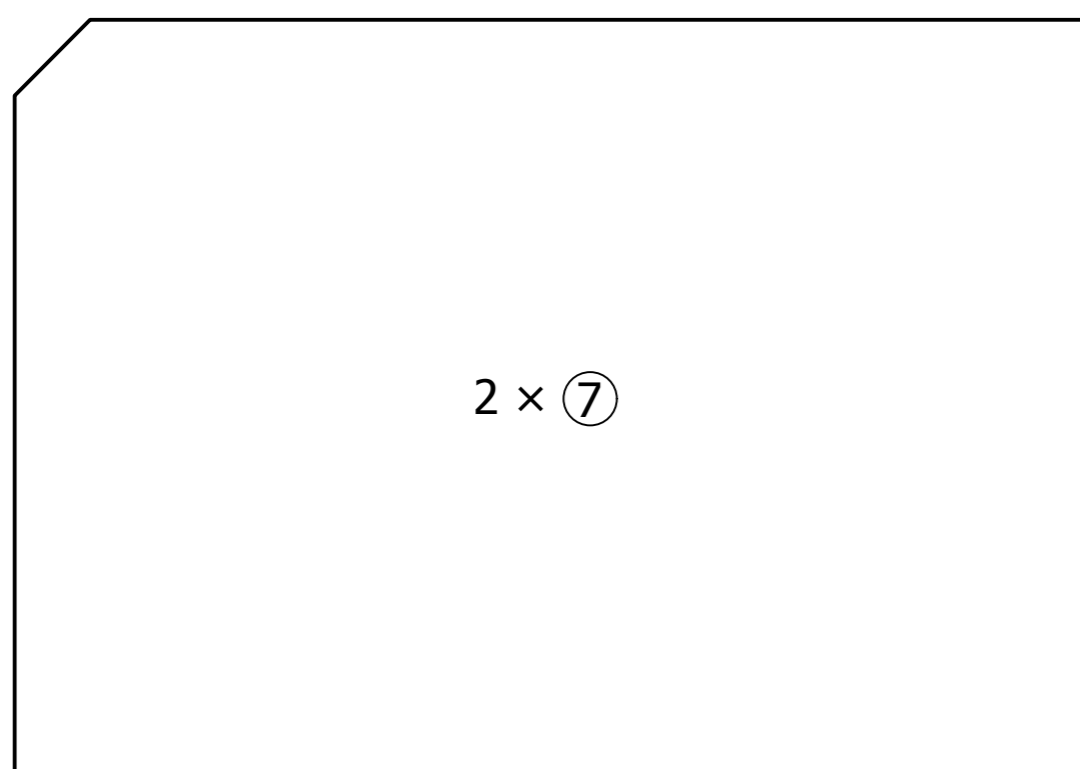

Table mica din fata / Font Small table



Panou suport saltea / Mattress support panel

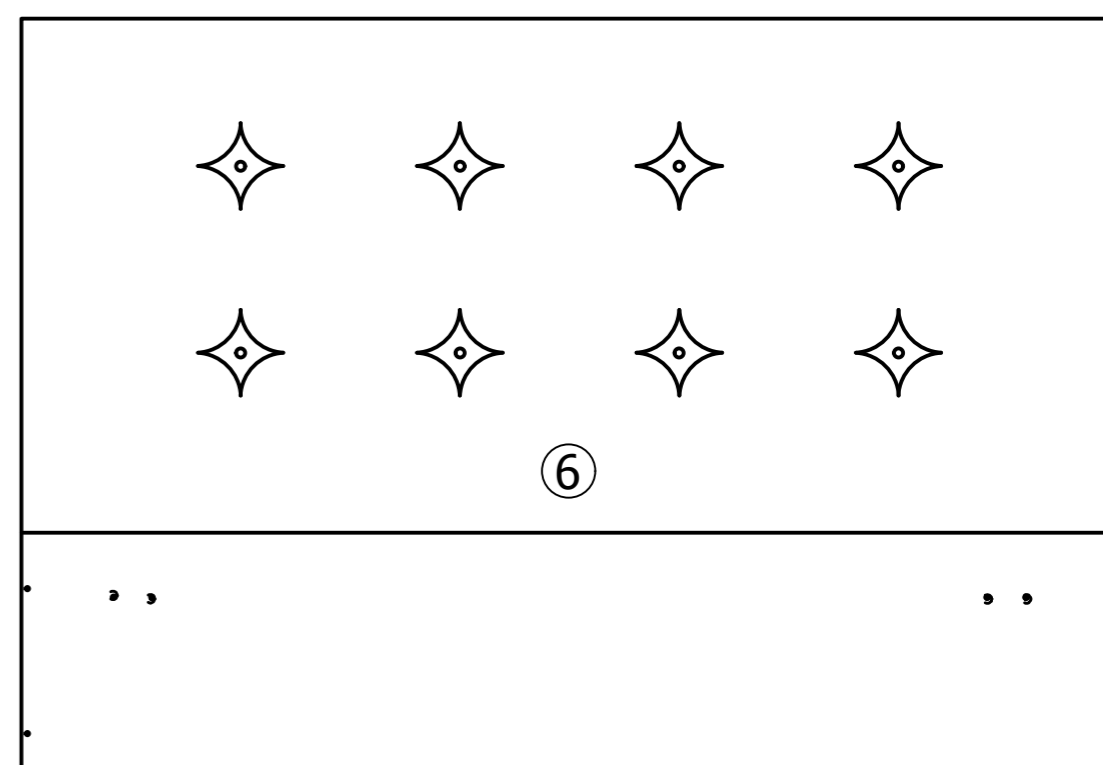
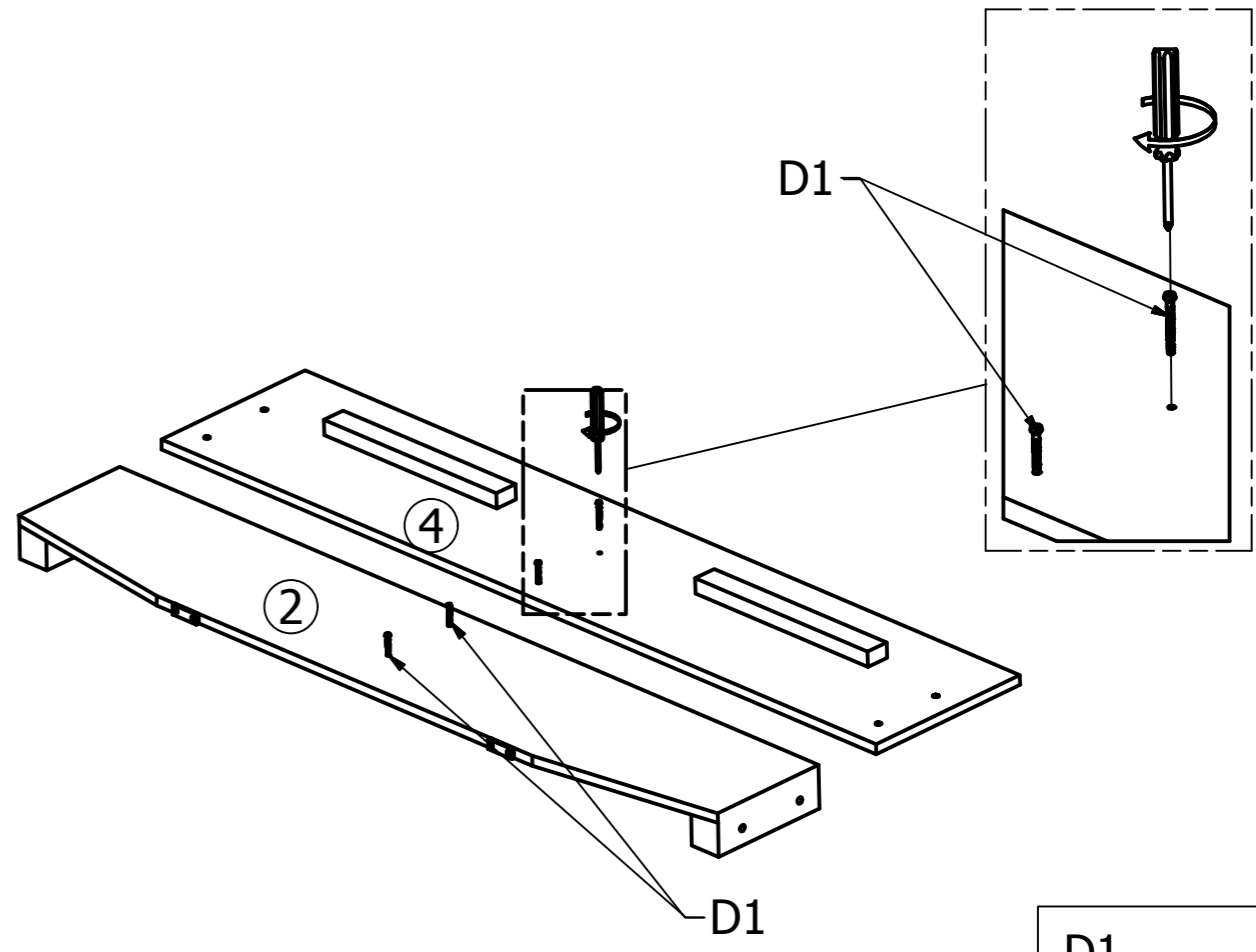
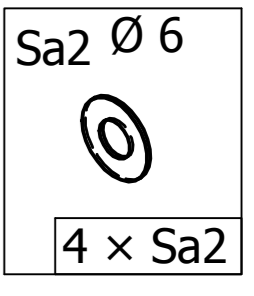
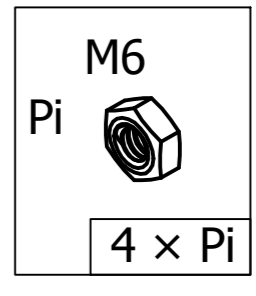
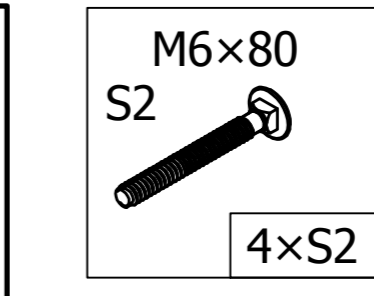
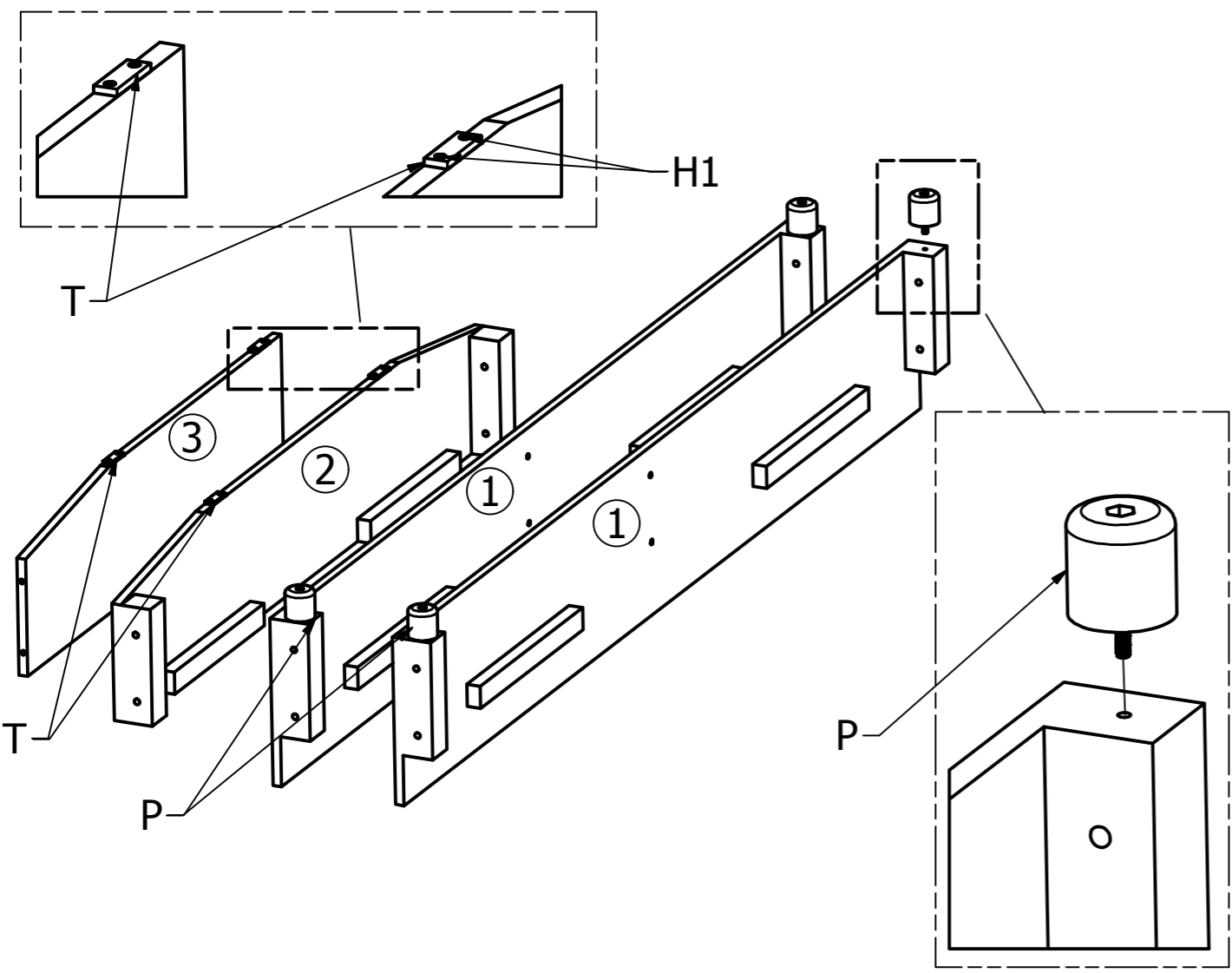
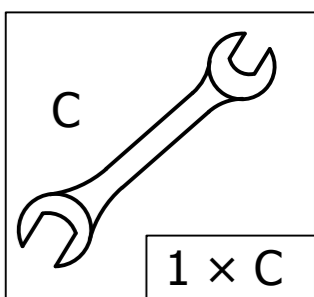
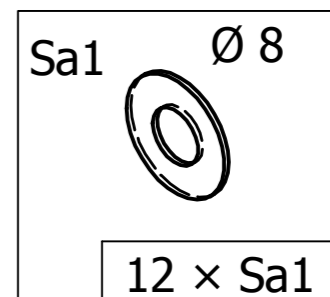
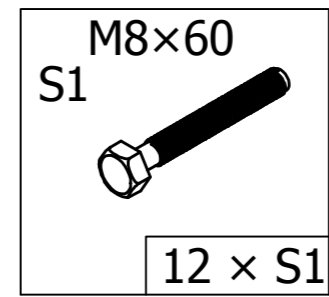
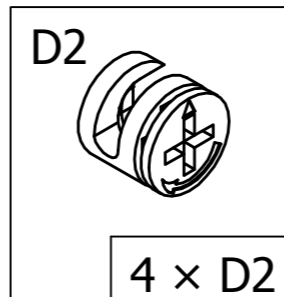
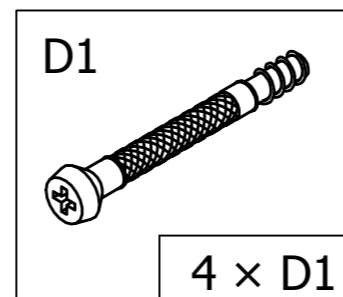
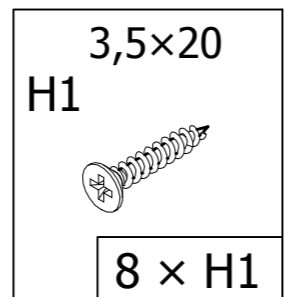
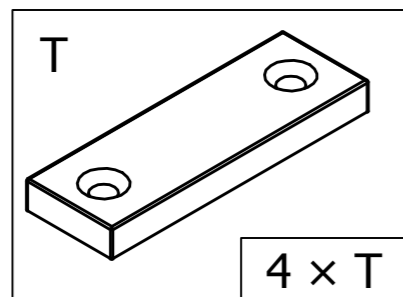
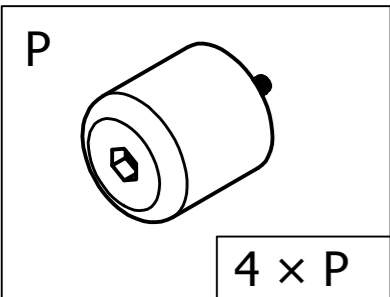
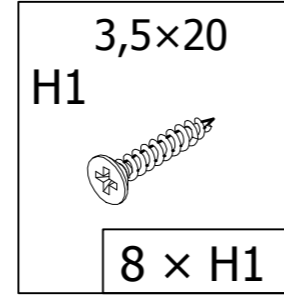
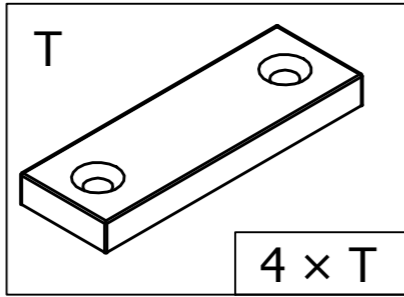
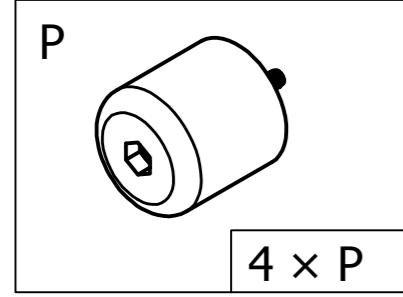

Table mare / Big table



1



2

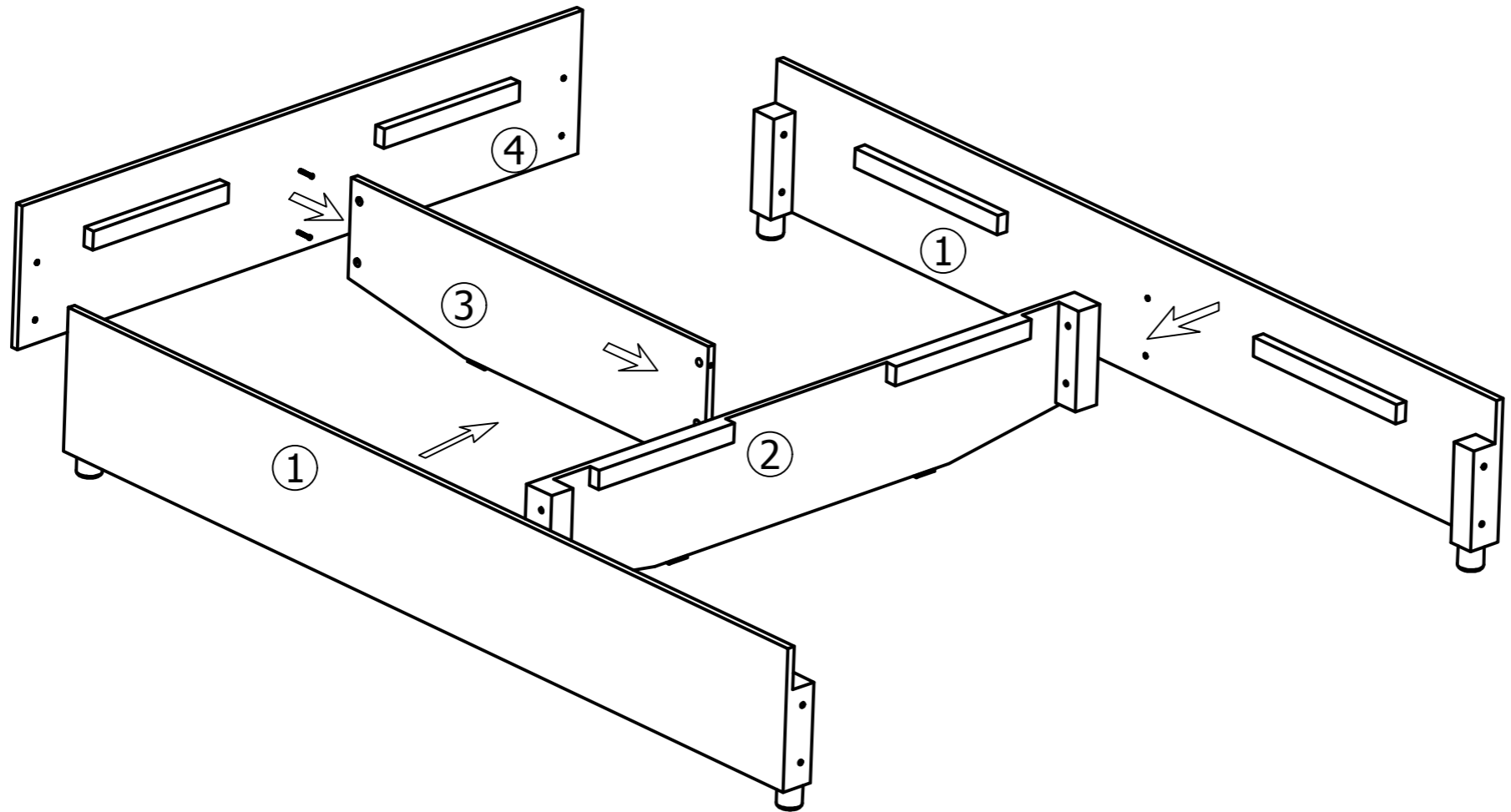
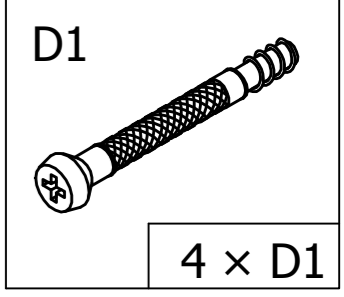

3A

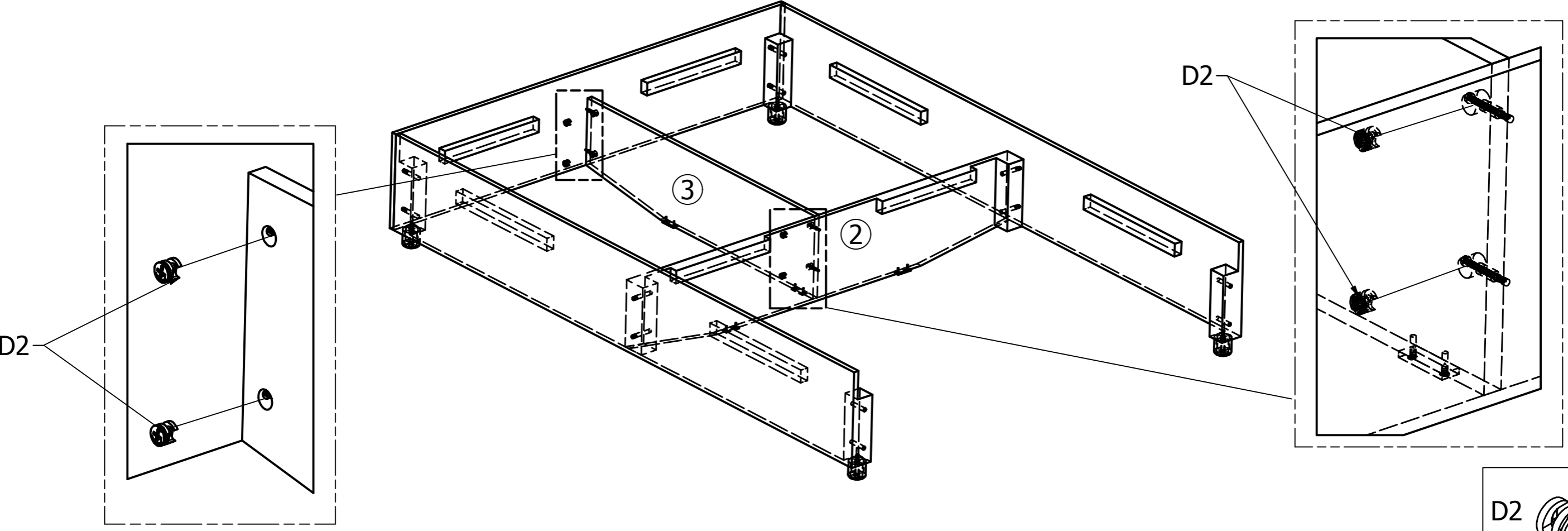

3B

