

Assembly instructions  
Instrucțiuni de montaj

PRODUCT : BEDROOM RAUL – SLIDING WARDROBE  
PRODUS: DORMITOR RAUL – DULAP CULISARE

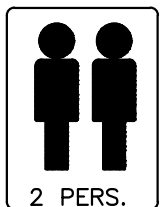
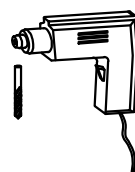
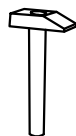
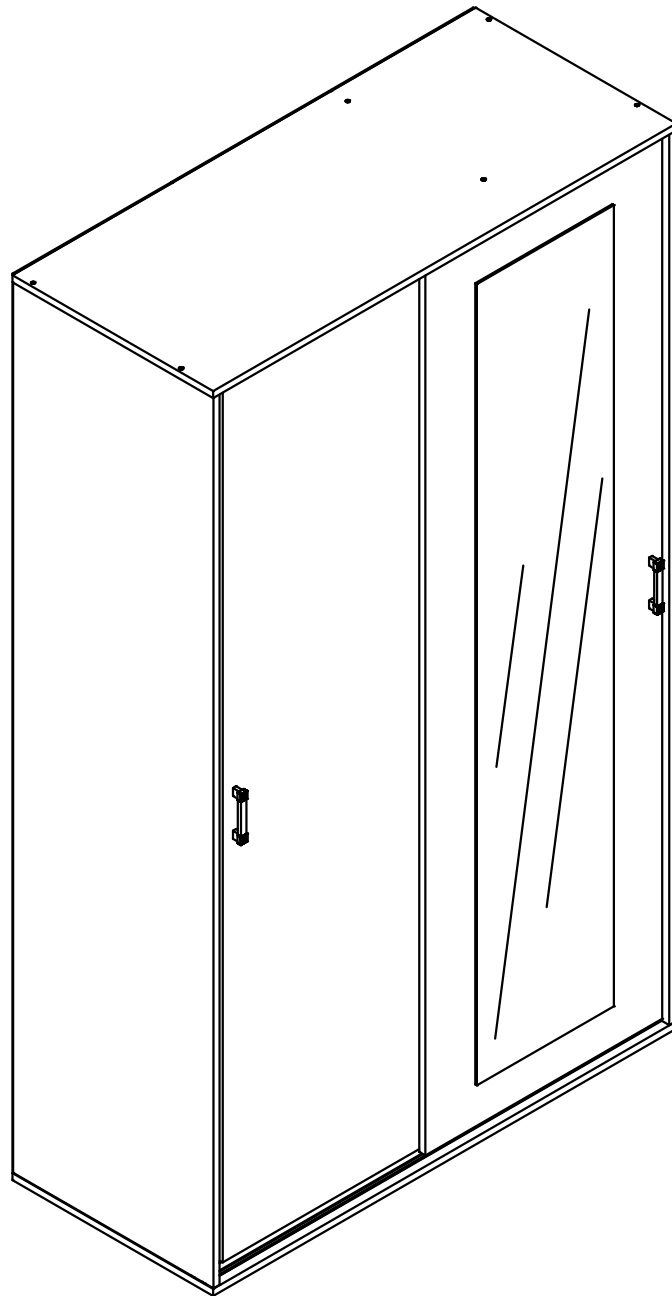

**ENG**

Dear customer,

- As a furniture producer we would like to inform you that a wall fixing furniture can be good only if the connection between fixing material (plugs) and the wall is better. For the suspended items check the wall and use only appropriate type of dowels (brick, BCA, plasterboard, etc.) purchased from a specialty store.
- Assembler is ultimately responsible for a fixed wall. Installation and laying of electrical items will be made only by qualified personnel and authorized.
- Follow the description and specification of Charge assembly instructions – in case overload that may occur due to children playing, because people, material or due to other factors – we assume no liability as a manufacturer of furniture.
- O perfect functionality of the furniture is assured only if the settlement this adjusts the horizontal and vertical. Only after that will adjust the doors.
- All screws and removable connection elements will be checked and tightened after 5 to 6 weeks to ensure safety of final fixation.
- Do not use abrasive cleansers
- If not follow the instructions on the use, maintenance or installation, if the products or changes, if changes or used parts that do not meet original pieces, then lose any warranty or claim responsibility of the manufacturer of furniture.

Incarcari maxime pentru polite in Kg: Maximum weight in Kg Shelf							
Grosime PAL melaminat Thick chipboard						Sticla Glass	
Lungime Length	mm	16	18	22	25	28	5 / 6/ 8
0 ≤ 400		8 kg	8 kg	8 kg	10 kg	10 kg	Lungime Length >600=5Kg.
401 ≤ 600		6 kg	6 kg	6 kg	6 kg	6 kg	
601 ≤ 800		5 kg	5 kg	5 kg	5 kg	5 kg	Lungime Length >1000=2Kg.
801 ≤ 1000		3 kg	3 kg	3 kg	3 kg	3 kg	







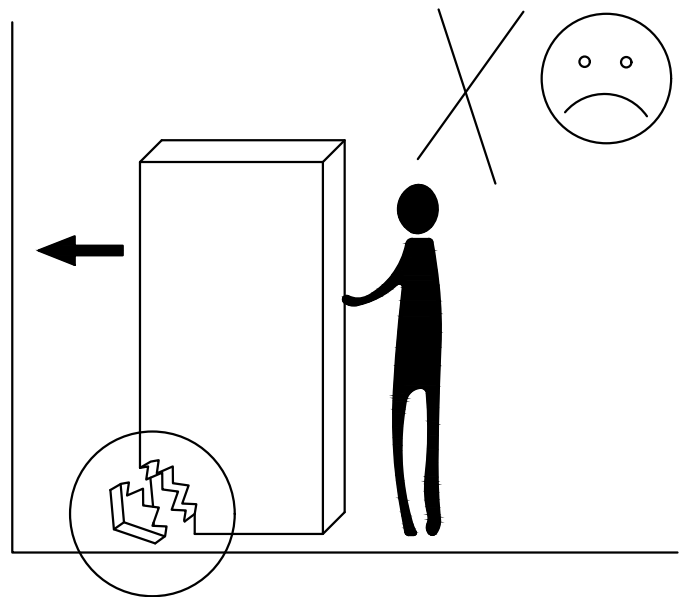
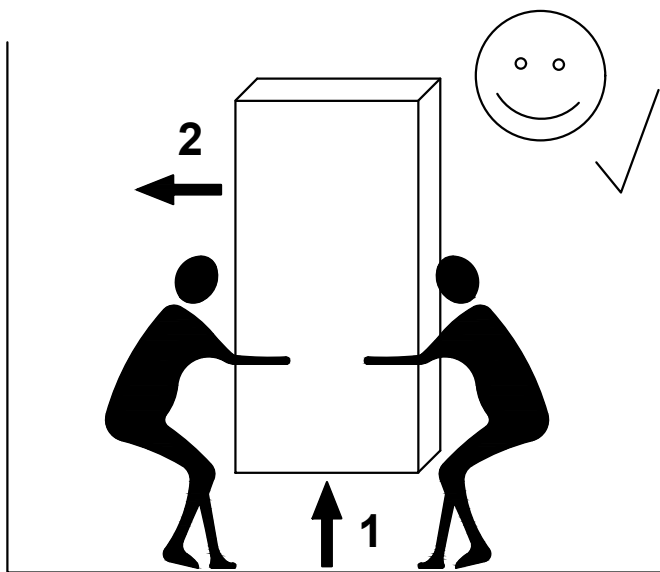
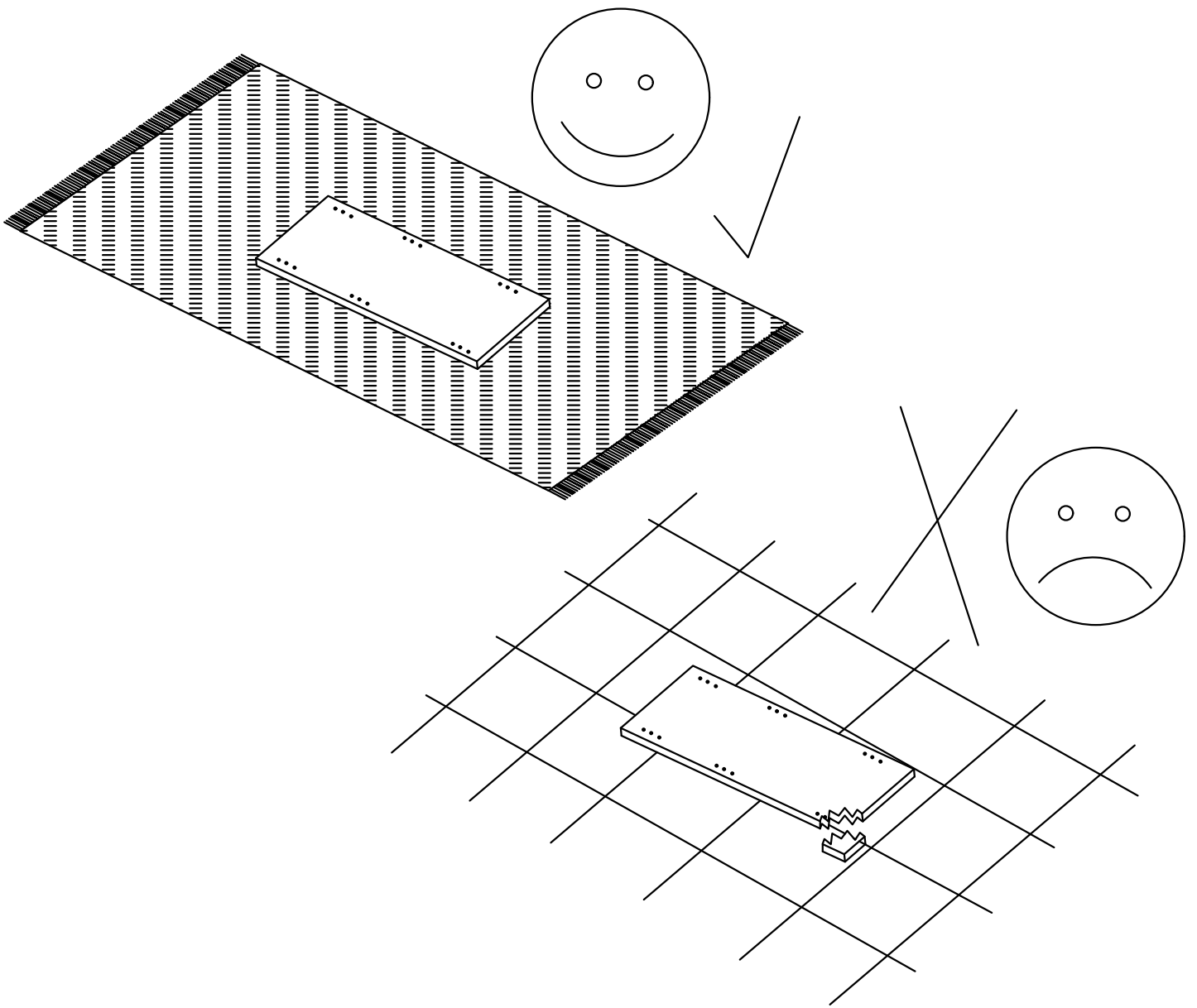

**RO**

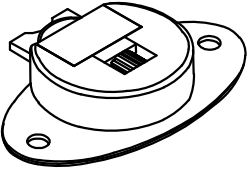
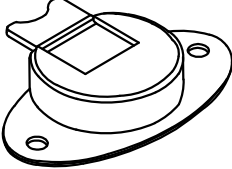
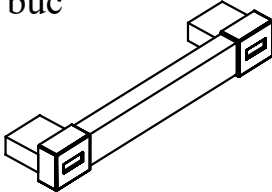
Stimate client,

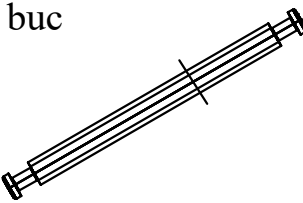
În calitate de producător de mobilier am dori să vă informăm că o fixare a mobilierului de perete poate fi bună doar dacă legătura dintre materialul de fixare (dibluri) și perete este bună. În cazul corpurilor suspendate verificați peretele și folosiți doar dibluri corespunzătoare tipului de perete (caramida, BCA, rigips, etc.) achiziționate dintr-un magazin de specialitate. În definitiv montatorul este responsabil de fixarea de perete.

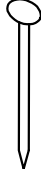
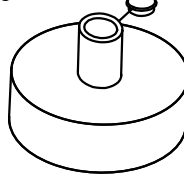
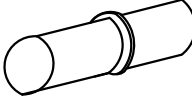
- Montarea și pozarea articolelor electrice se va efectua doar de către personal calificat și autorizat.
- Respectați descrierea și specificațiile de încărcare din instrucțiunile de montaj – în caz de supraîncărcare ce poate să apară datorită copiilor care se joacă, datorită persoanelor, materialului sau datorită altor factori – nu ne asumăm nici o răspundere ca producător de mobilier.
- O funcționalitate perfectă a mobilierului este asigurată doar în cazul în care la așezare, aceasta se reglează pe orizontală și verticală. Doar după aceasta se vor regla ușile.
- Toate șuruburile și elementele de îmbinare demontabile vor trebui verificate și strânse după 5 până la 6 săptămâni pentru a se asigura o siguranță definitivă a fixării.
- Nu folosiți agenți de curățare abrazivi
- În cazul în care nu se respectă instrucțiunile de utilizare, de deservire sau de montaj, dacă se efectuează modificări ale produselor, dacă se schimbă piese sau se folosesc piese care nu corespund pieselor originale, atunci se pierde orice garanție sau pretenție de responsabilitate din partea producătorului de mobilier.

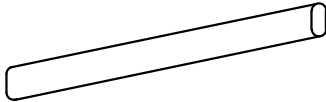
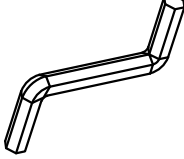
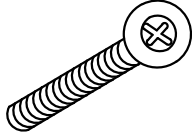
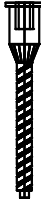

<p>PR-55R</p> <p>4 buc</p> 	<p>PR-55G</p> <p>4 buc</p> 	<p>M-07</p> <p>2 buc</p> 
<p>D-001</p> <p>8 buc</p> 	<p>D-002</p> <p>4 buc</p> 	<p>D-004</p> <p>2 buc</p> 
<p>S1-16</p> <p>20 buc</p> 	<p>T-01</p> <p>80 buc</p> 	<p>PI-20</p> <p>6 buc</p> 
<p>S-001</p> <p>12 buc</p> 	<p>S1S-16</p> <p>12 buc</p> 	<p>BH-0V</p> <p>1 buc</p> 
<p>HEX</p> <p>1 buc</p> 	<p>S3-22</p> <p>4 buc</p> 	<p>E-50</p> <p>12 buc</p> 
<p>H</p> <p>1 buc</p> 	<p>SBH</p> <p>2 buc</p> 	

## Caracteristici tehnice produs

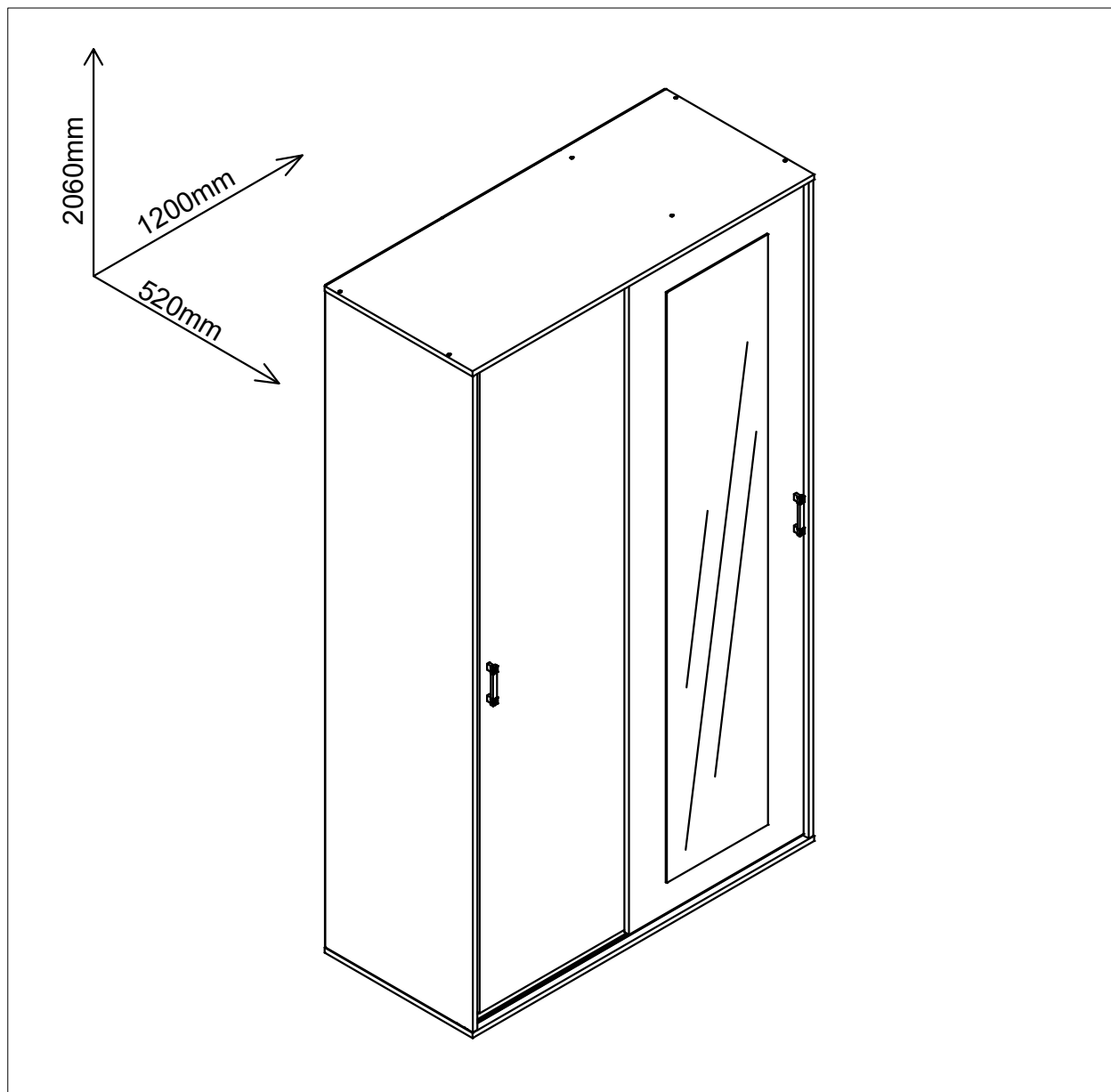

- Materiale:
- Placi din aschii de lemn (PAL), meleminate de grosime = 16 mm
  - Placi din fibre de lemn de inalta densitate (HDF) de grosime = 3 mm
  - Cant ABS 0.5 mm
  - Fronturi mate si fronturi textura
  - Elemente de imbinare metalice
  - Picioare reglabile din material plastic H = 27 mm
  - Bara haine din inox
  - Sistem de culisare din material plastic
  - Sine de culisare metalice
  - Oglinda

2000x519.5x16

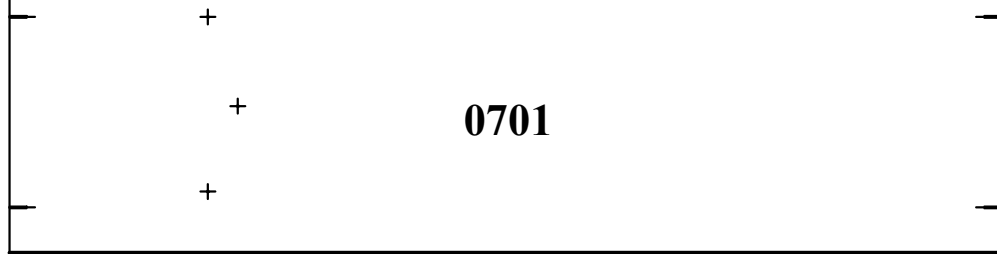

2000x519.5x16

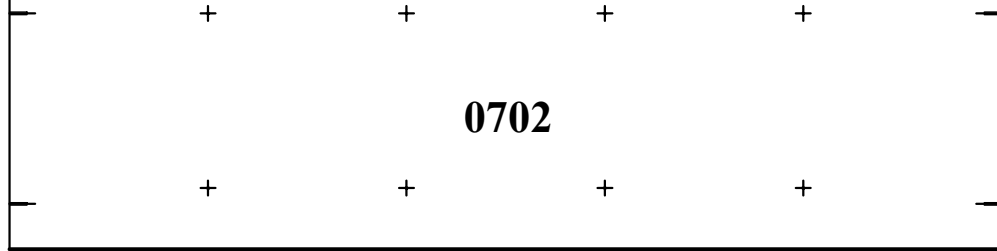

2000x440.5x16

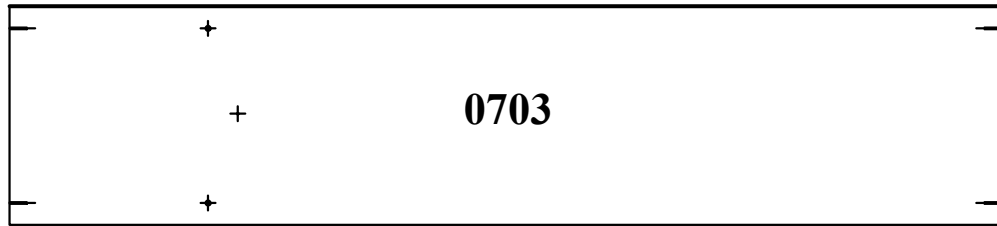
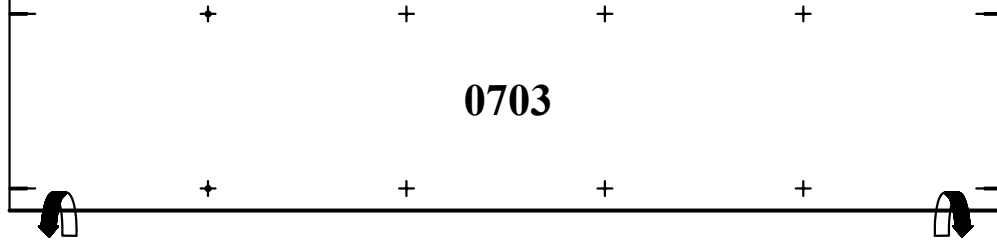

1991x614x16



1991x614x20

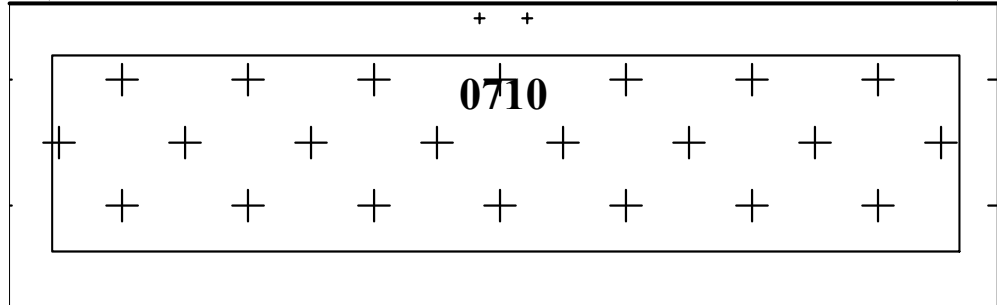
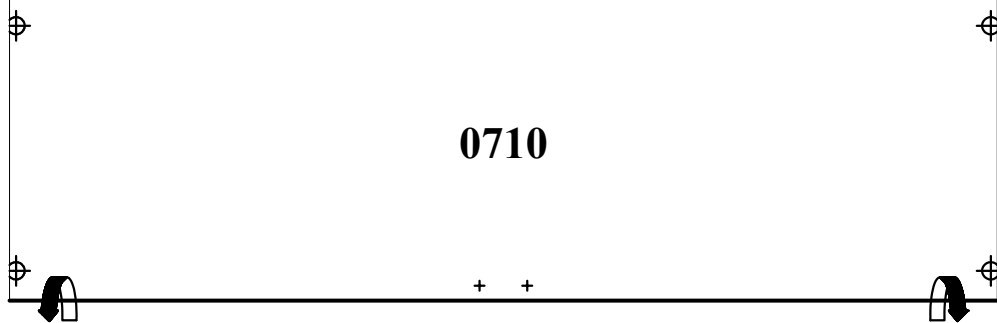

1201x520.5x16

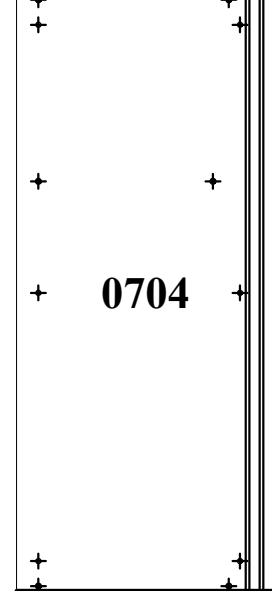

1201x520.5x16

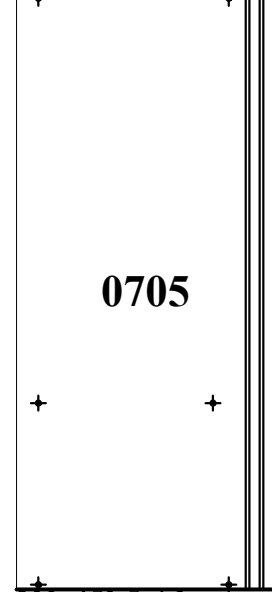

800x450.5x16

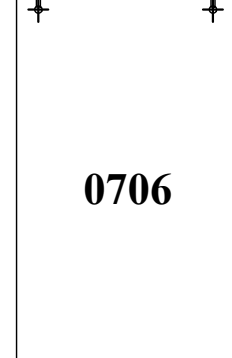

350x450.5x16

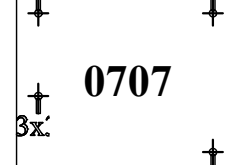

350x450.5x16

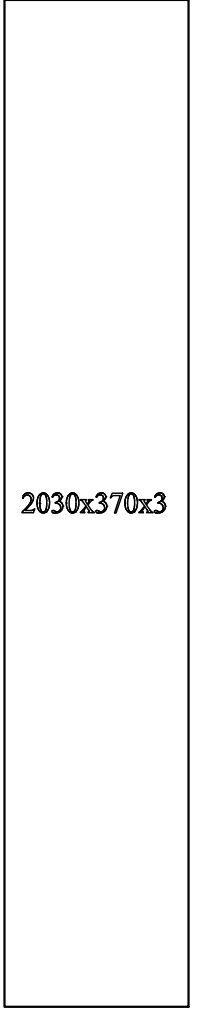
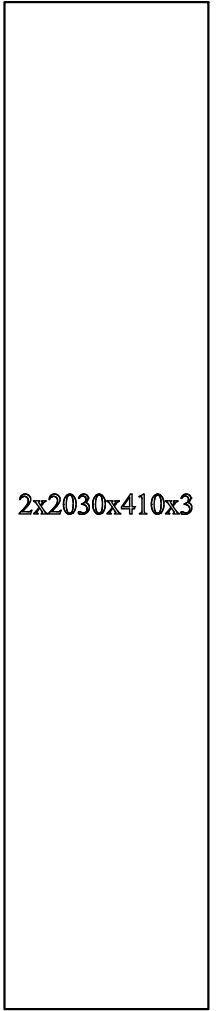

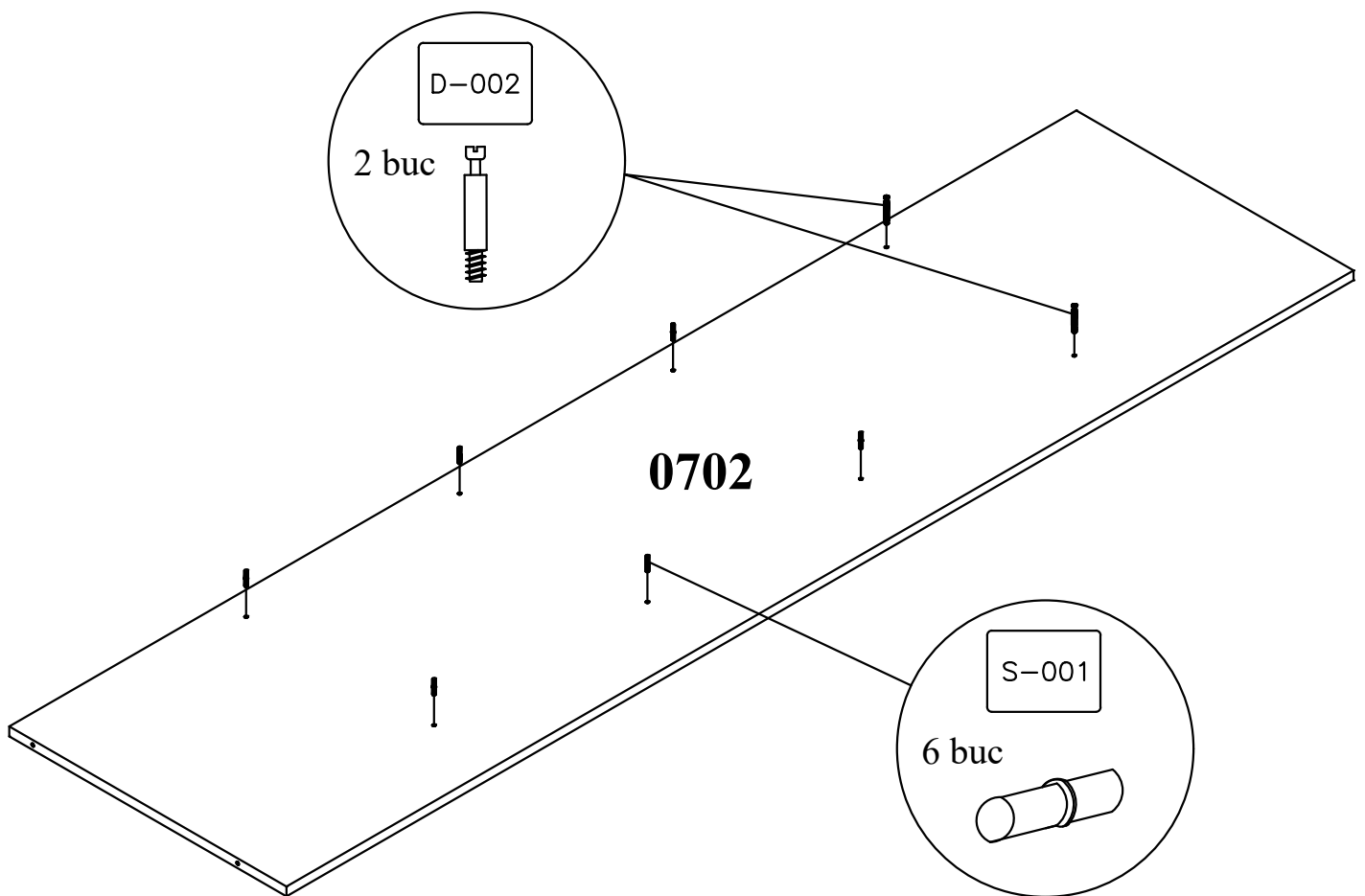
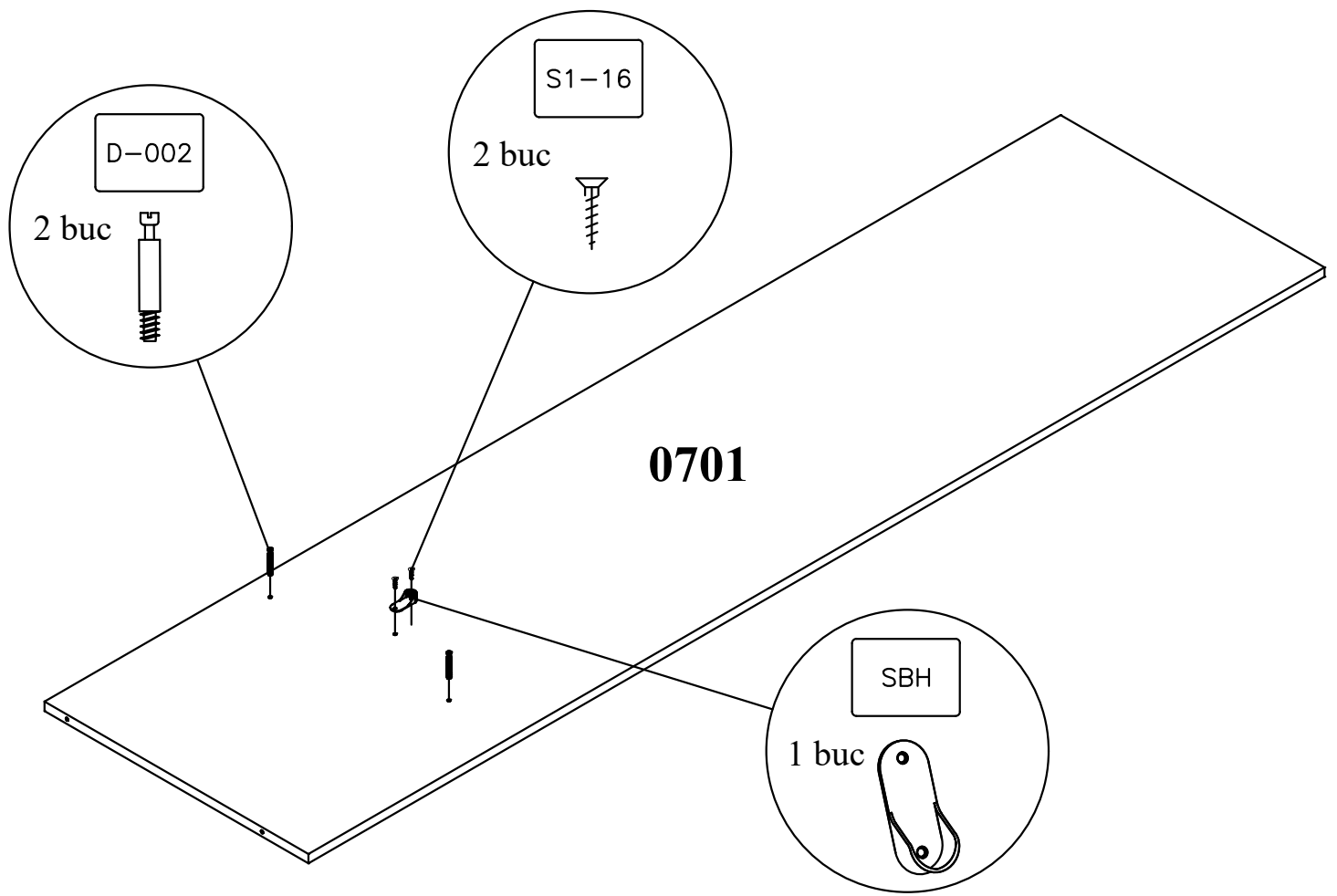

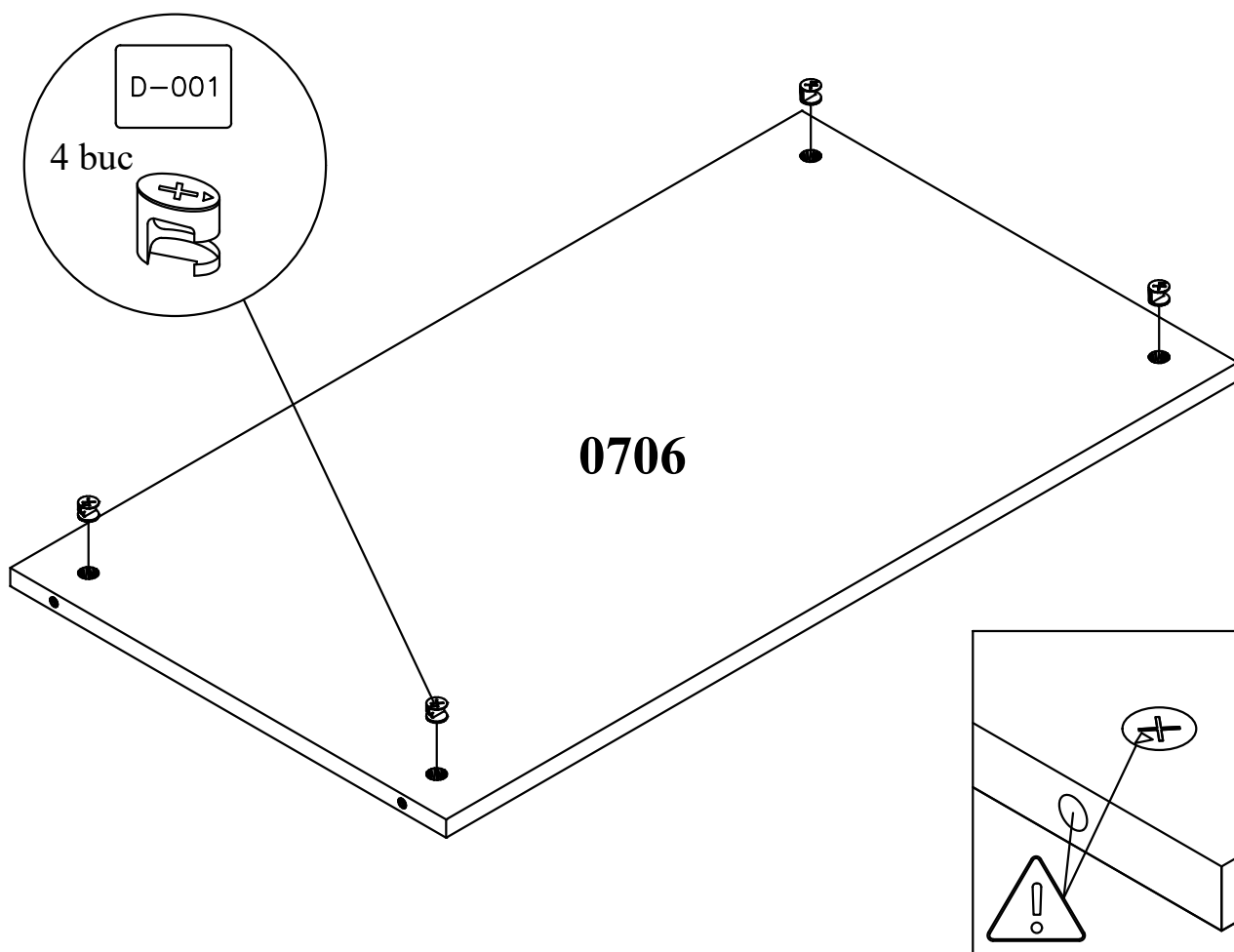
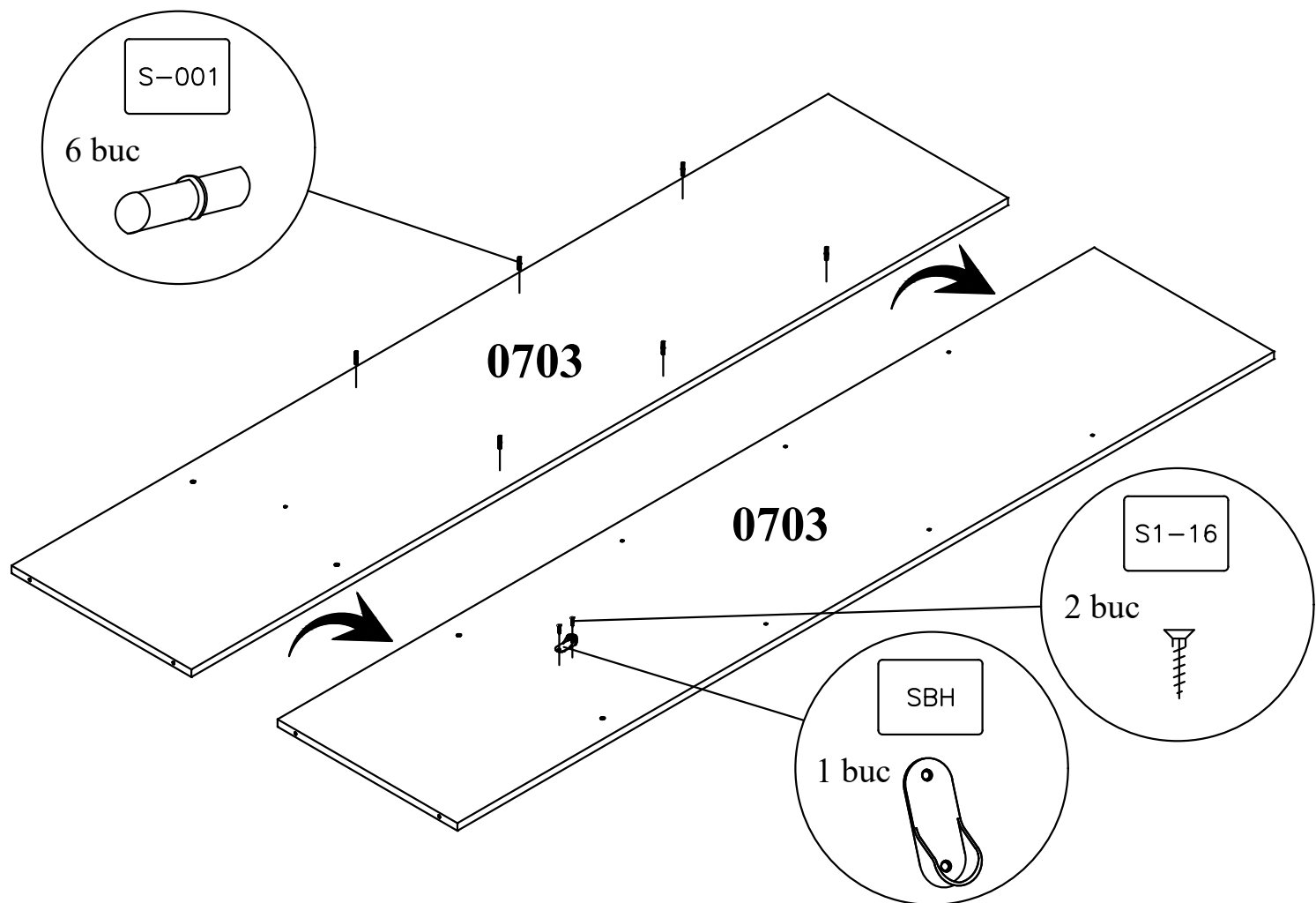



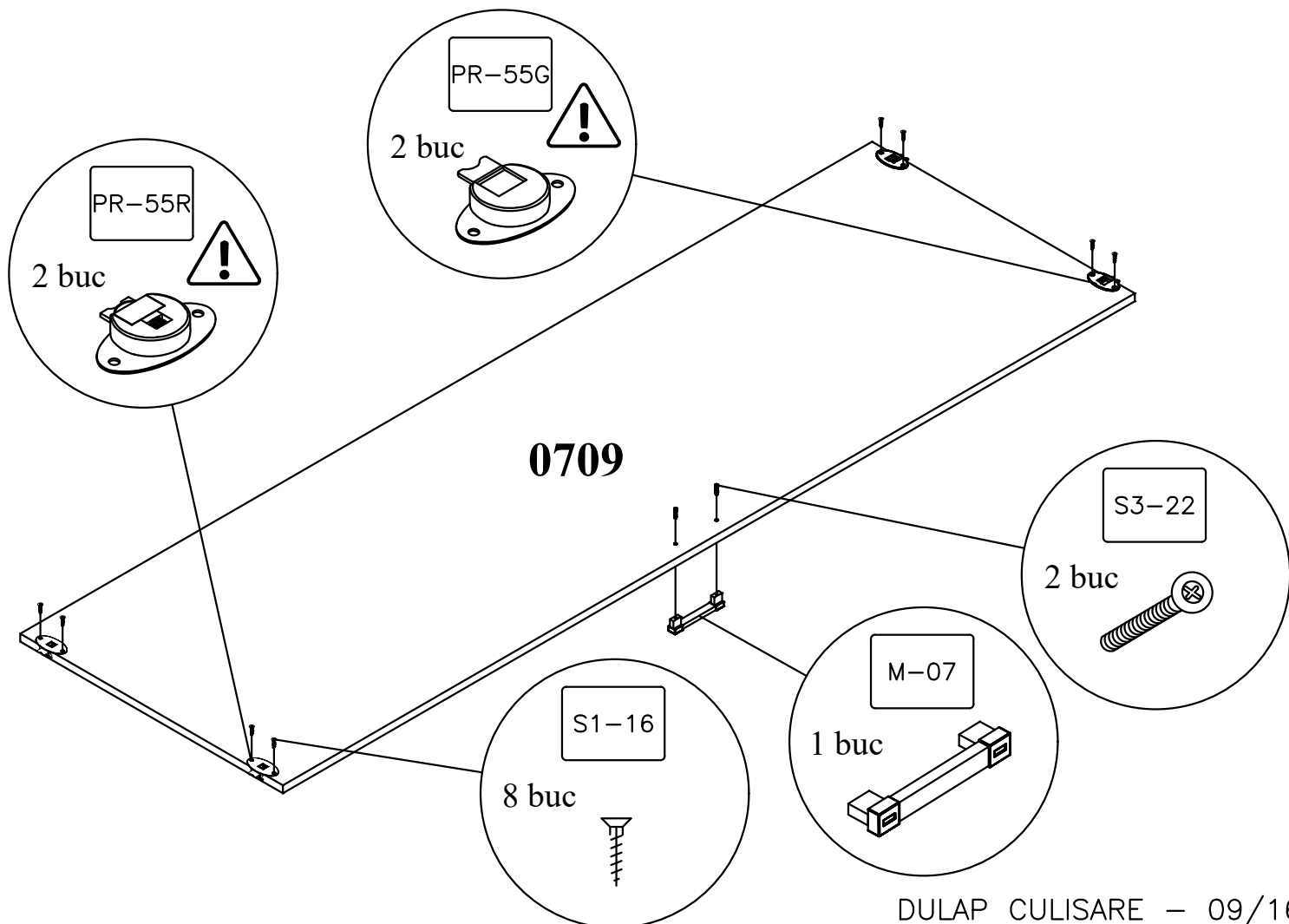
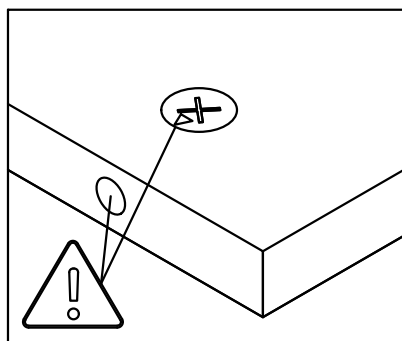
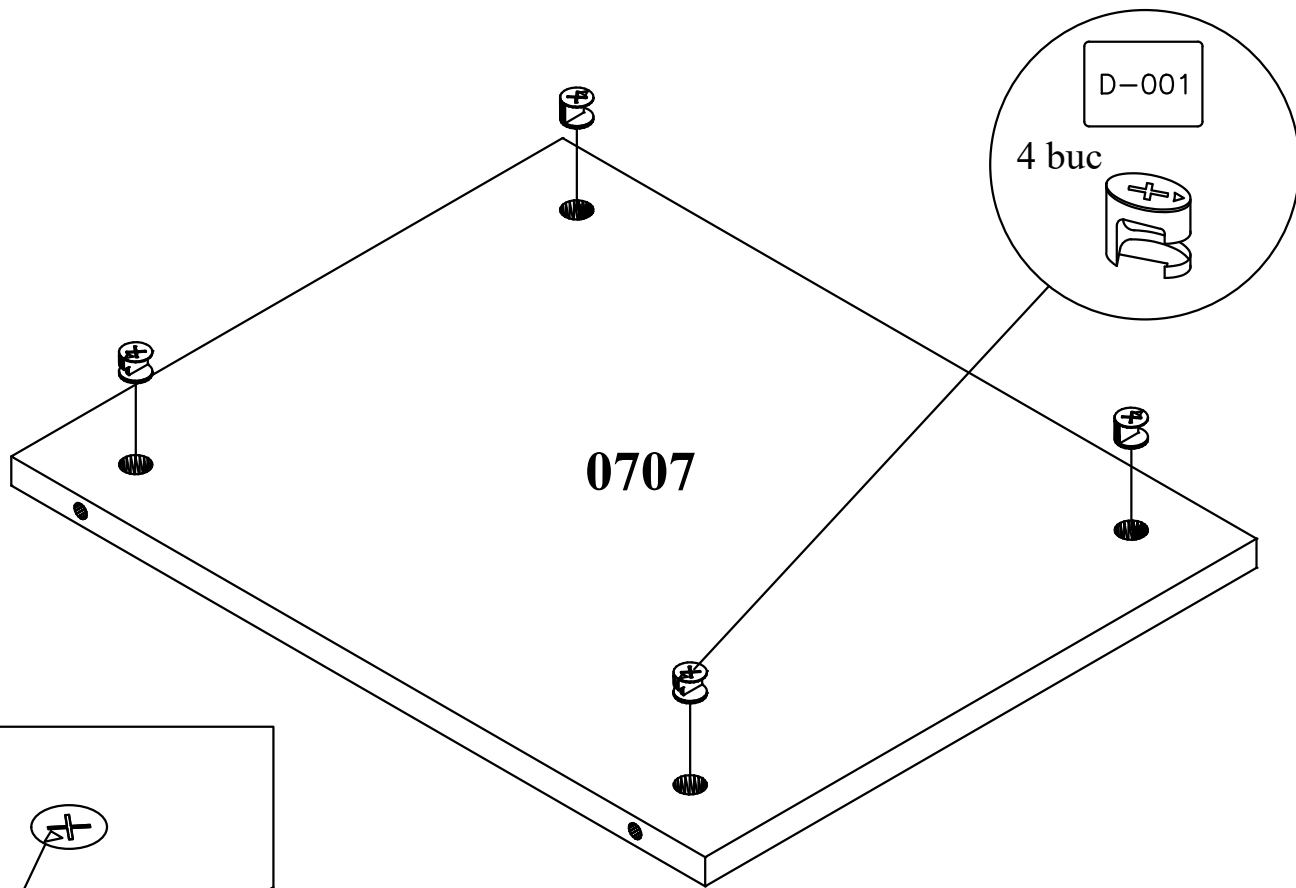

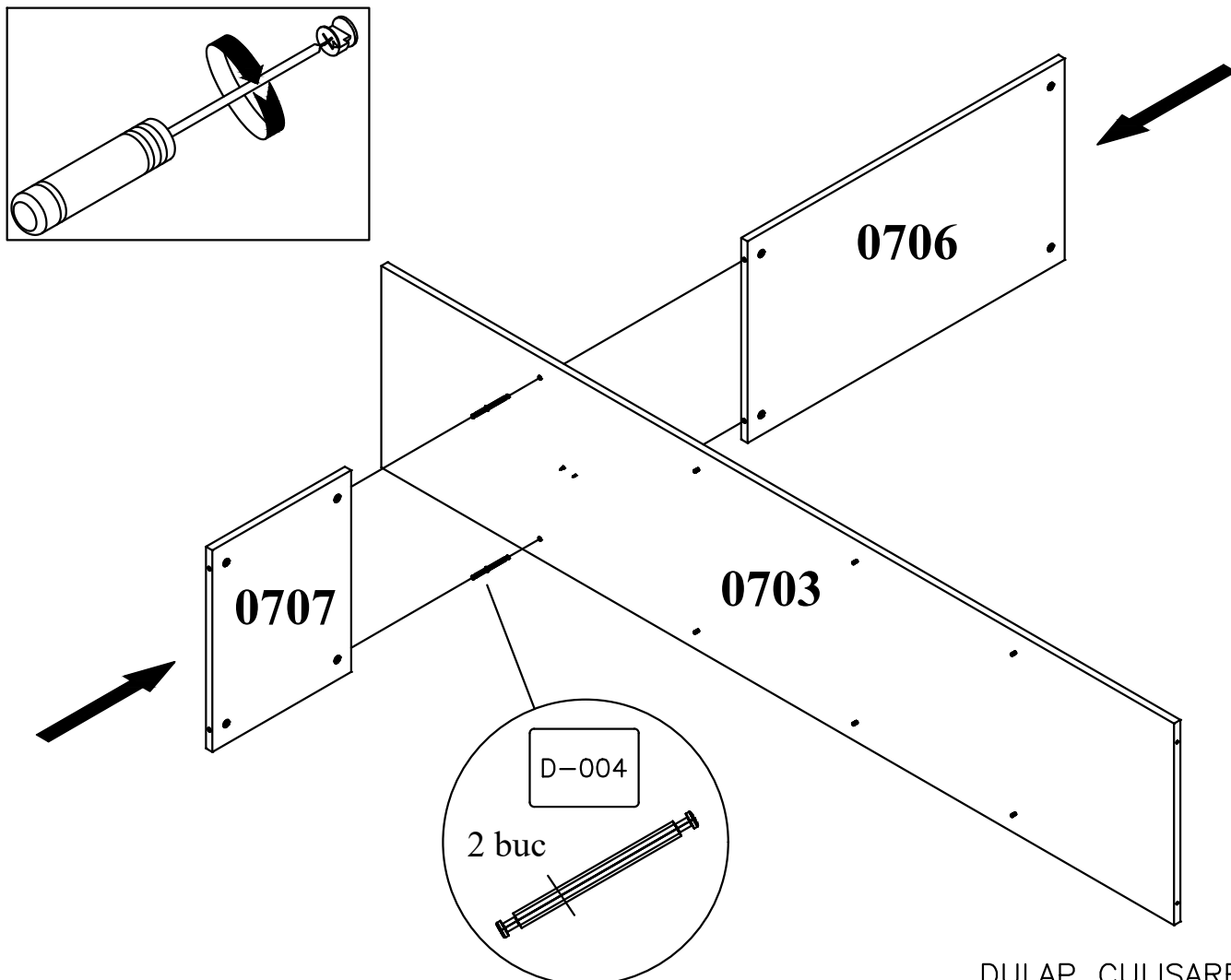
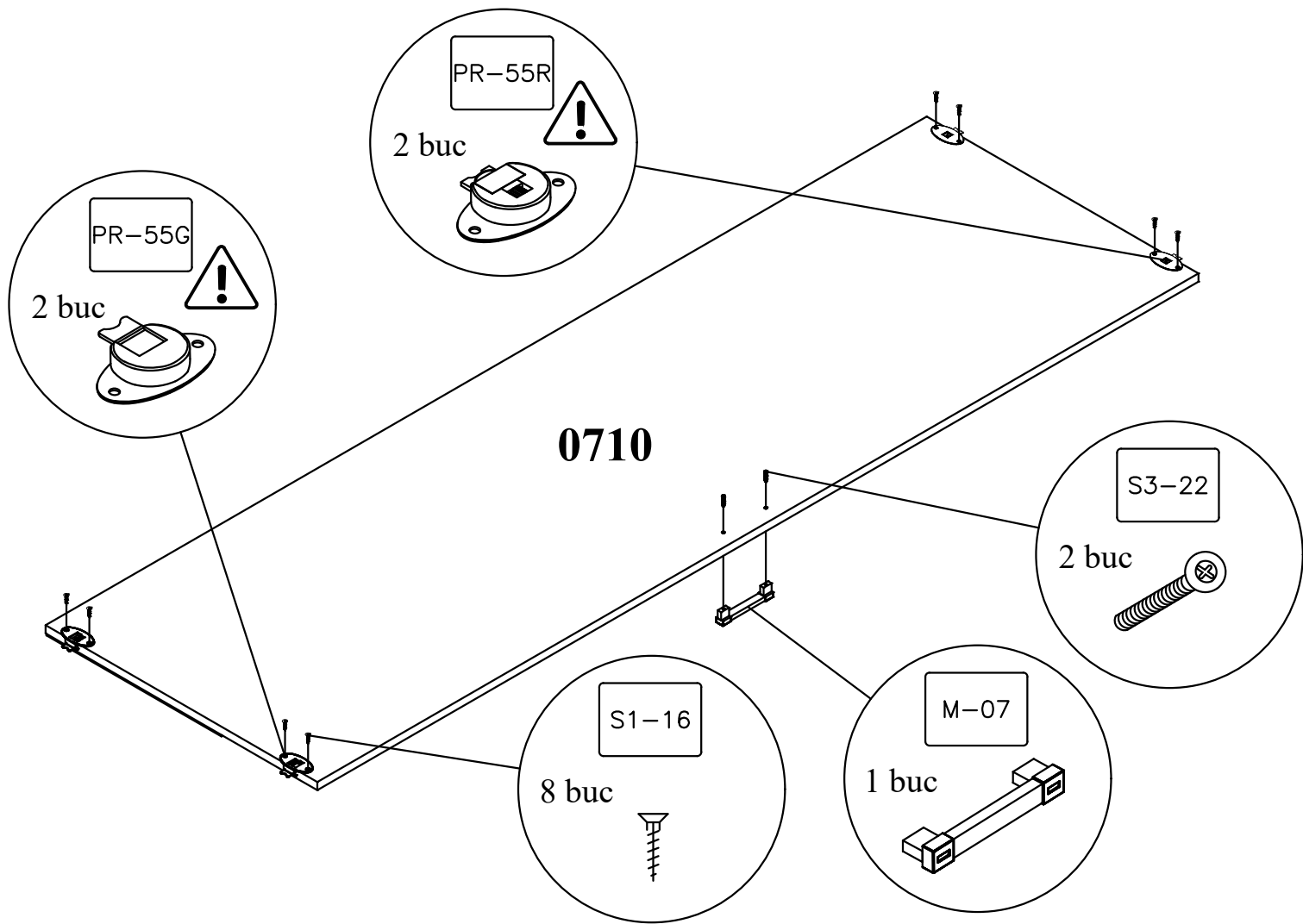

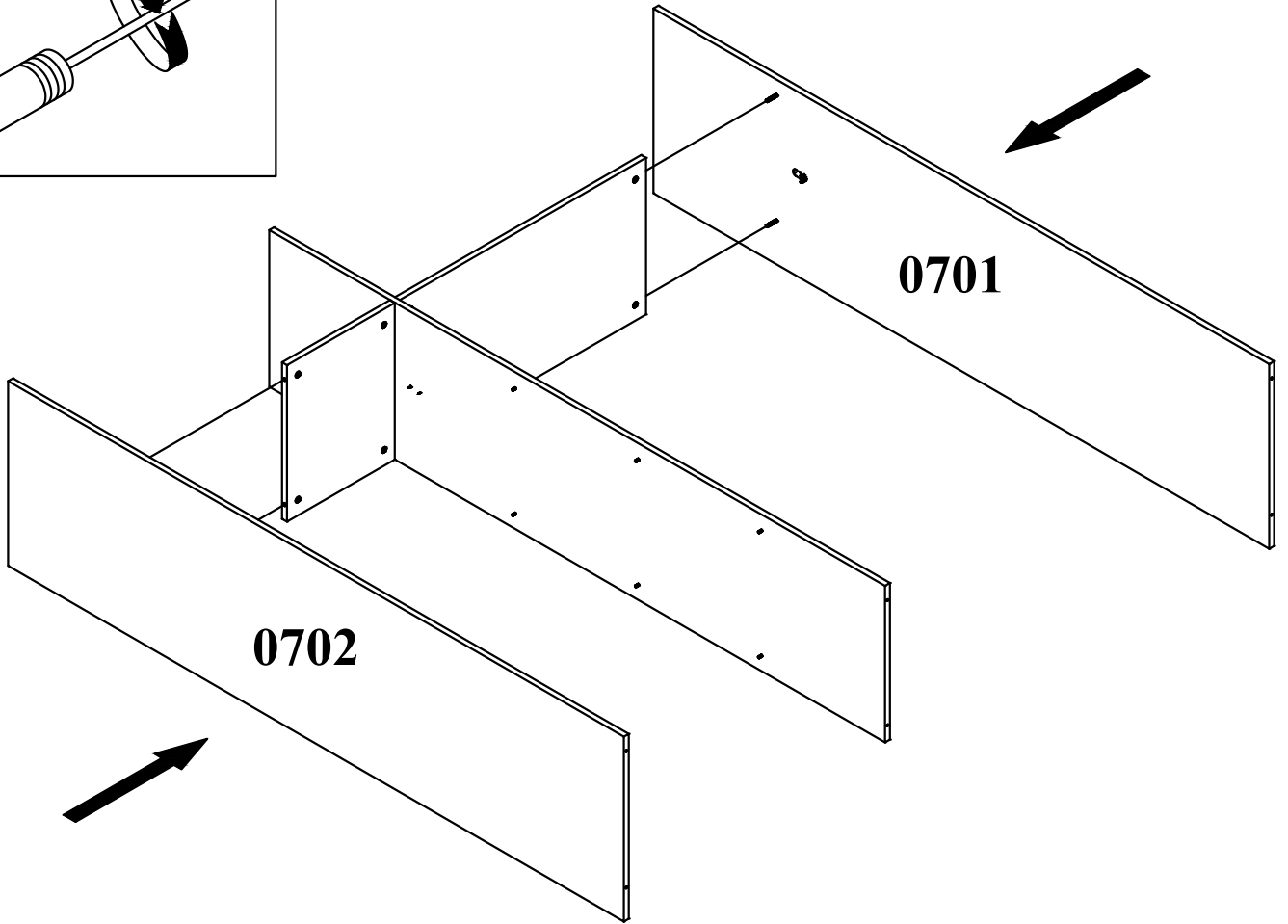
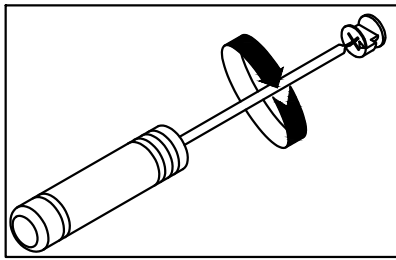

**0701**

**0702**

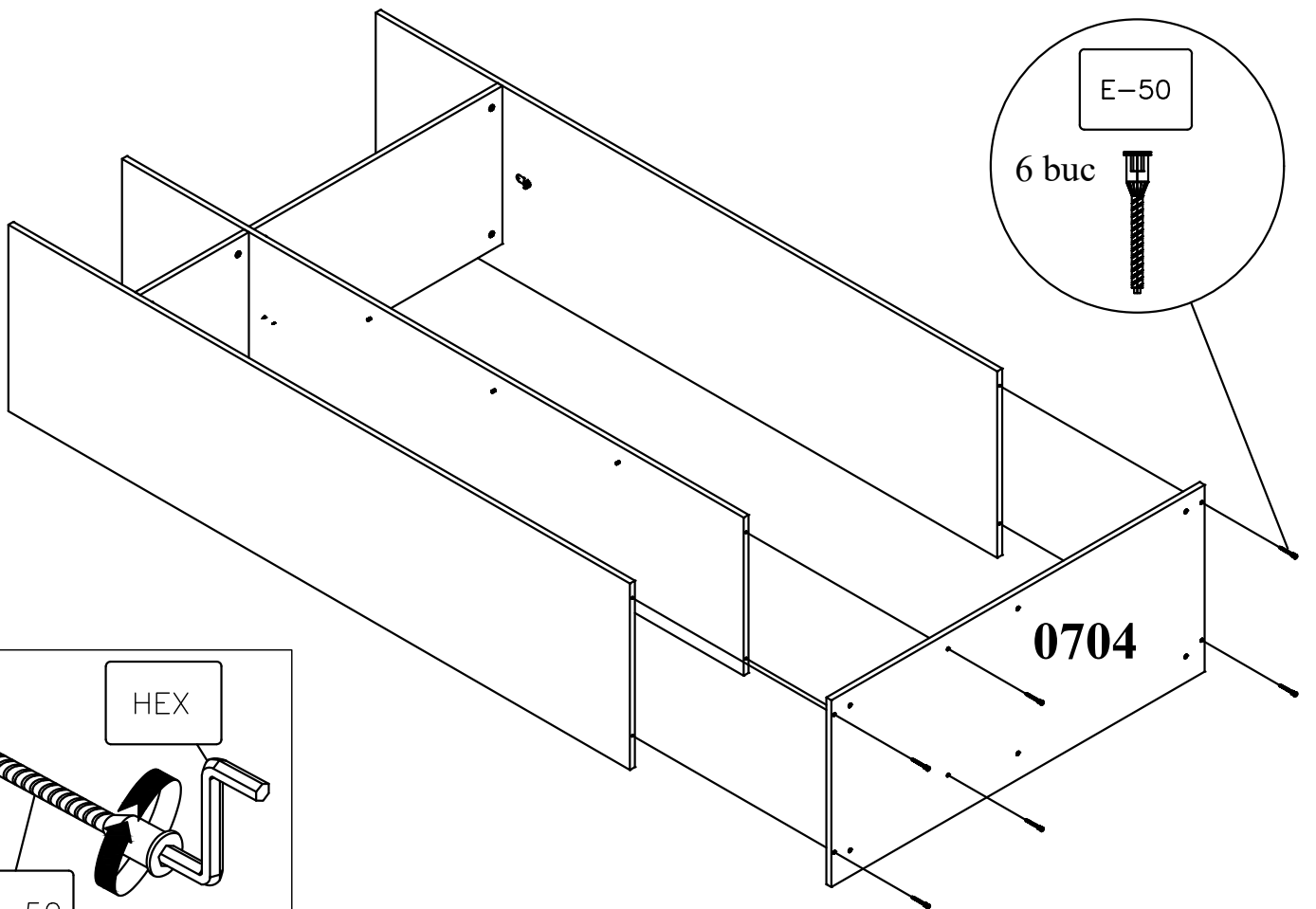

E-50

6 buc

**0704**

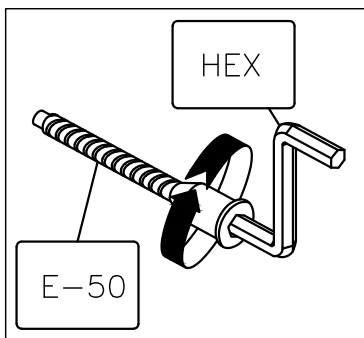

HEX

E-50

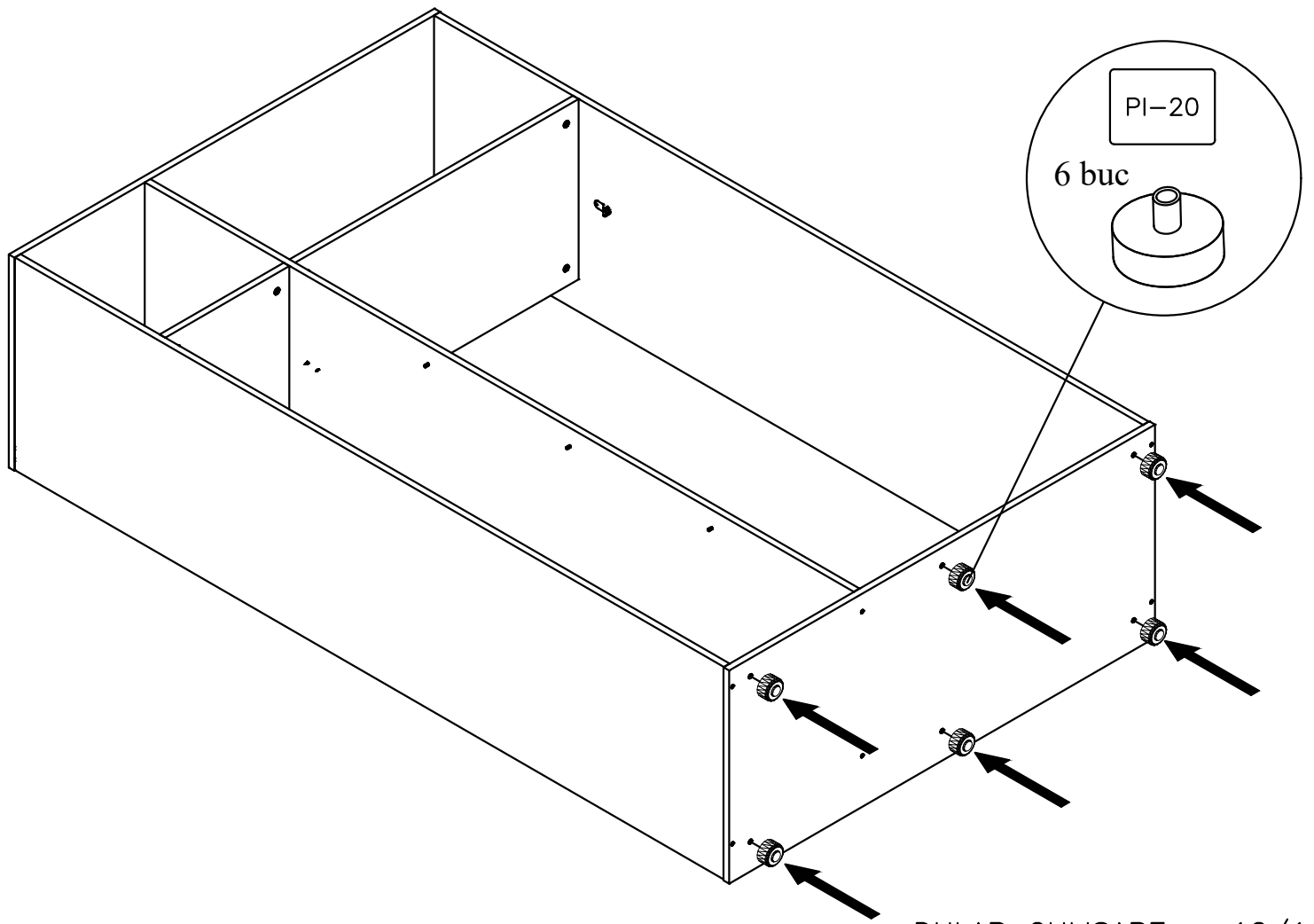
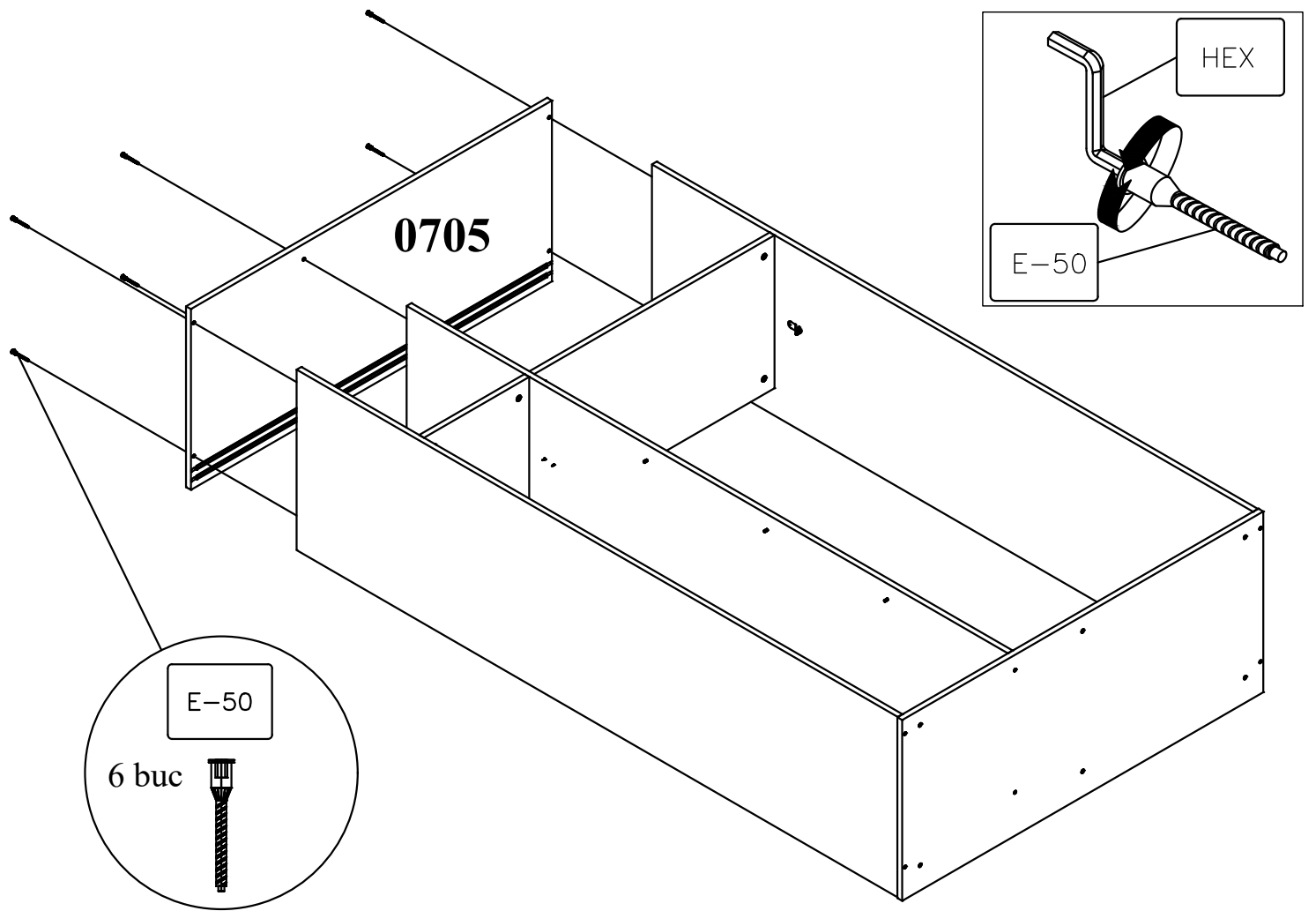

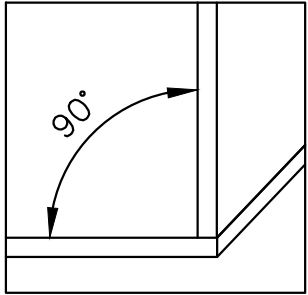
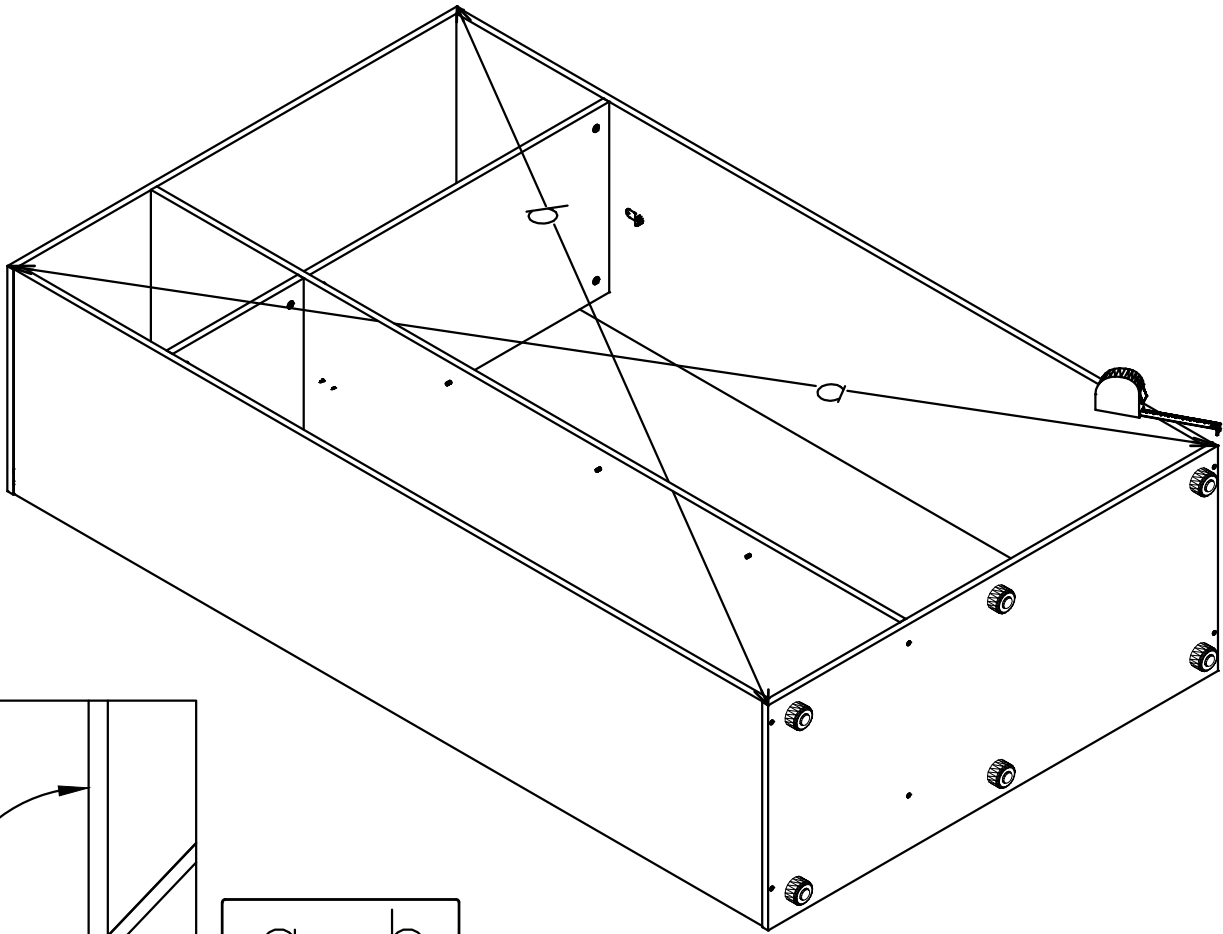

$a = b$

