



Termostat inteligent PNI CT36 fara fir cu WiFi, control prin Internet pentru centrale termice

Wireless smart thermostat PNI CT36 Internet controlled for central heating

Manual de utilizare / User manual



RO	Manual de utilizare.....	2
EN	User manual.....	8

ATENIONARI SPECIALE

Deoarece produsul trebuie conectat la o rețea de alimentare cu energie electrică 230 V și la un echipament de încălzire, instalarea trebuie făcută doar de către personal calificat, pentru a evita defectarea iremediabilă a produsului, și/sau a echipamentelor de încălzire la care se conectează, defecte care nu fac obiectul garanției.

Vă recomandăm ca pentru instalarea și configurarea inițială a echipamentului să apelați la personal calificat, cu experiență în domeniu, pentru înțelegerea corectă a termenilor și procedurilor tehnice detaliate în acest manual.

Utilizarea produsului este facilă, atât unitatea termostat mobilă cât și aplicația de smartphone având o interfață intuitivă și ușor de configurat și setat.

Pentru accesarea / monitorizarea / controlul produsului de la distanță de pe smartphone, este necesară prezența unei surse de internet (router WiFi) în încălțina în care este montat termostatul.

INFORMATII GENERALE

Termostatul inteligent PNI CT36 a fost dezvoltat pentru a oferi clienților un plus de confort zi de zi în spațiile de locuit, la birou sau în alte încălțini oferind posibilitatea de a monitoriza și porni / opri sistemele de încălzire fie automat programat pe perioade orare în fiecare zi a săptămânii, fie manual de la distanță, oricând și de oriunde prin intermediul Internetului și a aplicației dedicate pentru Smartphone cu Android sau iOS.

Mod de funcționare și comunicare:



Aplicația dedicată se numește TuyaSmart (sau SmartLife) și poate fi descărcată fie din Magazin Play / App Store, fie prin scanarea cu telefonul mobil a codului QR :



Produsul conține:

- unitate centrală cu ecran iluminat
- Unitate receptor/relev comandă
- Accesorii montaj perete / masă
- Manual de utilizare



Internet Router



DETALII TEHNICE / SPECIFICATII

- Alimentare unitate centrala: 2 baterii AAA
- Alimentare unitate receptor: 230VAC 50/60Hz
- Tip comanda unitate receptor : releu NO/NC (normal deschis/) fara potential (neenergizat)
- Parametri de functionare releu: maxim 250 V, maxim 10 Amperi (rezistiv), Curent AC/DC
- Compatibil cu toate centralele termice prevazute cu intrare termostat compatibil cu releu NO fara potential.
- Plaja temperatura reglabila/setabila : 5 - 35°C cu pas de 0.5°C
- Temperatura masurabila/afisabila: 0 - 50°C cu pas de 0.1°C
- Unitate de masura temperatura : doar grade °Celsius
- Umiditate acceptata: maxim 85% fara condens in aer
- Iluminare ecran : Da
- Senzor temperatura: NTC 10K, 3950ohms at 25°C
- Precizie senzor: $\pm 0.1^\circ\text{C}$ (calibrare senzor cu pas de 0.5°C)
- Grad de protectie: IP30
- Carcasa : ABS cu standard anti-incendiu UL94-5
- Conectivitate WiFi: 802.11 b/g/n (2.4 GHz) ; parola WPA2 (TKIP si AES)
- Conectivitate RF intre unitati : 868 MHz
- Compatibilitate aplicatie Smartphone: minim iOS 9 / minim Android 4.2

DESCRIERE UNITATE CENTRALA

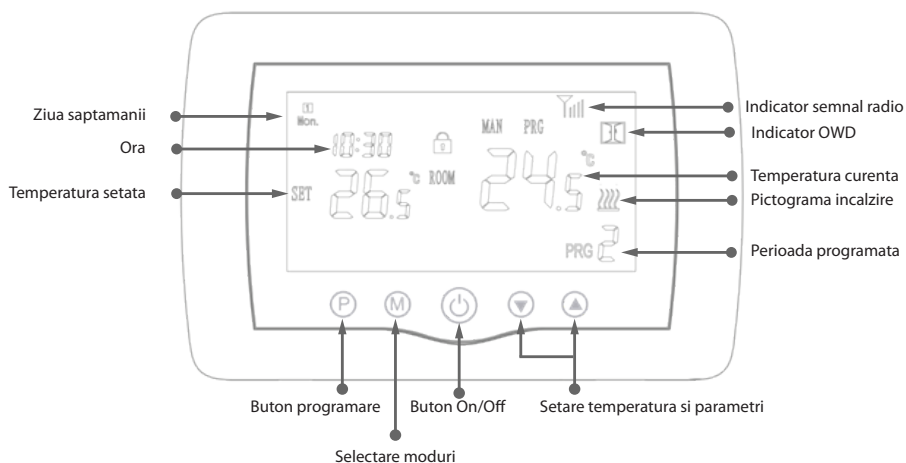

DESCRIERE UNITATE RECEPTOR

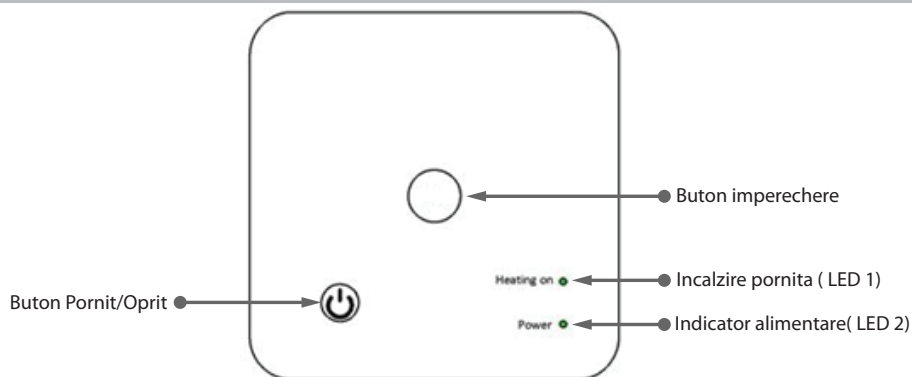

INSTRUCTIUNI SI ATENTIONARI LA PRIMA UTILIZARE:

1. Sistemul vine cu unitatile termostat si receptor imperecheate din fabrica. La instalare mai este necesara doar legarea / imperecherea unitatii receptor cu Router-ul Wireless din apropiere.
2. La prima punere in functiune termostatul / Unitatea receptor semnaleaza luminos prin LED = "clipeste rar" ca este necesara conectarea acesteia la router-ul wireless cu acces la internet.
3. Introduceti 2 baterii AAA alcaline (nu sunt incluse) in unitatile centrale si porniti unitatile apasand butonul ON/OFF (Pornit/Oprit). Pe ecran apar setarile conform descrierii de mai jos.
4. Conectati unitatea receptor la o sursa de alimentare 230 V (doar personal calificat). Asigurati-va ca functioneaza corect, testand/verificand starea ledului.

I. IMPERECHERE/LEGARE TERMOSTAT LA INTERNET PRIN WIRELESS CU APLICATIA DE MOBIL

1. Conectati telefonul mobil smartphone la reseaua wireless de internet din apropiere. Activati Locatia GPS pe smartphone daca nu este activata. Pentru o configurare rapida asigurati-va ca atat telefonul cat si termostatul si receptorul se afla cat mai aproape (1-3 m).
 1. Descarcati aplicatia "TuyaSmart" din Google Play sau App Store, apoi instalati si inregistrati un cont nou.
 2. Aducati dispozitivul apasand butonul + in coltul din dreapta sus.
 3. Apasati pe "All Devices" (Toate echipamentele) si accesati categoria Small Home Appliances.
 4. Gasiti "Thermostat" sau "Heater" din lista si selectati. Urmati pasii de pe ecran, verificati numele retelei Wireless si introduceti parola retelei Wireless cu acces la internet la care este conectat si telefonul.
 5. Apasati lung butonul imperechere de pe receptor pentru a intra in modul de conectare/legare Wifi, pana cand LED-ul 1 va clipi rapid. (LED-ul 1 clipeste rar, semn ca nu este legat la internet Wifi)
 6. Apasati casuta "Confirm indicator rapidly blink" pe telefon.
 7. Asteptati un moment pana la finalizarea conexiunii. LED-ul de pe receptor nu va mai clipi - ramane aprins. In acest moment conectarea la Internet prin Wireless este reusita si termostatul apare in lista de dispozitive in aplicatie.
- Daca LED-ul continua sa clipeasca incet, conexiunea nu a reusit, incercati din nou de la pasul 1.

PRIMA UTILIZARE A TERMOSTATULUI

1. Cu ecranul pornit, din unitatea termostat modificati temperatura setata mai sus sau mai jos decat temperatura masurata si afisata din camera.
 2. In maxim 90 de secunde unitatea termostat trimite comanda catre unitatea receptor, care confirma prin aprinderea/stingerea LED-ului 1 si in mod sonor printr-un "click", adica actionarea releului din interior. Vizual pe ecran veti constata aprinderea/stingerea pictogramei de incalzire.
 3. Din aplicatia de telefon "TuyaSmart" (asigurati-va ca dispozitivul apare online dupa configurarea la internet) si apasati pe unul din cele 2 termostate pentru a-l accesa. Folosind butoanele "+" sau "-" pentru a modifica temperatura dorita mai sus sau mai jos decat temperatura masurata in camera si afisata pe ecran.
 4. In maxim 90 de secunde aplicatia trimite comanda prin internet catre termostat/receptor care confirma in mod sonor printr-un "click"(adica actionarea releului din interior), si vizual prin aprinderea/stingerea LED-ului 1, dupa care apare/dispare si pe ecran pictograma de incalzire. Simultan se va modifica si temperatura afisata pe unitatea termostat conform comenzii.
- Daca modificarea nu are loc dupa 90 - 180 secunde (2 minute) verificati din nou:
- daca ati modificat temperatura mai sus/jos decat cea existenta in camera si afisata;
 - daca dispozitivul este online in aplicatie (Online - Culoare intensa; Offline - Culoare stearsa si mesaj de dispozitiv "Offline").
 - daca termostatul este conectat la receptor - verificati stare indicator semnal radio.

II. IMPERECHERE UNITATE TERMOSTAT CU UNITATEA RECEPTOR

ATENTIE: Daca unitatea receptor este conectata la Router/Internet puteti trece la acest pas doar daca este absolut necesar(constatati lipsa comunicarii) deoarece cele 2 unitati vin imperecheate din fabrica.

Daca unitatea receptor nu este conectata la Router/Internet este obligatoriu sa executati intai conectarea ei la Router/internet cu ajutorul aplicatiei de mobil.

Executati aceasta procedura doar daca este absolut necesar: daca legarea unitatii receptor la router-ul wireless a fost reusita dar unitatea termostat nu primeste/trimite timp de 5-10 minute comenzile trimise/

primite catre/de la la aplicatia de mobil iar pictograma  lipseste de pe ecran .

1. Apasati lung butonul de imperechere cod de pe receptor pana cand LED-ul 1 clipeste rapid.
2. Cu ecranul inchis (apasati butonul On/Off) apasati lung butonul M de pe unitatea centrala pana apare pe ecran un cod din 4 cifre. Apasati imediat butonul "sageata sus" pentru imperechere.
3. Led-ul 1 clipeste rar, asteptati cateva clipe pana LED-ul 1 nu mai clipeste. Pictograma  clipeste cateva clipe dupa care ramane pe ecran confirmand ca imperecherea este finalizata. Imperecherea este finalizata.
4. Opriti si porniti unitatea centrala, si testati functionalitatea modificand temperatura setata mai mare/mica decat pragul temperaturii citite.

III. STERGETI/ANULATI TOATE IMPERECHERILE

Pe unitatea receptor apasati si tineti apasat butoanele de imperechere si Pornit/Oprit timp de 5 secunde, pana cand LED1 si LED2 se aprind. Eliberati butoanele. Apoi se sting, ceea ce inseamna ca toate imperecherile au fost eliminate.

IV. SEMNAL SLAB SAU PIERDUT

In cazul pierderii / deconectarii semnalului RF (intre receptor si unitate termostat pictograma  va disparea de pe ecran (sau va clipi rar).

In cazul deconectarii de la reseaua Wifi (Internet) Ledul de pe unitatea receptor va clipi rar.

Apropiati unitatile una de alta, si unitatea receptor de router-ul WiFi si verificati din nou starea dispozitivelor. Daca in cateva minute functionarea nu revine la normal executati procedurile de imperechere ale receptorului cu unitatile termostat si apoi cu routerul wireless (cu ajutorul aplicatiei de mobil).

SETARE ORA DATA

Cu ecranul deschis apasati lung butonul M timp de 5-6 secunde, pana clipeste ora pe ecran.

Veti vedea evidentialt ora 00:00 pe ecran. Setati minutele cu butoanele sus si jos.

Continuati cu o apasare pe butonul M. Setati ora cu butoanele in sus si in jos.

Continuati cu o apasare pe butonul M. Selectati ziua cu butoanele sus si jos.

Continuati cu o apasare pe butonul M.

Salvati setarile apasand butonul ON / OFF sau asteptati aproximativ 15 secunde.

FUNCTIE DETECTIE GEAM DESCHIS

Cand modul de detectie "geam deschis" (OWD) este activat in setarile avansate, sistemul va opri automat incalzirea daca se inregistreaza o scadere brusca a temperaturii (2° C in 15 minute in mod implicit) iar pe ecran va aparea simbolul dedicat. Aceasta functie este utila cand se deschide o usa/fereastra(aerisire de exemplu) fara sa se opreasca incalzirea.

Aparatul va reveni la modul de functionare anterior dupa 30 de minute, iar simbolul va disparea de pe ecran. Orice alta apasare de buton in perioada de 30 de minute va opri functia, aducand sistemul la modul anterior/ programat de functionare.

ALTE FUNCTII DISPONIBILE IN APLICATIE

In aplicatia "TuyaSmart" aveti disponibile urmatoarele functii:

- Afisare temperatura masurata si temperatura programata / dorita / setata de utilizator;
- Afisare Stare Incalzire: Apare textul "Heating" cand caldura este pornita;
- 3 moduri de lucru: Manual, Eco (economic) si Automat (conform programarii zilnice)
- Blocare taste termostat , pentru a opri tastarea accidentala: Activati functia Seetings/Child Lock
- Programare zilnica (7 zile) cu 4 perioade orare in fiecare zi;
- Programare temporizata

CONFIGURARE PROGRAME ZILNICE



Aceasta configurare poate fi facuta si din aplicatia de smartphone, procedura pe care o recomandam.

De pe unitatea termostat cu ecranul aprins apasati lung butonul P (6-7 secunde) pentru a intra in setarile de PROGRAM. Zilele saptamanii sunt fixate de Luni pana Duminica (1 ~ 7), fiecare zi are 4 perioade de timp (1 ~ 4). Fiecare apasare a butonului P poate fi efectuata in setarea urmatoare.

- 1). Apasati P si tineti apasat timp de 3 secunde, afisajul "ora" clipeste, schimbati valoarea cu ajutorul butoanelor + si -.
- 2) Apasati butonul P, temperatura clipeste, modifica temperatura cu cea dorita prin butoanele + si -.
- 3). Apasati butonul P pentru perioada urmatoare.
- 4). Repetati in mod similar setarile pentru celelalte zile si perioade.

Perioada	1		2		3		4	
	Ora	Temp	Ora	Temp	Ora	Temp	Ora	Temp
12345 (Luni-Vin)	7:00	22°C	8:30	19°C	17:00	22°C	22:00	19°C
6 (Sambata)	8:00	22°C	8:30	22°C	17:00	22°C	22:00	19°C
7 (Duminica)	8:00	22°C	8:30	22°C	17:00	22°C	22:00	19°C

SETARI AVANSATE PARAMETRI

Opriti termostatul apasand butonul On/Off (Pornit/Oprit) . Cu ecranul stins apasati simultan butoanele  si  pentru setare avansata parametri.

MENIU	Descriere	Plaja valori	Valoare implicita
01	Calibrare temperatura senzor intern	-8°C ~ 8°C	0°C
02	Setare limita maxima temp.	5°C ~ 35°C	35°C
03	Setare limita minima temp.	5°C ~ 35°C	5°C
05	Temperatura protectie inghet	5°C ~ 15°C	5°C
09	Histerezis (Deadzone - cu pas 0.1°C)	0.2°C ~ 3°C	0°C (Oprit)
11	Funcctie protectie copii	1: Pornit 0: Oprit	0
12	Funcctie detectie geam deschis - OWD	1: Pornit 0: Oprit	0
13	OWD - Timp detectie	2 ~ 30 minute	15 minute
14	OWD - Scadere temperatura (in timpul de detectie)	2,3,4 °C	2°C
15	OWD - Timp Intarziere (revenire la setare/program anterior)	10 ~ 60 minute	30 minute
17	Revenire la setarile din fabrica	0 : Nu 1: Da, si apasati Butonul On/Off (Pornit Oprit) timp de 5 secunde pana se restarteaza termostatul.	0
	Versiune Software	5055-02	

DIAGRAMA CONEXIUNI UNITATE RECEPTOR

Operatiunea de conectare a unitatii receptor la o sursa de alimentare 230V si la o centrala termica se executa doar de catre personal calificat, si doar consultarea in prealabil a documentatiilor termostatului si

centralei termice.

Unitatea receptor are doua comenzi de tip releu (NO si NC / Normal Deschis si Normal Inchis) fara potential (neenergizat) ce executa inchiderea unui circuit de comanda cu un curent maxim de 10 A, si o tensiune acceptata maxima de 250 V AC / DC. Regasiti exemple de conectare cu anumite modele de centrale termice la sfarsitul manualului.

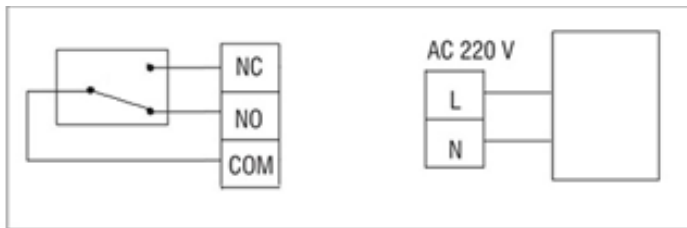

EXEMPLE DE CONECTARE CU CENTRALE TERMICE - THERMOSTAT PNI CT36*

*Instalarea trebuie facuta obligatoriu doar de catre instalator autorizat si doar dupa consultarea manualelor, si verificarea conexiunilor si compatibilitatea acestora.

1. Ariston CLAS EVO , ONE

Ariston CLAS ONE
TA1 - Termostat ambient connection

Receiver Termostat
KOPH CT99

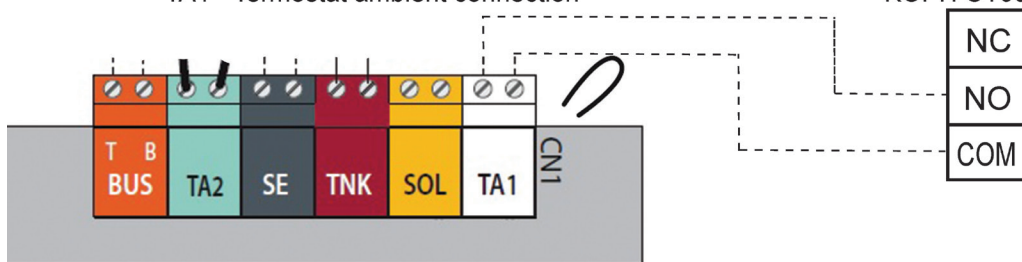

2. Ferroli DivaCondens 24/28

Receiver Termostat
PNI CT36

Ferroli DivaCondens F24/28
72 - Thermostat connection

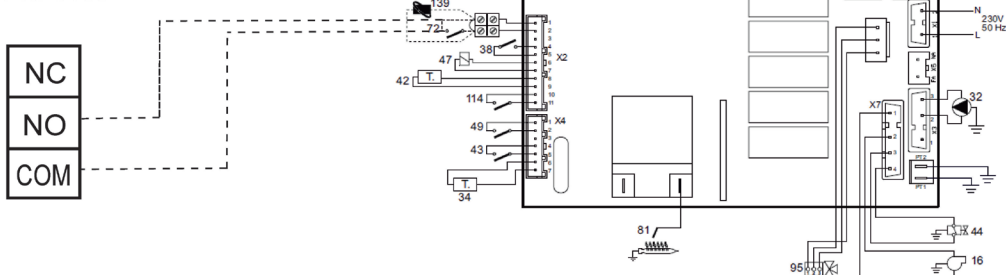

3. Vaillant Ecotec Pure

Receiver
Termostat
PNI CT36

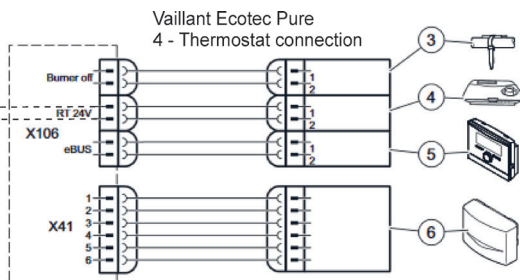
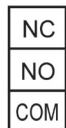

4. Motan Max Optimus

Receiver
Termostat
PNI CT36



Motan Max Optimus
TA - Thermostat connection

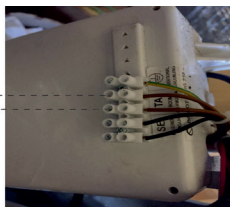

INSTALARE FIZICA SI DIMENSIUNI

Unitatea termostat poate fi montata in 2 moduri:

1. Pe masa sau pe o zona plana cu suportul alb prezent in colet:

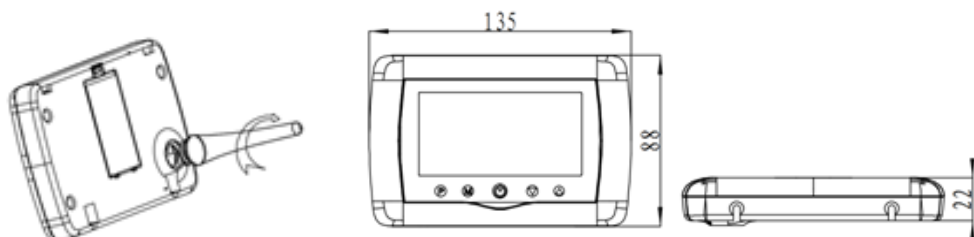

2. Pe perete cu suportul de perete inclus:



WARNINGS

Because the product must be connected to a 230 VAC power supply and to a heating appliance, installation should only be carried out by qualified personnel to avoid irreparable damage to the product and / or the heaters that are connected, defects not covered by warranty.

We recommend that you have qualified personnel with experience in this field, for initial setup of the equipment in order to understand correctly the technical terms and procedures detailed in this manual.

After installation and configuration, the product is easy to use both mobile unit and smartphone control with an intuitive and easy to configure interface.

To access / monitor / control the product remotely from your smartphone, it is necessary to have an internet source (WiFi router) close to where thermostat is installed.

GENERAL INFORMATIONS

The PNI CT36 smart thermostat has been developed to provide customers extra day-to-day comfort in their homes, in the office or other premises, offering the ability to monitor and turn on or off heating systems either automatically scheduled for every day of week, either remotely, anytime and anywhere via the Internet with dedicated app for Android or iOS Smartphone.

Mode of operation and communication:



Dedicated app name is TuyaSmart and can be downloaded either from the Google Play / App Store, either by scanning with your smartphone the QR code below :



Package content:

- Main unit with illuminated screen
- Receiver / 2 relay command unit
- Wall / table mount accessories
- User manual



Internet Router



TECHNICAL DETAILS / SPECIFICATIONS

- Main unit power supply: 2 AAA batteries
- Receiver power supply: 230VAC 50 / 60Hz
- Receiver unit command type: NO Relay (normally open) 10 Amps max not energized / dry contact
- Relay parameters: 250 V max, 10 Amps max (resistiv), AC/DC current
- Set point range temperature: 5 - 35°C (0.5°C step)
- Measurable ambient temperature: 0 - 50°C (0.1°C step)
- Temperature measurement unit: only °Celsius degrees
- Acceptable humidity: 85% no condensation
- Screen illumination: white light
- Temperature sensor: NTC 10K, 3950ohms at 25°C
- Sensor accuracy: ± 0.1 °C (0.5 °C step sensor calibration)
- Protection degree: IP30
- Housing: ABS with UL94-5 fire retardant plastic standard
- WiFi connectivity: 802.11 b / g / n (2.4 GHz); WPA2 (TKIP and AES)
- RF frequency connectivity between units: 868 MHz
- Smartphone Compatibility: Minimum iOS 9 / minimum Android 4.2

MAIN UNIT DESCRIPTION

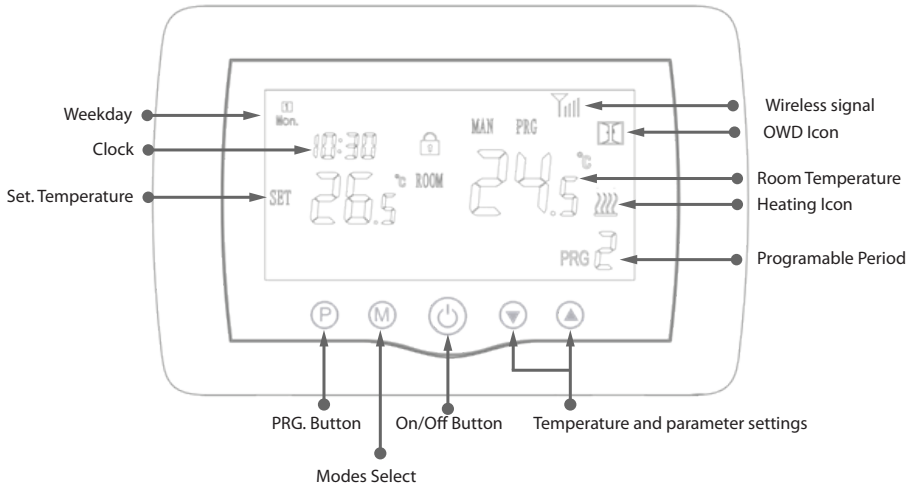

RECEIVER DESCRIPTION

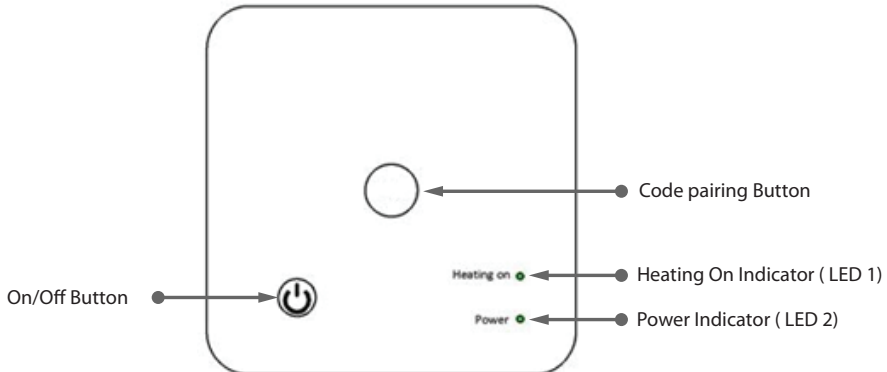

FIRST USE WARNINGS AND INSTRUCTIONS

1. The system comes with main unit and receiver paired from factory. Before use, you only need to pair the receiver unit with the nearby Wireless Router.
2. At first start, the thermostat / receiver unit signals by LED 1 = “ slow blinks” that means it is necessary to connect unit to the wireless router with Internet access.
3. Insert 2 AAA alkaline batteries (not included) into the main unit and turn it on by pressing the ON / OFF button. The settings appear as shown in above description.
4. Connect the receiver unit to a 230 VAC power supply (only qualified personnel). Make sure it works properly by testing / checking the LED status and turning unit On/Off by dedicated button.

I. PAIRING THERMOSTAT WITH MOBILE APP AND WIRELESS INTERNET ROUTER

1. Connect your smartphone to wireless Internet router nearby and activate GPS Location (if not active). For a quick setup make sure that phone, thermostat receiver and wireless router are as close as possible (1-3 m).
 1. Download “TuyaSmart” app from Google Play or App Store, and install and register a new account.
 2. Add device by pressing the + button in the top right corner.
 3. Press “All Devices” and access the Small Home Appliances category.
 4. Find “Heater” or “Thermostat” from list and select. Follow the on-screen steps, check the name of the Wifi network and enter the password of the Wifi network with internet access to which the phone is also connected.
 5. Long press the pairing button on the receiver to enter Wifi pairing mode until LED 1 blinks quickly. (before this, LED 1 blinks slow, sign that thermostat is not paired with wifi internet router).
 6. Tap the “Confirm indicator flash blink” on your phone.
 7. Wait a few moments until pairing is complete. The LED 1 on the receiver will stop blinking and turn off. At this point, connection to the Internet via Wirelessrouter is successful and the Thermostat icon will appear in Smartphone app.
- If the LED continues to blink slowly, the connection failed, try again from step 1

FIRST USAGE OF THERMOSTAT

1. With screen On, from thermostat main unit change the set temperature higher or lower than the measured and displayed temperature.
2. In maximum 90 seconds the thermostat unit sends the command to receiver unit, which confirms audibly with a “click” (the relay from inside) and visually on-screen by turning on/off the heating icon.
3. From the phone application “TuyaSmart” (make sure that the device appears online after setting up the internet) tap the thermostat to access it. Using the “+” and “-” buttons change the temperature higher or lower than measured and displayed temperature on screen.
4. In maximum 90 seconds the application sends the command via internet to the receiver unit, which confirms audibly with a “click”(the relay inside) after which the heating icon appears / disappears on screen. Simultaneously, the temperature displayed on the thermostat unit will change according to the command. If the change does not take after 90 - 180 seconds (2 minutes) check again:
 - if you have changed the temperature higher / lower than the measured one in the room and displayed;
 - if the device is online in the application (Online - Intense color; Offline - faded color and “Offline” message).
 - if the thermostat is connected to the receiver - check the status of the radio signal indicator, and the status of the thermostat in the mobile application (Online or Offline).

II. PAIR MAIN UNIT WITH RECEIVER UNIT

ATTENTION: If the receiver unit is connected to the Router / Internet you can go to this step only if it is absolutely necessary (notice the lack of communication) because the 2 units come paired from the factory.

If the receiver unit is not connected to the Router / Internet, it is mandatory to first connect it to the Router / Internet using the mobile application.

Perform this procedure only if absolutely necessary: if the connection of the receiver unit to the wireless router was successful but the thermostat unit does not receive / send for 5-10 minutes the commands sent /

received to / from the mobile application and the icon  is missing from screen.

1. Press and hold the code pairing button on the receiver until LED 1 flashes quickly.
2. With the screen closed (press the On / Off button), press and hold the M button on the center unit until a 4-digit code appears on the screen. Immediately press the “up arrow” button for pairing.
3. LED 1 flashes slowly, wait a few moments until LED 1 no longer flashes. The icon  flashes for a few moments after which it remains on the screen confirming that the pairing is completed.
4. Turn the central unit off and on, and test the functionality by changing the set temperature higher / lower than the showed temperature.

III. DELETE CLEAR ALL PAIRING

On receiver unit press and hold both pairing and On/Off buttons for 5 seconds until LED1 and LED2 turn on. Release buttons.
Then LED 1 turns off, which means that all pairing have been cleared.

IV. SIGNAL LOST OR WEAK

In case of loss / disconnection of the RF signal (between the receiver and the thermostat unit, the icon  will disappear from the screen (or blink rarely).

In case of disconnection from the Wifi network (Internet) The LED on the receiver unit will flash rarely.

Move the units closer to each other, and the receiver unit to the WiFi router and check the status of the devices again.

If in a few minutes the operation does not return to normal, perform the pairing procedures of the receiver with the thermostat units and then with the wireless router (with the help of the mobile application).

HOURLY/DATE SETTING

With main unit screen On, press and hold the M button for 5-6 seconds until the hour on the screen blinks. You will see highlighted 00:00 on the screen. Set the minutes with the up and down buttons.

Continue pressing the M button.

Set the time with the up and down buttons.

Continue pressing the M button.

Select the day with the up and down buttons.

Continue pressing the M button.

Save the settings by pressing the ON / OFF button or wait about 15 seconds.

OPEN WINDOW DETECTION FUNCTION

When the “open window” detection mode is activated in advanced settings, the system will automatically switch off heating if a sudden decrease in temperature (2°C in 15 minutes by default) occurs. This function is useful when opening a door / window (eg ventilation) without stopping the heating.

The thermostat will return to previous working mode after 30 minutes, and the “OP” icon will disappear from the screen. Press any button and thermostat will exit OWD function, during the heating off period.

OTHER FEATURES AVAILABLE IN YOUR SMARTPHONE APPLICATION

In TuyaSmart app you have the following features available:

- Measured temperature and programmed / set temperature by user;
- Heating Status: The “Heating” text appears on screen when the heat is on;
- 3 working modes: manual, Eco (economical) and automatic (according to daily schedule)
- Child lock function- Thermostat keyboard lock to stop accidental push of buttons
- Daily schedule (7 days) with 4 hour zones every day;
- Scheduled temperature timing



SET UP DAILY PROGRAMS

This setup can also be done from smartphone app, which we recommend. With the on-screen display, press and hold the P button (6-7 seconds) to enter the PROGRAM settings. Days of the week are fixed from Monday to Sunday (1 ~ 7), each day has 4 time periods (1 ~ 4). Each press of the P button can be performed in the next setting.

- 1). Press P and hold for 3 seconds, the "hour" display flashes, change the value with the + and - buttons.
- 2) Press the P button, the temperature blinks, change the desired temperature with the + and - buttons.
- 3). Press the P button for the next time.
- 4). Repeat the settings for the other days and periods similarly.

Period	1		2		3		4	
	Hour	Temp	Hour	Temp	Hour	Temp	Hour	Temp
12345 (Mon-Fri)	7:00	22°C	8:30	19°C	17:00	22°C	22:00	19°C
6 (Sat.)	8:00	22°C	8:30	22°C	17:00	22°C	22:00	19°C
7 (Sun.)	8:00	22°C	8:30	22°C	17:00	22°C	22:00	19°C

ADVANCED PARAMETER SETTINGS

Turn the thermostat screen Off by pressing the On / Off button. With screen Off, press and hold in the same time  and  button for parameters settings.

MENU	Description	Plaja valori	Valoare implicita
01	Temp. calibration for internal sensor	-8°C ~ 8°C	0°C
02	Set Point Max.	5°C ~ 35°C	35°C
03	Set Point Min.	5°C ~ 35°C	5°C
05	Frost Protection Temp.	5°C ~ 15°C	5°C
09	Hysteresis (Deadzone - 0.1°C step)	0.2°C ~ 3°C	0°C (Off)
11	Child protection	1: ON 0: Off	0
12	Open window detect function-OWD	1: ON 0: Off	0
13	OWD - Detect time	2 ~ 30 minutes	15 minutes
14	OWD - Drop temp. select (within detect time)	2,3,4 °C	2°C
15	OWD - Delay time select (Return to previous working status)	10 ~ 60 minutes	30 minutes
17	Factory reset	0 : No	0
		1: Yes, and then press On/off button for 5s, wait until thermostat restart.	
	Software Version	5055-02	

RECEIVER WIRING DIAGRAM

The operation of connecting the receiver unit with 230 V power supply and central heating system must be performed only by qualified personnel and only after consulting the thermostat and boiler documentation.

The receiver unit has a relay type controls (NO and NC / Normal Open and Normal Closed) without potential (non-energized) that executes the closing of a control circuit with a maximum current of 10 A, and

a maximum accepted voltage of 250 V AC / DC . Find examples of connections with certain models of Gas boiler Systems at the end of the user manual.

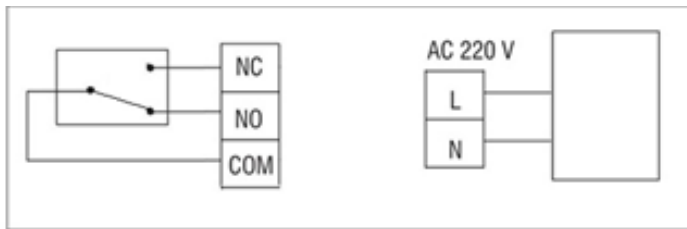

CONNECTION EXAMPLES WITH GAS BOILER SYSTEMS- THERMOSTAT PNI CT36*

* The installation must be done only by authorized installer and only after consulting the user manuals, and checking the connections and their compatibility.

1. Ariston CLAS EVO , ONE

Ariston CLAS ONE
TA1 - Termostat ambient connection

Receiver Termostat
PNI CT36

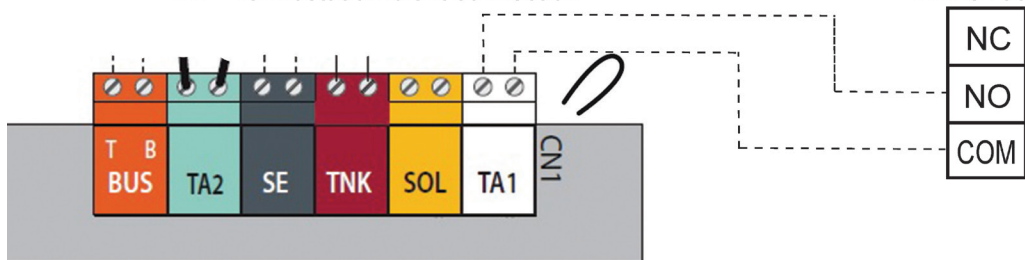

2. Ferroli DivaCondens 24/28

Receiver
Termostat
PNI CT36

Ferroli DivaCondens F24/28
72 - Thermostat connection

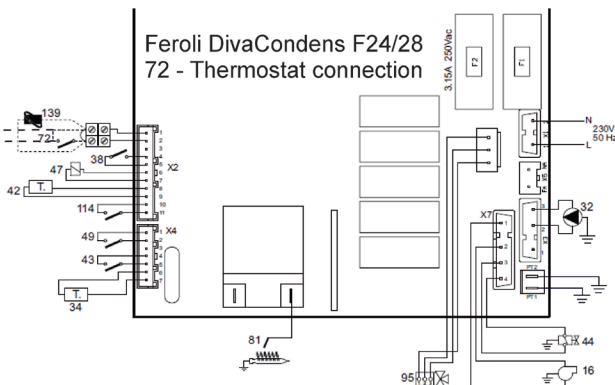
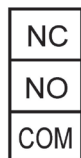

3. Vaillant Ecotec Pure

Receiver
Termostat
PNI CT36

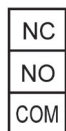

Vaillant Ecotec Pure
4 - Thermostat connection

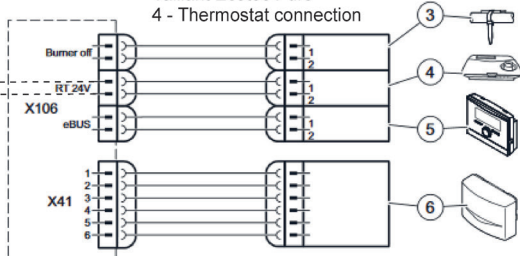

4. Motan Max Optimus

Receiver
Termostat
PNI CT36



Motan Max Optimus
TA - Thermostat connection

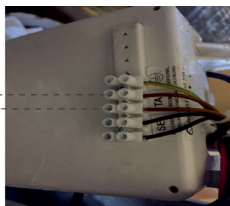

INSTALLATION AND DIMENSIONS

The main and receiver unit can be mounted in 2 ways:

1. Table or flat surface area with the white holder inside package:

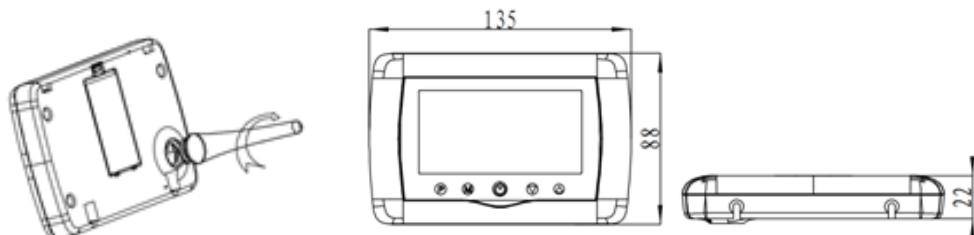

2. On the wall with wall holder plate:

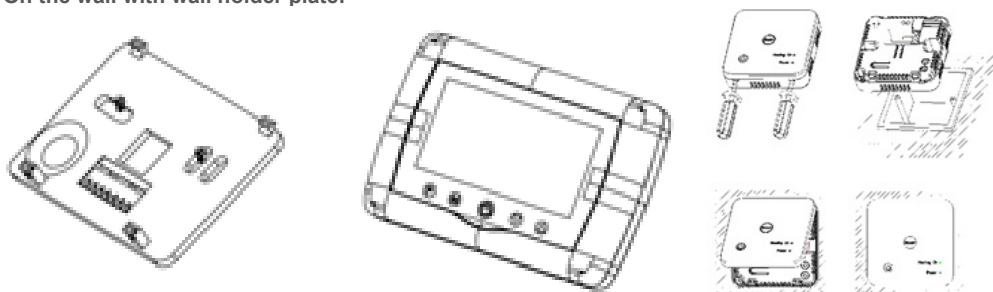

Опростена декларация за съответствие на ЕС

SC ONLINESHOP SRL декларира, че **Интелигентен термостат PNI CT36** спазва директивата EMC 2014/30/EU и LVD 2014/35/EU и RED 2014/53/UE. Пълният текст на ЕС декларацията за съответствие е достъпен на следния интернет адрес:

<https://www.mypni.eu/products/7068/download/certifications>

EU Simplified Declaration of Conformity

SC ONLINESHOP SRL declares that **Smart thermostat PNI CT36** complies with the Directive EMC 2014/30/EU and RED 2014/53/UE and LVD 2014/35/EU. The full text of the EU declaration of conformity is available at the following Internet address:

<https://www.mypni.eu/products/7068/download/certifications>

Vereinfachte EU- Konformitätserklärung

SC ONLINESHOP SRL erklärt, dass das **Intelligenter Thermostat PNI CT36** der Richtlinie EMC 2014/30/EU entspricht, Richtlinie RED 2014/53/UE entspricht und Richtlinie LVD 2014/35/EU entspricht . Sie finden den ganzen Text der EU-Konformitätserklärung an der folgenden Internetadresse:

<https://www.mypni.eu/products/7068/download/certifications>

Declaración UE de conformidad simplificada

SC ONLINESHOP SRL declara que el **Termostato inteligente PNI CT36** cumple con la Directiva EMC 2014/30/EU, la Directiva RED 2014/53/UE y la Directiva LVD 2014/35/EU. El texto completo de la declaración de conformidad de la UE está disponible en la siguiente dirección de Internet:

<https://www.mypni.eu/products/7068/download/certifications>

Déclaration de conformité simplifiée de l'UE

SC ONLINESHOP SRL déclare que **Thermostat intelligent PNI CT36** est conforme à la directive EMC 2014/30/EU, RED 2014/53/UE et LVD 2014/35/EU . Le texte complet de la déclaration de conformité UE est disponible à l'adresse Internet suivante:

<https://www.mypni.eu/products/7068/download/certifications>

Egyszerűsített EU Megfelelési Közlemény

SC ONLINESHOP SRL kijelenti azt, hogy a **Intelligens termosztát PNI CT36** megfelel az EMC 2014/30/EU, RED 2014/53/UE és LVD 2014/35/UE irányelvnek. Az EU-megfeleléségi nyilatkozat teljes szövege a következő internetes címen érhető el:

<https://www.mypni.eu/products/7068/download/certifications>

Dichiarazione UE di conformità semplificata

SC ONLINESHOP SRL dichiara che il **Termostato intelligente PNI CT36** è conforme alla direttiva EMC 2014/30/UE, alla direttiva RED 2014/53/UE e alla direttiva LVD 2014/35/UE. Il testo completo della dichiarazione di conformità europea è disponibile al seguente indirizzo Internet:

<https://www.mypni.eu/products/7068/download/certifications>

Uproszczona deklaracja zgodności UE

SC ONLINESHOP SRL oświadcza, że **Inteligentny termostat PNI CT36** jest zgodny z dyrektywą EMC 2014/30/EU, RED 2014/53/UE i LVD 2014/35/EU . Pełny tekst deklaracji zgodności UE dostępny jest pod następującym adresem internetowym:

<https://www.mypni.eu/products/7068/download/certifications>

Declaratie UE de conformitate simplificata

SC ONLINESHOP SRL declara ca **Termostat inteligent PNI CT36** este in conformitate cu Directiva EMC 2014/30/EU, Directiva RED 2014/53/UE si Directiva LVD 2014/35/EU. Textul integral al declaratiei UE de conformitate este disponibil la urmatoarea adresa de internet:

<https://www.mypni.eu/products/7555/download/certifications>