



MOTOSAPĂ SEMIPROFESIONALĂ DAC 6500K / ACC





CUPRINS

1. Introducere	4
2. Instrucțiuni de siguranță	5
2.1 Atenționări pe utilaj	5
3. Prezentare generală a utilajului	6
4. Date tehnice	7
5. Montajul	8
6. Alimentarea cu combustibil și ulei	13
6.1 Alimentarea cu ulei	13
6.2 Alimentarea cu combustibil	15
7. Verificări pre-operare	15
8. Perioada de rodaj	16
9. Punerea în funcțiune	16
10. Simptomatică probleme pornire	19
11. Întreținere	19
12. Ambalarea și depozitarea utilajului	20
12.1 Ambalarea	20
12.2 Depozitarea	21
13. Accesorii compatibile cu utilajul	22
14. Cuplarea accesoriilor	24
14.1 Cuplare plug	24



14.2	Cuplare dispozitiv de scos cartofi	25
14.3	Cuplare cultivator	26
14.4	Cuplare rariță reglabilă	27
14.5	Cuplare remorcă	28
14.6	Cuplare pompa de apă	29
14.7	Cuplare semanatoare pe 3 randuri TS3.....	30
14.8	Cuplare semănătoare precizie înalta PTS2	31
14.9	Cuplare lama de zăpadă	32
15.	Cuplare suport reglaj adâncime si plug de Îngropat	33
15.1	Sistem de cosit CRT.....	34
16.	Declarații de conformitate	35



1. INTRODUCERE

Stimate client!

Îți mulțumim pentru decizia de a cumpăra un produs RURIS și pentru încrederea acordată companiei noastre! RURIS este pe piață din anul 1993 și în tot acest timp a devenit un brand puternic, care și-a construit reputația prin respectarea promisiunilor, dar și prin investițiile continue menite să vină în ajutorul clienților cu soluții fiabile, eficiente și de calitate.

Suntem convingși că veți aprecia produsul nostru și vă veți bucura de performanțele sale timp îndelungat. RURIS nu oferă clienților săi doar utilaje, ci soluții complete. Un element important în relația cu clientul este consilierea atât înainte de vânzare, cât și post vânzare, clienții RURIS având la dispoziție o întreagă rețea de magazine și puncte service partener.

Pentru a vă bucura de produsul cumpărat, vă rugăm să parcurgeți cu atenție manualul de utilizare. Prin respectarea instrucțiunilor, o să aveți garanția unei utilizări îndelungate. Compania RURIS lucrează continuu pentru dezvoltarea produselor sale și de aceea își rezervă dreptul de a modifica printre altele forma, înfățișarea și performanțele acestora, fără a avea obligația de a comunica acest lucru în prealabil.

Vă mulțumim încă o dată că ați ales produsele RURIS!

Informații și suport clienți:

Telefon: 0351.820.105

e-mail: info@ruris.ro



2. INSTRUCȚIUNI DE SIGURANȚĂ

2.1 ATENȚIONĂRI PE UTILAJ



Avertizare! Pericol!



Citiți manualul de instrucțiuni înainte de utilizarea acestor utilaje.



Operatorul trebuie să poarte Echipament Personal de Protecție (PPE). Dacă mașina este în uz, trebuie să purtați ochelari de protecție împotriva obiectelor proiectate în aer; trebuie purtate elemente de protecție a auzului cum ar fi casca izolată acustic.



Nu deteriorați manualul. Pastrați-l pentru consultări ulterioare.



Pericol energie electrică.



Nu folosiți soluții inflamabile în apropierea utilajului.



Evitați contactul cu elementele în mișcare ale utilajului.



Evitați zonele cu temperaturi ridicate ale utilajului.



Nu porniți utilajul în spații închise.



3. PREZENTARE GENERALĂ A UTILAJULUI

Motosapa este compusă din următoarele elemente:

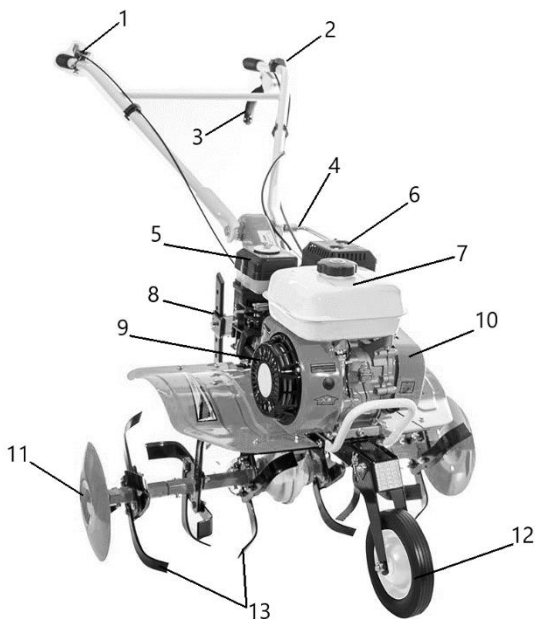

1. Manetă accelerație

6. Tobă eșapament

11. Taler

2. Comutator On/Off

7. Rezervor combustibil

12. Roată transport

3. Manetă cuplare ambreiaj

8. Suport reglaj adâncime

13. Cuțite tăietoare

4. Manetă reglaj coarne

9. Demaror

5. Filtru de aer

10. Apărătoare curea



4. DATE TEHNICE

ATENȚIONARE:

Motosapa nu este livrată cu ulei în unitatea motor. Înainte de punerea în funcțiune, verificați și completați cu ulei recomandat pentru motor, conform instrucțiunilor din manual.

În baia de ulei a motorului există ulei sub nivel, acesta fiind doar pentru conservare și nu pentru funcționare.

Model	DAC 6500K/ DAC 6500ACC
Greutate (cu cuțite)	80 kg
Motor	4 timpi
Producător motor	General Engine
Capacitate cilindrică	208 cmc
Putere	7 CP/5.2 kW
RPM	Max 3600 Min 2000
Consum litri/h	250 ml/kwh
Combustibil	Benzină fără plumb

Folosiți utilajul în scopul pentru care a fost conceput, folosind doar accesoriile originale RURIS. Orice altă utilizare ar putea fi periculoasă și ar putea dăuna echipamentului. A nu se utiliza pentru a cultiva un teren care conține roci, pietre, sârme sau orice alte materiale dure.

Schimbați uleiul de motor la fiecare 25 ore de funcționare, iar la transmisie la fiecare 50 ore de funcționare sau 6 luni



5. MONTAJUL

Montajul video poate fi vizionat la adresa : <https://www.ruris.ro/filme-montaj>

Piese componente

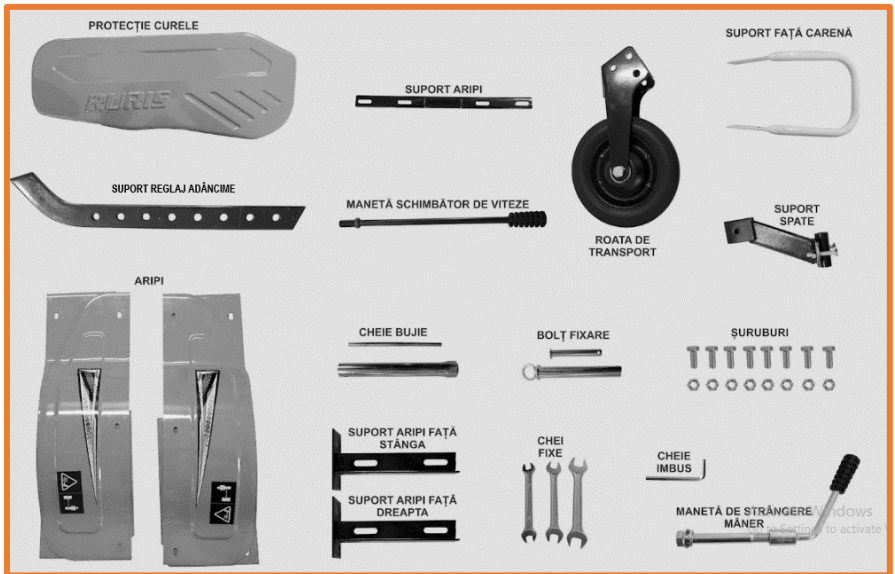



Montați suportul față și suporturile aripilor stânga / dreapta.

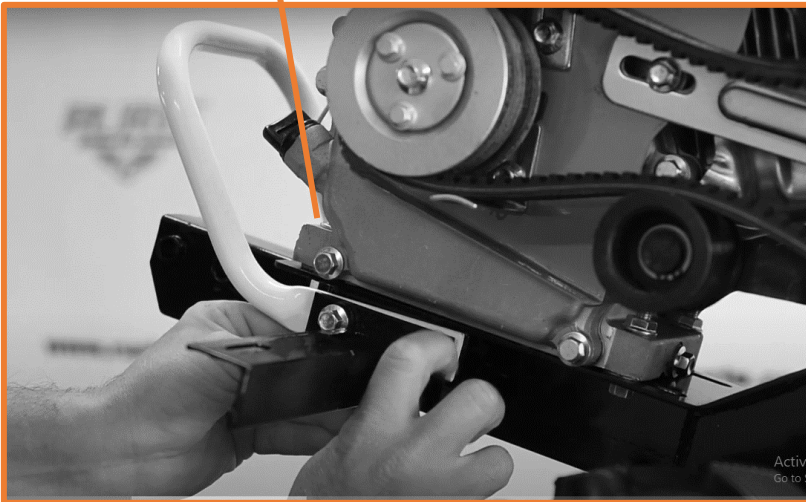



Montați roata față și asigurați cu șurub + bolt



Montați coarnele și fixați-le cu maneta de strângere mâner. (în funcție de modelul de coarne)

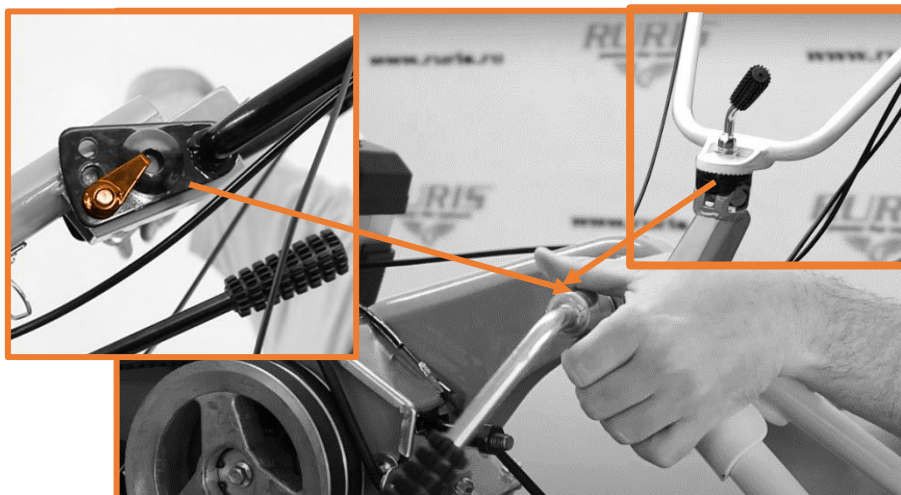



Montați suportul din spate al aripilor.



Montați airpile de protecție.



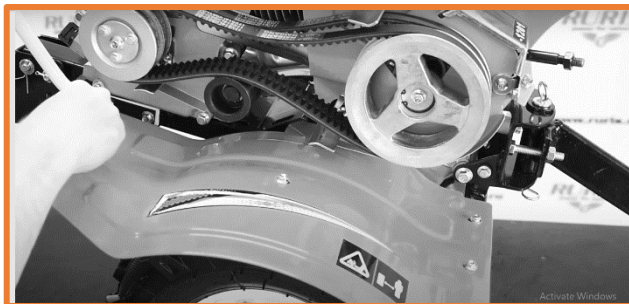

Schimbatorul de viteze se montează și se blochează cu ajutorul bolțului – siguranței.

Pentru a realiza acest lucru este necesară demontarea fulei folosind o cheie inelară.

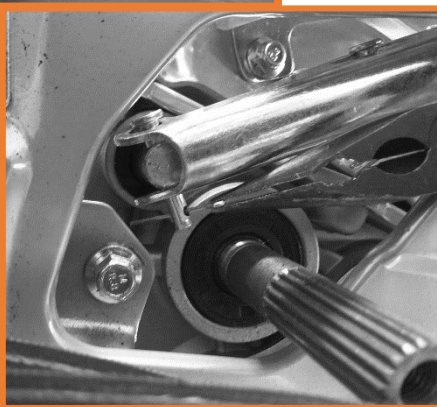
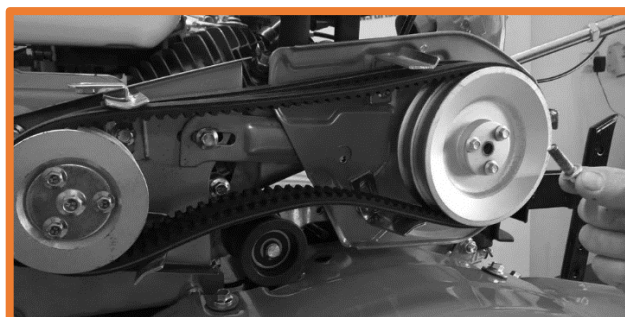



Imaginile sunt cu caracter informativ, furnizorul își rezervă dreptul de a aduce modificări structurale și funcționale față de utilajul prezentat în acest manual.

6. ALIMENTAREA CU COMBUSTIBIL ȘI ULEI

6.1 ALIMENTAREA CU ULEI

Alimentarea cu ulei a motorului

Înainte de pornirea motorului, alimentați motorul cu ulei RURIS 4T-MAX sau un ulei de clasificare API: CI-4/SL ori superioara acesteia.

Motosapa nu se livrează cu ulei în motor.

Capacitate baie ulei motor 0,6L



ATENȚIONARE:

- Nu utilizați mersul înapoi pentru săpat sau transport pe o distanță mai lungă de 10m, pentru o singură acționare.
- Verificați dacă nivelul de ulei este corect, prin desfiletarea bușonului (joja de ulei) situat pe carterul motor și observați dacă uleiul ajunge până la primul filet de sus, la partea superioară de umplere. Verificarea se realizează având motorul poziționat în plan orizontal.



ATENȚIONARE:

Întotdeauna, înainte de fiecare pornire trageți ușor de cel mult 4 ori de sfoara demarorului de la motor (butonul de pornire pe pozitia OFF) pentru ca uleiul să pătrundă în toate orificiile cilindrilor, supapelor.

În caz contrar, dacă încercați pornirea bruscă a motorului prin tragere directă a sfoarii demaror, riscați griparea motorului sau avarierea gravă a acestuia.

Alimentarea cu ulei a transmisiei

Capacitatea băii de ulei a transmisiei este de 1600 ml.

Folosiți ulei de transmisie RURIS G-Tronic sau un ulei de clasificare API: GL-4 ori superioară acesteia. Nivelul maxim de ulei al reductorului este la partea inferioară a orificiului de alimentare situat pe partea dreaptă a reductorului.



Motosapa nu este livrată cu ulei în baia reductorului.

SCHIMBUL DE ULEI LA TRANSMISIE SE FACE LA FIECARE 50 ORE FUNCȚIONARE

6.2 ALIMENTAREA CU COMBUSTIBIL

Folosiți combustibil de calitate din stații Peco autorizate.

Alimentați cu combustibil tip BENZINĂ FĂRĂ PLUMB de cea mai bună calitate, folosind o pâlnie de metal, în spații deschise și departe de surse de foc sau scânteii, care ar putea provoca un incendiu.

ATENȚIONARE:

Nu alimentați pe sol sau în preajma plantelor, deoarece riscați deteriorarea mediului înconjurător.

7. VERIFICĂRI PRE-OPERARE

1. Verificați dacă toate șuruburile sunt strânse și ajustați-le dacă este cazul.
2. Verificați fiecare mâner al ghidonului (maneta de accelerație, schimbătorul de viteze și marșarier) pentru a verifica funcționalitatea lor. Dacă pozițiile mânerelor sunt incorecte, reglați-le pentru a fi în pozițiile corespunzătoare.
3. Mutați schimbătorul de viteze în poziția neutră.
4. Completarea uleiului.
 - Umpleți baia de ulei a motorului cu ulei de lubrifiere RURIS 4T- MAX.
 - Așezați utilajul pe o suprafață plană în timp ce alimentați cu ulei de transmisie în cutia de viteze.
 - Pentru a verifica nivelul de ulei folosiți joja de ulei, uleiul trebuie să fie la nivel maxim.
 - Verificați scurgerile de ulei.
 - Adăugați ulei în filtrul de aer .
5. Curățați unitatea de praf și murdărie, în special filtrul de aer.



8. PERIOADA DE RODAJ

Motosapa trebuie să funcționeze 5 ore în sarcină ușoară. După această perioadă, faceți schimbul de ulei atât la transmisie cât și la motor. Alimentați apoi baia de ulei a transmisiei cu ulei RURIS G-Tronic sau un ulei de clasificare API: GL-4 ori superioară acesteia, cât și baia de ulei a motorului cu ulei RURIS 4T-MAX sau un ulei de clasificare API: CI-4/SL ori superioară acesteia.

La motosapă se va folosi benzină fără plumb.

Recomandat este ca înainte de utilizare, benzina să fie decantată și filtrată prin sită metalică.

9. PUNEREA ÎN FUNCȚIUNE

Este interzis mersul motorului la ralanti fără sarcină, mai mult de 5 minute deoarece riscați să deteriorați curelele de transmisie.

Motorul care echipează motosapa dumneavoastră are rodajul făcut în fabrică și nu necesită rodaj la ralanti.

Înainte de a pune în funcțiune Motosapa, trebuie să vă asigurați că următoarele condiții sunt îndeplinite :

- umpleți recipientul filtrului de aer cu ulei curat de motor, până la nivelul maxim indicat
- pe o rază de 5 metri de o parte și de alta a motosapei, nu sunt persoane sau obiecte cu care aceasta ar putea intra în contact
- motosapa este așezată în poziție orizontală
- roata frontală este montată și ridicată față de sol
- motorul are ulei în baie la nivel maxim
- cutia de viteze are uleiul la nivel maxim
- motorul are un minim de 500 ml benzină în rezervor



- cuțitele tăietoare sunt asigurate cu bolțurile de fixare sau, dacă se montează roțile de transport, acestea sunt asigurate cu bolțurile de fixare, iar presiunea în anvelopă este cuprinsă între 1,5-2 bar
- toate șuruburile motosapei sunt strânse corespunzător

Pornirea motorului

- poziționați clapeta de șoc în sensul indicat pentru pornirea la rece.

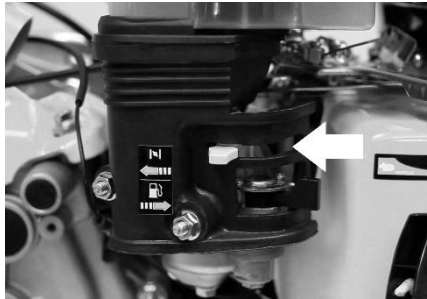

Poziționați clapeta robinetului de benzină în sensul indicat.

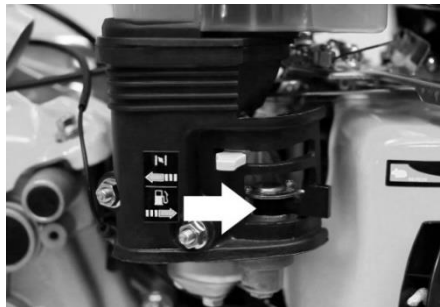

- trageți de 4 ori, ușor, la sfoara demaror, pentru a amorsa cu ulei toate orificiile interne ale motorului
- acționați la maxim maneta de accelerație (în poziția H)
- puneți butonul PORNIT/OPRIT pe poziția ON



- trageți constant și ferm la sfoara demaror de la motor, după pretensionarea acesteia (trageți ușor până întâmpinați rezistența compresiei motorului)
- poziționați schimbătorul în treapta dorită și cu mâna stângă acționați prin strângere maneta de acționare a cuțitelor tăietoare. Acestea vor începe să se rotească
- deplasați ușor până la capăt de cursă în sensul opus clapeta de șoc, până când motorul funcționează la parametrii, adică nu are simptome de oprire

ATENȚIONARE:

Eliberați maneta de acționare a cuțitelor tăietoare și acestea se vor opri.

În cazul în care auziți un zgomot continuu de patinaj la cuplare, sau dacă motosapa nu se deplasează, verificați încă o dată cablul de acționare al cuțitelor tăietoare, deoarece acesta a fost reglat pe o cursă scurtă.

NOTĂ:

Cuplarea trebuie să se facă întotdeauna la turația maximă a motorului, deoarece, în caz contrar riscați deteriorarea curelei.

În acest moment puteți începe operația de săpat a solului.



10. SIMPTOMATICĂ PROBLEME PORNIRE

- verificați dacă uleiul în motor este la nivel, deoarece motorul care echipează motosapa dumneavoastră poate fi dotat cu un senzor de ulei care întrerupe scânteia la bujie în cazul în care acesta nu este la nivel maxim în motor
- verificați dacă robinetul de combustibil este deschis în poziția indicată
- verificați dacă aveți combustibil în rezervor și dacă este corespunzător (sa nu fie alt fel de combustibil decât cel indicat sau cu vechime mai mare de 1-2 săptămâni)
- verificați dacă maneta de accelerație este acționată la maxim
- verificați dacă clapeta de șoc este acționată pe poziția închis
- verificați dacă filtrul de aer nu este îmbâcsit cu impurități
- schimbați bujia cu o bujie nouă

11. ÎNTREȚINERE

- după fiecare utilizare curățați filtrul de aer și înlocuiți uleiul din camera filtrului, cu unul curat, la nevoie, sau odata cu înlocuirea uleiului din motor.
-

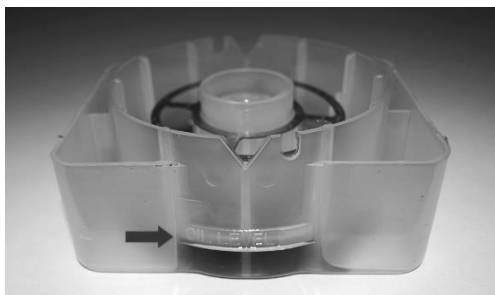

- după fiecare utilizare curățați cuțitele tăietoare și verificați-le
- după fiecare utilizare ungeți cu vaselină axul pe care sunt fixate cuțitele tăietoare
- reglați cablurile în cazul în care sesizați că cuțitele nu răspund la comenzi sau se opresc în sarcină
- schimb ulei transmisie/motor la fiecare 50/25 ore de funcționare sau 6 luni.



Montarea/demontarea curelei de antrenare a transmisiei

Aceasta se face după cum urmează:

- demontarea capacului lateral al carcasei de protecție
- demontarea efectivă a curelei
- montarea noii curele de transmisie
- montarea capacului de protecție

În cazul în care demontați întinzătorul curelei, aceasta va fi montată și aliniată, după noua curea prin păstrarea poziției inițiale a bușei de reglaj sau rotirea acesteia la 180 grade conform pasului 7 din ghidul de montaj, astfel aceasta va fi pe aceeași axă, protejând și nedeteriorând cureaua de transmisie.

NOTĂ:

Înlocuirea fulliilor se va face numai în Service autorizat, deoarece acestea au strângeri diferite a șuruburilor care le fixează.

În cazul în care după o perioadă îndelungată de lucru, întinzătorul nu mai funcționează la maximum, cureaua patinând în sarcină, se va efectua reglajul cablului de acționare.

12. AMBALAREA ȘI DEPOZITAREA UTILAJULUI

12.1 AMBALAREA

Ambalarea este făcută în cutii de carton, închise, pentru o deplasare ușoară.

În interiorul acesteia găsiți:

- manualul de utilizare
- certificatul de garanție
- motosapa
- trusa de chei











12.2 DEPOZITAREA

- Motosapa trebuie să fie depozitată într-un loc uscat, cu acoperiș și protejată contra umezelii, în încăperi cu geamuri și ventilație corespunzătoare
- Carburantul trebuie golit din rezervor, se închide robinetul de benzină și se lasă utilajul să funcționeze până se consumă tot combustibilul din carburator.
- Părțile metalice active trebuie unse cu vaselină
- Trebuie lăsat uleiul în baia motorului pe timpul depozitării
- Uleiul de motor trebuie înlocuit, dacă motosapa a fost depozitată mai mult de 6 luni.



13. ACCESORII COMPATIBILE CU UTILAJUL

<p>Rariță reglabilă</p> 	<p>Plug de îngropat (rariță) TS103</p> 	<p>Dispozitiv de scos cartofi TS</p> 
<p>Cultivator TS103</p> 	<p>Cultivator multifuncțional cu două rarițe</p> 	<p>Lamă de zapadă</p> 
<p>Semănătoare precizie înaltă PTS2</p> 	<p>Semănătoare pe 3 rânduri TS3</p> 	<p>Set roți cauciuc 400x8 TS103</p> 



<p>Set roți metalice 350 TS 103</p> 	<p>Set roți metalice 400 TS 103</p> 	<p>Reductor TS100</p> 
<p>Set manicot universal cu blocator TS103</p> 	<p>Set manicot universal TS103</p> 	<p>Set manicot cu blocator CRT280</p> 
<p>Pompă apă pentru motosăpătoare</p> 	<p>Remorcă: Încarcatură: 550 kg</p> 	<p>Remorcă: Încarcatură: 450 kg</p> 
<p>Accesoriu tractat Navigator 88</p> 	<p>Sistem de cosit cu tambur CRT570</p> 	<p>Adaptor accesorii</p> 



14. CUPLAREA ACCESORIILOR

14.1 CUPLARE PLUG

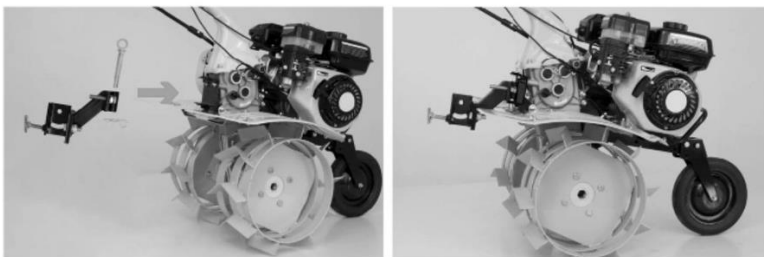

1. Se montează adaptorul de accesorii și se fixează cu bolț.

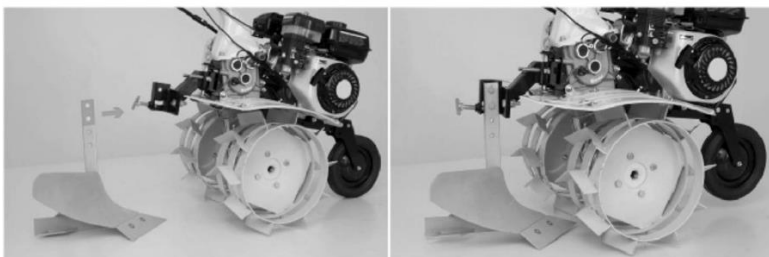

2. Se cuplează plugul pe adaptor și se fixează cu două șuruburi.



14.2 CUPLARE DISPOZITIV DE SCOS CARTOFI

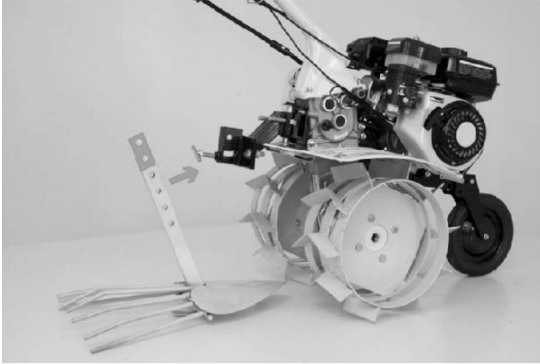

1. Se folosește adaptorul de accesorii

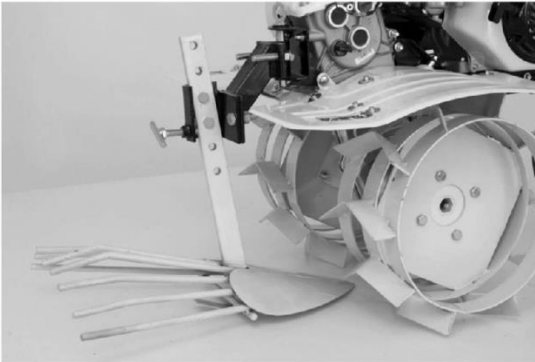

2. Se montează dispozitivul de scos cartofi și se fixează cu două șuruburi



14.3 CUPLARE CULTIVATOR

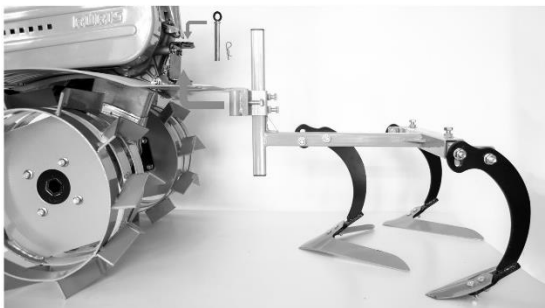

1. Cultivatorul se cuplează folosind bolțul și siguranța din dotare





14.4 CUPLARE RARIȚĂ REGLABILĂ

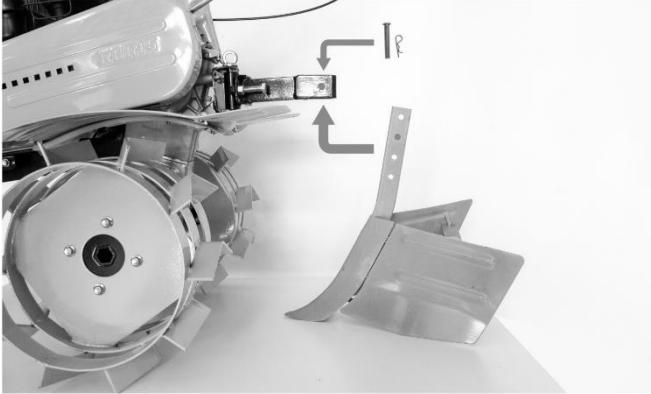

1. Rarița se cuplează folosind bolțul și siguranța din dotare

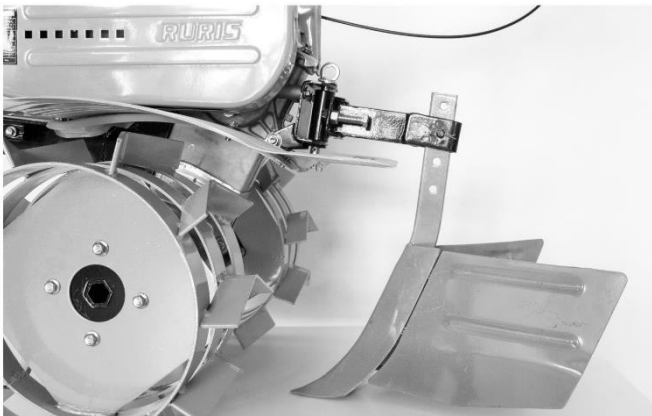



14.5 CUPLARE REMORCĂ

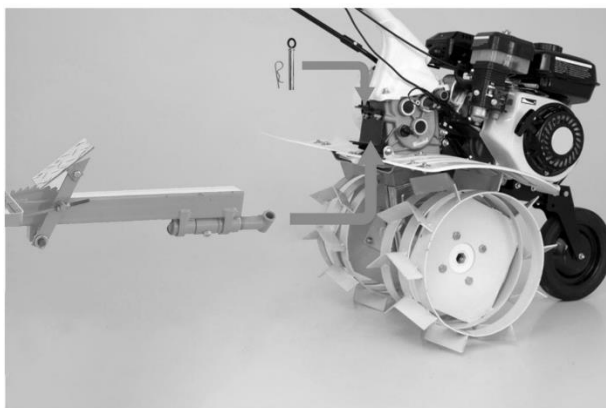

1. Remorca se cuplează folosind bolțul și siguranța din dotare

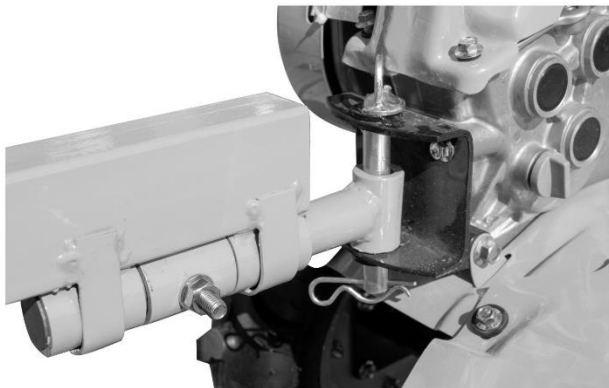



14.6 CUPLARE POMPA DE APĂ

Pasul 1

Se detașează mânerul motosapei, apoi se montează piciorul pompei cu ajutorul celor 2 șuruburi. În prealabil se montează șurubul de reglare al curelelor.

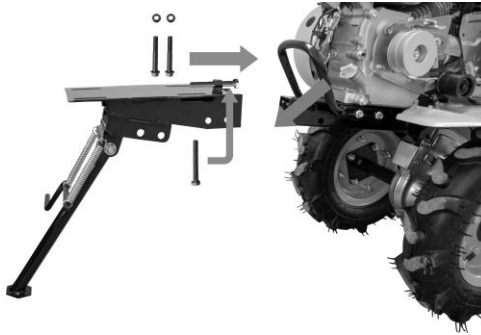

Pasul 2

Se montează corpul pompei cu ajutorul celor 4 șuruburi.

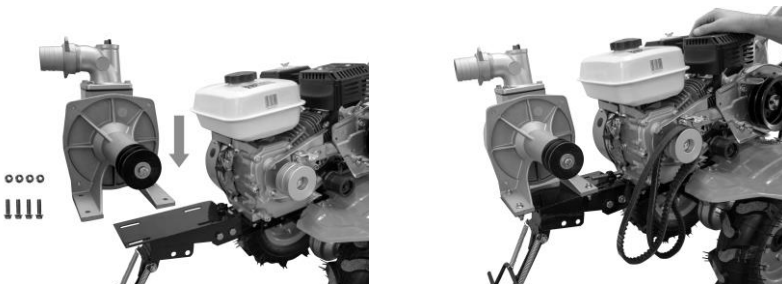



Pasul 3

Se montează cele două curele și se reglează cu ajutorul șurubului.

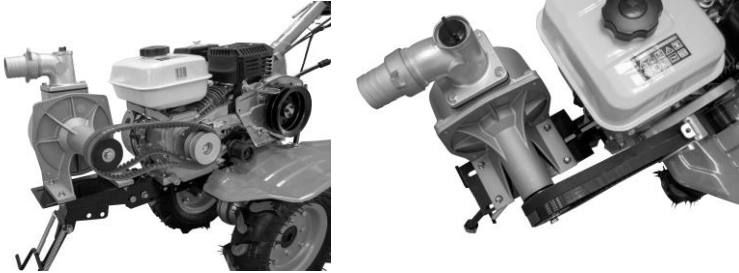

14.7 CUPLARE SEMANATOARE PE 3 RANDURI TS3

1. Semănătoarea se cuplează folosind bolțul și siguranța din dotare

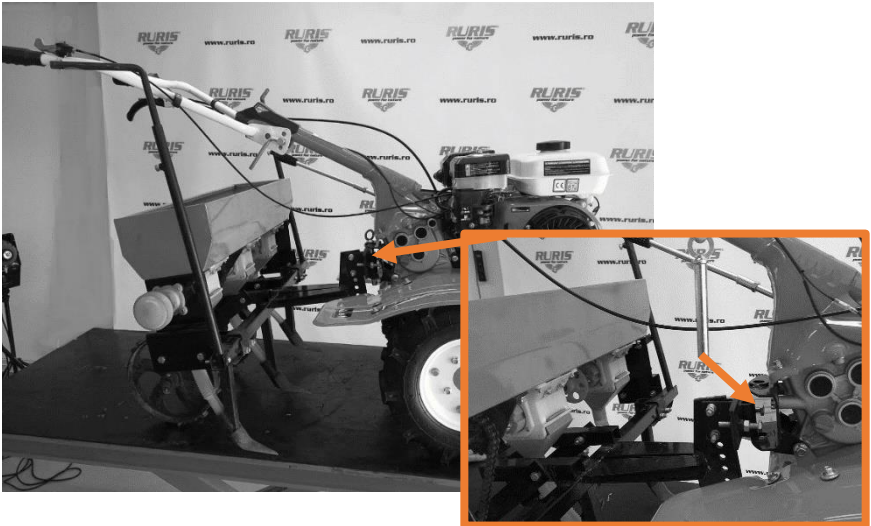



14.8 CUPLARE SEMĂNĂTOARE PRECIZIE ÎNALTA PTS2

1. Semănătoarea se cuplează folosind bolțul și siguranța din dotare

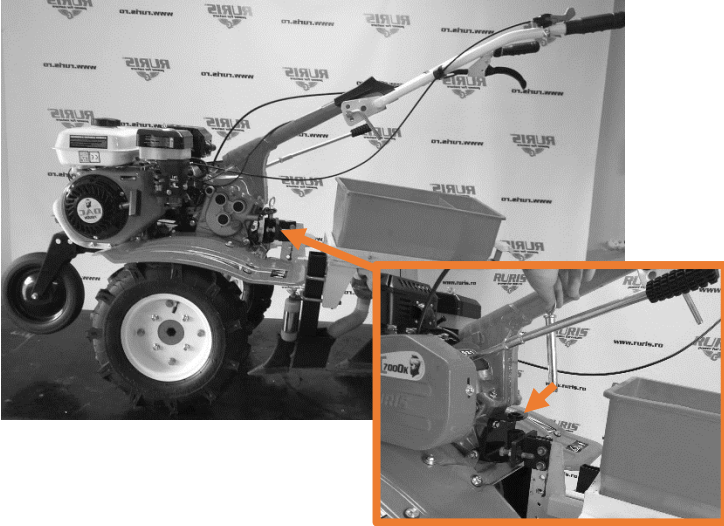



14.9 CUPLARE LAMA DE ZĂPADĂ

1. Lamă de zapadă se cuplează folosind șuruburile din dotare

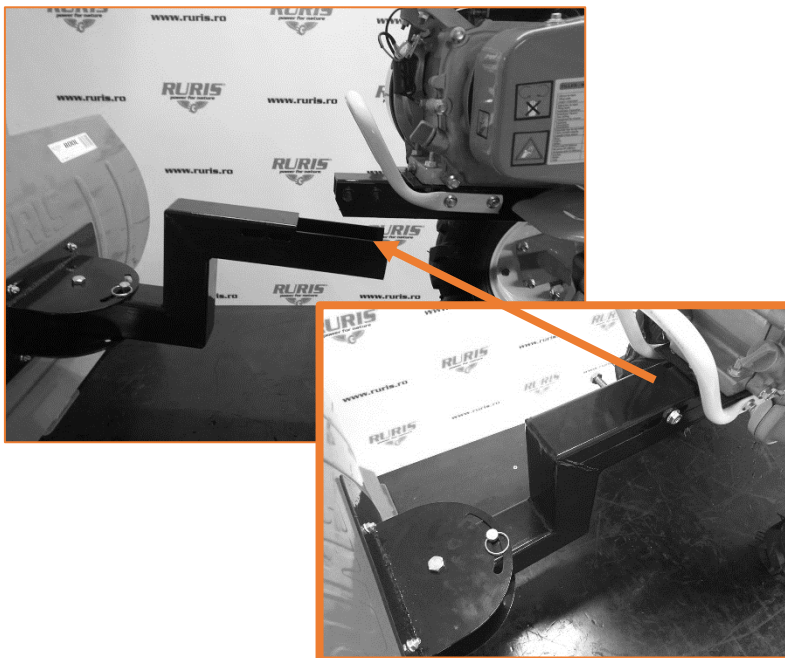



15. CUPLARE SUPORT REGLAJ ADÂNCIME SI PLUG DE ÎNGROPAT

1. Suportul de reglaj adâncime și plugul se cuplează folosind șuruburile din dotare





15.1 SISTEM DE COSIT CRT

1, Ghidul de montaj se află în cutia accesoriului





16. DECLARAȚII DE CONFORMITATE

DECLARATIA DE CONFORMITATE CE

Producator: SC RURIS IMPEX SRL

Calea Severinului, nr. 10, Bl. 317b, Craiova, Dolj, Romania

Tel. 0351 464 632, www.ruris.ro, info@ruris.ro

Reprezentant autorizat: ing. Stroe Marius Catalin – Director General

Persoana autorizata pentru dosarul tehnic: ing. Florea Nicolae – Director Proiectare Producție

Descrierea produsului: **MOTOSAPA** are rolul de prelucrare a solului si alte lucrari, motosăpătoarea fiind componenta energetică de baza, iar freza rotativa cu cutite si alte accesorii echipamentul de lucru efectiv.

Produsul: **MOTOSAPA**

Numar de serie produs: de la xx DAC6500K 0001 la xx DAC6500K 9999 (unde xx reprezinta ultimele doua cifre ale anului de fabricatie)

Tipul: 6500K

Model: DAC

Motor: termic, pe benzina fara plumb, 4 timpi

Putere: 7 CP

Nr. viteze: 2 inainte + 1 inapoi

Nr max de cutite: 24 (4x6) seturi

Transmisie: cu roti dintate/lant curele

Latime de lucru: max 83 cm

Noi, SC RURIS IMPEX SRL Craiova, producator, în conformitate cu H.G. 1029/2008 - privind condițiile introducerii pe piață a mașinilor, Directiva 2006/42/CE – masini; cerințe de siguranță și securitate, Standardul EN ISO 12100:2010 – Masini. Securitate, Regulamentul UE 2016/1628 (amendat prin Regulamentul UE 2018/989) - stabilirea masurilor de limitare a emisiilor gazeoase si de particule poluante provenite de la motoare si H.G. 467/2018 privind masurile de aplicare ale Regulamentului mentionat, am efectuat atestarea conformității produsului cu standardele specificate și declarăm că este conform cu principalele cerințe de siguranță și securitate.

Subsemnatul Stroe Catalin, reprezentantul producatorului, declar pe proprie raspundere ca produsul este in conformitate cu urmatoarele standarde si directive europene:

SR EN ISO 12100:2011/ EN ISO 12100:2010 - Securitatea mașinilor. Concepte de bază, principii generale de proiectare. Terminologie de bază, metodologie. Principii tehnice

SR EN ISO 3744:2011/ EN ISO 3744:2011 - Mașini forestiere și mașini pentru grădinarit. Cod de încercare acustică pentru mașinile echipate cu motor cu ardere internă.

SR EN ISO 11850:2012/ EN ISO 11850:2011- Mașini forestiere. Cerințe generale de Securitate

SR EN ISO 4254-1:2016/ EN ISO 4254-1:2015 - Mașini agricole. Securitate.

SR EN ISO 4254-5:2018/ EN ISO 4254-5:2018 - Mașini agricole. Securitate. Partea 5: Mașini de prelucrat solul cu organe de lucru acționate de motor

SR EN 709+A4:2010/AC:2013 Mașini agricole și forestiere. Motocultoare echipate cu freze purtate, motoprășitoare și freze pe roată(roți) motrică(e). Securitate

SR EN 14930+A1:2009/ EN ISO 14930:2007+A1:2009 - Mașini agricole și forestiere și mașini pentru grădinarit. Mașini ținute cu mâna și cu conductor pedestru. Determinarea riscului de contact cu suprafețele fierbinți



SR EN 12733:2019/ EN 12733:2018- Mașini agricole și forestiere. Motocositori cu operator pedestru. Securitate

SR EN 1679-1+A1:2011/ EN 1679-1:1998+A1:2011- Motoare cu ardere internă cu mișcare alternativă. Securitate. Partea 1: Motoare cu aprindere prin comprimare

SR EN 11850:2012/A1:2016/ EN ISO 11850:2011/A1:2016- Mașini forestiere. Mașini autopropulsate. Cerințe de securitate

EN 14982:2009 – Masini Agricole si forestiere. Compatibilitate electromagnetica.

SR EN 55014-1:2017; 55014-2:2015 – Compatibilitate electromagnetica

SR EN 61000-3-2/2014; 61000-3-3/2013 – Compatibilitate electromagnetica

- **Directiva 2000/14/CE** (amendata prin Directiva 2005/88/CE) – Emisiile de zgomot în mediul exterior
- **Directiva 2006/42/EC** - privind mașinile – introducerea pe piata a masinilor
- **Directiva 2014/30/UE** - privind compatibilitatea electromagnetica (HG 487/2016 privind compatibilitatea electromagnetica, actualizata 2019);
- **Regulamentul UE 2016/1628 (amendat prin Regulamentu UE 2018/989)** - stabilirea masurilor de limitare a emisiilor gazease si de particule poluante provenite de la motoare

Alte Standarde sau specificatii utilizate:

- **SR EN ISO 9001** - Sistemul de Management al Calitatii
- **SR EN ISO 14001** - Sistemul de Management al Mediului
- **SR ISO 45001:2018** - Sistemul de Management al Sanatatii si Securitatii Ocupationale.

MARCAREA SI ETICHETAREA MOTOARELOR

Motoarele pe benzina cu aprindere prin scanteie recepționate si utilizate pe echipamentele si masinile RURIS, conform **Regulamentul UE 2016/1628 (amendat prin Regulamentul UE 2018/989)** si a HG 467/2018 sunt marcate cu:

- Marca si numele producătorului: C.H.P.T. CO LTD.

- Tipul: H210

- Numărul aprobării de tip obtinut de producatorul specializat:

e13*2016/1628*2016/1628SRA2/P*0303*00;

- Numărul de identificare al motorului – numar unic.

- Concept General Engine

Nota: documentatia tehnica este detinuta de producator.

Precizare: Prezenta declaratie este conforma cu originalul.

Termen de valabilitate: 10 ani de la data aprobarii.

Locul si data emiterii: **Craiova, 25.06.2021**

Anul aplicarii marcajului CE: **2021**

Nr. inreg: **800/25.06.2021**

Persoana autorizata si semnatura:

Ing. Stroe Marius Catalin
Director General al
SC RURIS IMPEX SRL



DECLARATIA DE CONFORMITATE EC

Producator: SC RURIS IMPEX SRL

Calea Severinului, nr. 10, Bl. 317b, Craiova, Dolj, Romania

Tel. 0351 464 632, www.ruris.ro, info@ruris.ro

Reprezentant autorizat: ing. Stroe Marius Catalin – Director General

Persoana autorizata pentru dosarul tehnic: ing. Florea Nicolae – Director Proiectare Producție

Descrierea produsului: MOTOSAPA are rolul de prelucrare a solului si alte lucrari, motosăpătoarea fiind componenta energetică de baza, iar freza rotativa cu cutite si alte accesorii echipamentul de lucru efectiv

Numar de serie produs: de la xx DAC6500K 0001 la xx DAC6500K 9999 (unde xx reprezinta ultimele doua cifre ale anului de fabricatie)

Tipul: 6500K

Motor: termic, pe benzina fara plumb, 4 timpi

Nr. viteze: 2 inainte + 1 inapoi

Transmisie: cu roti dintate/lant curele

Model: DAC

Putere: 7 CP

Nr max de cutite: 24 (4x6) seturi

Latime de lucru: max 83 cm

Nivelul de putere acustica (relanti): 84 dB(A)

Nivelul de putere acustica: 84 dB(A)

Nivelul de putere acustica este certificat de I.N.M.A Bucuresti prin raportul de incercari nr. 2/05.09.2019 in conformitate cu prevederile Directivei 2000/14/CE amendata prin Directiva 2005/88/CE si SR EN ISO 3744:2011

Noi, SC RURIS IMPEX SRL Craiova in calitate de producator, in conformitate cu Directiva 2000/14/CE (amendata prin Directiva 2005/88/CE), H.G. 1756/2006 - privind limitarea nivelului emisiilor de zgomot în mediu produs de echipamente destinate utilizării în exteriorul clădirilor, am efectuat verificarea și atestarea conformității produsului cu standardele specificate și declarăm că este conform cu principalele cerințe.

Subsemnatul Stroe Catalin, reprezentantul producatorului, declar pe proprie raspundere ca produsul este in conformitate cu urmatoarele standarde si directive europene:

- **Directiva 2000/14/CE (amendata prin Directiva 2005/88/CE)** – Emisiile de zgomot in mediul exterior
- **SR EN ISO 3744:2011** - Acustică. Determinarea nivelurilor de putere acustică emise de sursele de zgomot utilizând presiunea acustică
- **Directiva 2006/42/EC** - privind mașinile – introducerea pe piata a masinilor
- **Directiva 2014/30/UE** privind compatibilitatea electromagnetica (HG 487/2016 privind compatibilitatea electromagnetica, actualizata 2019);
- **Regulamentul UE 2016/1628** (amendat prin Regulamentu UE 2018/989) - stabilirea masurilor de limitare a emisiilor gazoase si de particule poluante provenite de la motoare

Alte Standarde sau specificatii utilizate:

- **SR EN ISO 9001** - Sistemul de Management al Calitatii
- **SR EN ISO 14001** - Sistemul de Management al Mediului
- **SR ISO 45001:2018** - Sistemul de Management al Sanatatii si Securitatii Ocupationale.



Nota: documentatia tehnica este detinuta de producator.

Precizare: Prezenta declaratie este conforma cu originalul.

Termen de valabilitate: 10 ani de la data aprobarii.

Locul si data emiterii: **Craiova, 25.06.2021**

Anul aplicarii marcajului CE: **2021**

Nr. inreg: **801/25.06.2021**

Persoana autorizata si semnatura:

Ing. Stroe Marius Catalin
Director General al
SC RURIS IMPEX SRL

DECLARATIA DE CONFORMITATE CE

Producator: SC RURIS IMPEX SRL

Calea Severinului, nr. 10, Bl. 317b, Craiova, Dolj, Romania

Tel. 0351 464 632, www.ruris.ro, info@ruris.ro

Reprezentant autorizat: ing. Stroe Marius Catalin – Director General

Persoana autorizata pentru dosarul tehnic: ing. Florea Nicolae – Director Proiectare Producție

Descrierea produsului: **MOTOSAPA** are rolul de prelucrare a solului si alte lucrari, motosăpătoarea fiind componenta energetică de baza, iar freza rotativa cu cutite si alte accesorii echipamentul de lucru efectiv.

Produsul: **MOTOSAPA**

Numar de serie produs: de la xx DAC6500ACC 0001 la xx DAC6500ACC 9999 (unde xx reprezintă ultimele doua cifre ale anului de fabricatie)

Tipul: 6500ACC

Motor: termic, pe benzina fara plumb, 4 timpi

Nr. viteze: 2 inainte + 1 inapoi

Transmisie: cu roti dintate/lant curele

Model: DAC

Putere: 7 CP

Nr max de cutite: 24 (4x6) seturi

Latime de lucru: max 83 cm

Noi, SC RURIS IMPEX SRL Craiova, producator, în conformitate cu H.G. 1029/2008 - privind condițiile introducerii pe piață a mașinilor, **Directiva 2006/42/CE – masini; cerințe de siguranță și securitate**, Standardul EN ISO 12100:2010 – Masini. Securitate, **Regulamentul UE 2016/1628 (amendat prin Regulamentul UE 2018/989) - stabilirea masurilor de limitare a emisiilor gazoase si de particule poluante provenite de la motoare** si H.G. 467/2018 privind masurile de aplicare ale Regulamentului mentionat, am efectuat atestarea conformității produsului cu standardele specificate și declarăm că este conform cu principalele cerințe de siguranță și securitate.

Subsemnatul Stroe Catalin, reprezentantul producatorului, declar pe proprie raspundere ca produsul este in conformitate cu urmatoarele standarde si directive europene:



SR EN ISO 12100:2011/ EN ISO 12100:2010 - Securitatea mașinilor. Concepte de bază, principii generale de proiectare. Terminologie de bază, metodologie. Principii tehnice

SR EN ISO 3744:2011/ EN ISO 3744:2011 - Mașini forestiere și mașini pentru grădinărit. Cod de încercare acustică pentru mașinile echipate cu motor cu ardere internă.

SR EN ISO 11850:2012/ EN ISO 11850:2011- Mașini forestiere. Cerințe generale de Securitate

SR EN ISO 4254-1:2016/ EN ISO 4254-1:2015 - Mașini agricole. Securitate.

SR EN ISO 4254-5:2018/ EN ISO 4254-5:2018 - Mașini agricole. Securitate. Partea 5: Mașini de prelucrat solul cu organe de lucru acționate de motor

SR EN 709+A4:2010/AC:2013 Mașini agricole și forestiere. Motoculatoare echipate cu freze purtate, motoprășitoare și freze pe roată(roți) motrică(e). Securitate

SR EN 14930+A1:2009/ EN ISO 14930:2007+A1:2009 - Mașini agricole și forestiere și mașini pentru grădinărit. Mașini ținute cu mâna și cu conductor pedestru. Determinarea riscului de contact cu suprafețele fierbinți

SR EN 12733:2019/ EN 12733:2018- Mașini agricole și forestiere. Motocositori cu operator pedestru. Securitate

SR EN 1679-1+A1:2011/ EN 1679-1:1998+A1:2011- Motoare cu ardere internă cu mișcare alternativă. Securitate. Partea 1: Motoare cu aprindere prin comprimare

SR EN 11850:2012/A1:2016/ EN ISO 11850:2011/A1:2016- Mașini forestiere. Mașini autopropulsate. Cerințe de securitate

EN 14982:2009 – Masini Agricole si forestiere. Compatibilitate electromagnetica.

SR EN 55014-1:2017; 55014-2:2015 – Compatibilitate electromagnetica

SR EN 61000-3-2/2014; 61000-3-3/2013 – Compatibilitate electromagnetica

- **Directiva 2000/14/CE** (amendata prin Directiva 2005/88/CE) – Emisiile de zgomot în mediul exterior
- **Directiva 2006/42/EC** - privind mașinile – introducerea pe piata a masinilor
- **Directiva 2014/30/UE** - privind compatibilitatea electromagnetica (HG 487/2016 privind compatibilitatea electromagnetica, actualizata 2019);
- **Regulamentul UE 2016/1628 (amendat prin Regulamentu UE 2018/989)** - stabilirea masurilor de limitare a emisiilor gazoase si de particule poluante provenite de la motoare

Alte Standarde sau specificatii utilizate:

- **SR EN ISO 9001** - Sistemul de Management al Calitatii
- **SR EN ISO 14001** - Sistemul de Management al Mediului
- **SR ISO 45001:2018** - Sistemul de Management al Sanatatii si Securitatii Ocupationale.

MARCAREA SI ETICHETAREA MOTOARELOR

Motoarele pe benzina cu aprindere prin scanteile recepționate si utilizate pe echipamentele si masinile RURIS, conform **Regulamentul UE 2016/1628 (amendat prin Regulamentul UE 2018/989)** si a HG 467/2018 sunt marcate cu:

- Marca si numele producătorului: C.H.P.T. CO LTD.

- Tipul: H210

- Numărul aprobării de tip obținut de producatorul specializat:

e13*2016/1628*2016/1628SRA2/P*0303*00;

- Numărul de identificare al motorului – numar unic.



- Concept General Engine

Nota: documentatia tehnica este detinuta de producator.

Precizare: Prezenta declaratie este conforma cu originalul.

Termen de valabilitate: 10 ani de la data aprobarii.

Locul si data emiterii: **Craiova, 25.06.2021**

Anul aplicarii marcajului CE: **2021**

Nr. inreg: **798/25.06.2021**

Persoana autorizata si semnatura:

Ing. Stroe Marius Catalin
Director General al
SC RURIS IMPEX SRL

DECLARATIA DE CONFORMITATE **EC**

Producator: SC RURIS IMPEX SRL

Calea Severinului, nr. 10, Bl. 317b, Craiova, Dolj, Romania

Tel. 0351 464 632, www.ruris.ro, info@ruris.ro

Reprezentant autorizat: ing. Stroe Marius Catalin – Director General

Persoana autorizata pentru dosarul tehnic: ing. Florea Nicolae – Director Proiectare Producție

Descrierea produsului: **MOTOSAPA** are rolul de prelucrare a solului si alte lucrari, motosăpătoarea fiind componenta energetică de baza, iar freza rotativa cu cutite si alte accesorii echipamentul de lucru efectiv

Numar de serie produs: de la xx DAC6500ACC 0001 la xx DAC6500ACC 9999 (unde xx reprezinta ultimele doua cifre ale anului de fabricatie)

Tipul: 6500ACC

Motor: termic, pe benzina fara plumb, 4 timpi

Nr. viteze: 2 inainte + 1 inapoi

Transmisie: cu roti dintate/lant curele

Model: DAC

Putere: 7 CP

Nr max de cutite: 24 (4x6) seturi

Latime de lucru: max 83 cm

Nivelul de putere acustica (relanti): **84 dB(A)**

Nivelul de putere acustica: **84 dB(A)**

Nivelul de putere acustica este certificat de I.N.M.A Bucuresti prin raportul de incercari nr. 2/05.09.2019 in conformitate cu prevederile Directivei 2000/14/CE amendata prin Directiva 2005/88/CE si SR EN ISO 3744:2011

Noi, SC RURIS IMPEX SRL Craiova in calitate de producator, in conformitate cu Directiva 2000/14/CE (amendata prin Directiva 2005/88/CE), H.G. 1756/2006 - privind limitarea nivelului emisiilor de zgomot in mediu produs de echipamente destinate utilizării în exteriorul clădirilor, am efectuat verificarea și atestarea conformității produsului cu standardele specificate și declarăm că este conform cu principalele cerințe.



Subsemnatul Stroe Catalin, reprezentantul producatorului, declar pe proprie raspundere ca produsul este in conformitate cu urmatoarele standarde si directive europene:

- **Directiva 2000/14/CE (amendata prin Directiva 2005/88/CE)** – Emisiile de zgomot in mediul exterior
- **SR EN ISO 3744:2011** - Acustică. Determinarea nivelurilor de putere acustică emise de sursele de zgomot utilizând presiunea acustică
- **Directiva 2006/42/EC** - privind mașinile – introducerea pe piata a masinilor
- **Directiva 2014/30/UE** privind compatibilitatea electromagnetica (HG 487/2016 privind compatibilitatea electromagnetica, actualizata 2019);
- **Regulamentul UE 2016/1628** (amendat prin Regulamentu UE 2018/989) - stabilirea masurilor de limitare a emisiilor gazoase si de particule poluante provenite de la motoare

Alte Standarde sau specificatii utilizate:

- **SR EN ISO 9001** - Sistemul de Management al Calitatii
- **SR EN ISO 14001** - Sistemul de Management al Mediului
- **SR ISO 45001:2018** - Sistemul de Management al Sanatatii si Securitatii Ocupationale.

Nota: documentatia tehnica este detinuta de producator.

Precizare: Prezenta declaratie este conforma cu originalul.

Termen de valabilitate: 10 ani de la data aprobarii.

Locul si data emiterii: **Craiova, 25.06.2021**

Anul aplicarii marcajului CE: **2021**

Nr. inreg: **799/25.06.2021**

Persoana autorizata si semnatura:

Ing. Stroe Marius Catalin
Director General al
SC RURIS IMPEX SRL



Eredeti használati utasítás
DAC 6500K / DAC 6500ACC
Motoros Kapagép

Előszó

A DAC márkájú motoros kapák olyan lánc-kapcsolásos kapagépek, melyeket könnyű karbantartani, és melyek könnyedén használhatóak az Ön számára.

A DAC kapagépek könnyű, megművelt földön történő használata javasolt.

A láncos kapagépek különösen a könnyen feldolgozható, homokos talajokra vannak optimalizálva.

Ha keményebb talajt szeretne feldolgozni, kérjük keresse termék skálánkat valamelyik hivatalos Ruris márkaképviselőben.

Köszönjük, hogy a DAC terméket választotta!

Információ és ügyfélszolgálat:

Telefon: **0351 820 105**

E-mail: **info@ruris.ro**



Munkavédelem

Figyelmeztetések



Figyelem! Veszély!



Olvassa végig a használati útmutatót ezen gépek használata előtt.



A gépkezelő viseljen személyi munkavédelmi felszerelést. A gép működtetésekor viseljünk védőszemüveget a gép által felrepített tárgyak ellen, viseljünk hallásvédelmi felszerelést, mint a hangszigetelt fülvédőt és védősisakot.



Viseljünk kézvédő felszerelést (kesztyűt).



Viseljünk lábvédő felszerelést (csizma, bakancs).



Veszély: Veszélyes elemeket dobhat fel a kés, működés közben.



Tartsuk távol a nyílt lángot. Ne dohányozzunk. Ne öntsünk ki üzemanyagot. Ne tankoljunk amikor a motor működik vagy fel van forrósodva.



A kapagépek összetevői

A kapagépek a következő alkatrészekből tevődnek össze:

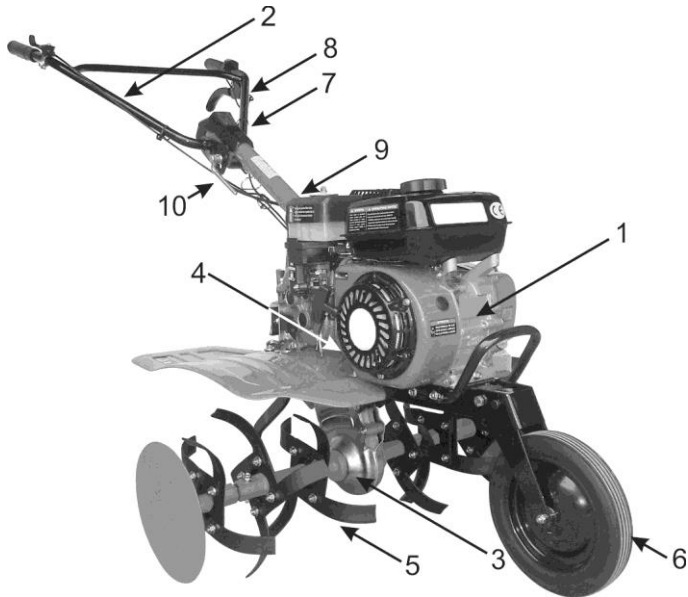

Fig. 2

1. motor
2. kormányszarv
3. kapcsolószekrény ház
4. indítószervezet
5. vágókécek
6. szállítókerék
7. magasság szabályozó támasz
8. kuplungkábel
9. kormányszarv támasz
10. gázkábel



Technikai leírások

- **Figyelmeztetés:**
- A DAC 6500K / DAC 6500 ACC kapagépeket nem töltjük fel gyárilag olajjalés üzemanyaggal. A működtetés előtt, ellenőrizze és töltsse fel az olajat, a szabályzatban előírt módon.
- A motortérben van a minimum olajsínt alatti olaj, de ez csak az eszköz biztonsága érdekében van, nem annak használatáért. Töltsse fel olajjal a rendszert!

Típus:	DAC 6500K / DAC 6500 ACC
Súly (késekkel)	80 kg
Motor	4 ütemű
Motorgyártó	General Engine
Hengerűrtartalom	208 cmc
Teljesítmény	7 LE/5.2 kW
Fordulat	Max. 3600 Min. 2000
Fogyasztás/h	250 ml/kwh
Üzemanyag	Ólommentes benzín

Használja a gépet arra a célra, amire rendeltetett, és pedíg földmégmunkálásra. Minden egyéb jellegű használat veszélyes lehet és károsíthatja az eszközt. Soha ne alkalmazza olyan területeken, melyek sziklásak, köveket tartalmazhatnak, kábelek futhatnak a földben vagy túl kemények a megmunkálásra..

Olajcsere a motorban, annak minden 25-ik óra működése után.

A sebességváltóban minden 50 óra működés után.

Bejáratási időszak

1. A DAC 6500K / DAC 6500 kapológép könnyű terhelés alatt csak 5 órát működhet, majd ürítsük ki a kenőanyagot a tartályból és a kapcsolószekrényből. Azután töltsük fel a kapcsolószekrényt Ruris G Tronic márkájú, vagy egy API osztályzatú GL-4 vagy ennél felsőbb osztályú olajjal, a motort pedig Ruris 4T MAX márkájú, vagy egy API osztályzatú CI-4/SL vagy ennél felsőbb osztályú olajjal.

A DAC 6500K / DAC 6500 ACC kapagép ólommentes benzinnel működik.

2. Ajánlott használat előtt a gázolajat ülepedni hagyni és utána átszűrni egy fémszítán.



Összeszerelés

Az összeszerelés és működtetés előtt meg kell győződni arról, hogy a DAC 6500K / DAC 6500 ACC motoros kapa megfelelően van összeállítva és tiszteletben kell tartani ebben a kézikönyvben meghatározott szabályokat, csak ekkor nyílik lehetőség önálló működtetésre.

A motor olajsztintjének feltöltése

A motor indítása előtt, töltsön a motorba Ruris- 4t Max vagy magasabb osztályú API: CI-4/SL olajat.

A motoros kapa nem tartalmaz olajat az értékesítés pillanatában.

A motor olajkapacitása: 0,6L

FIGYELMEZTETÉS:

Ne használja kapálás funkcióban-, hátramenetben a gépet több mint 10 méteren.

Ellenőrizze gyakran az olajsztintet, a motoron található olajsapka lecsavarásával és győződjön meg róla, hogy az olaj eléri-e a megfelelő szintet a jelölés szerint. Ezt az ellenőrzést ajánlott mindig a kapagép vízszintes pozíciójában elvégezni.



2. Ábra

FIGYELMEZTETÉS:

Minden indítás előtt, négyszer lassan és finoman húzzuk ki az indítókábelt, (a bekapcsoló gomb OFF-on legyen) hogy a motorban az olaj elérjen minden hengert és szelepet.

Ellenkező esetben, a motor durva indításával kockáztatja a hengerek besülését és az eszköz meghibásodását.

1. Üzemanyaggal történő tankolás

Használjon minőségi üzemanyagot, hivatalos üzemanyag-töltőállomásról.

Tankoljon Ólommentes Benzint a legjobb minőségűből, fémtölcsér segítségével, és ezt végezze jól szellőző területen, távol minden tűz vagy szikra esetleges forrásától, mely akár balesetet okozhat.

FIGYELMEZTETÉS:

Ne tankoljon termőföld felett vagy növényzet közelében, mert súlyosan szennyezheti a környezetet.



A váltó, olajjal való feltöltése

A kapcsolószekrény olaj kapacitása 1500 ml.

Használjon Ruris G-Tronic, vagy annál magasabb osztályzatú API: GL-4 olajat.

A hajtómű maximális olajsintje a betápláló nyílás alján található

a hajtómű jobb oldalán (3.1-Ábra)

A kapagép olaj nélkül érkezik.

A kapcsolószekrényben történő olajcsere meg kell történnjen minden 50 munkaóra után.



3.1 Ábra



3.2 Ábra

Nível maxim: Maximum szint
Buson golire: olaj kiűrtési nyílás

ÜZEMBEHELYEZÉS

Tilos a motort üresjáratban üzemeltetni több mint 5 percig, mert károsíthatja a sebességváltó szíjat.

Az ön kapagépének motorja már gyárilag be van járva, nem igényel további bejáratást.

Mielőtt üzembe helyezi a DAC 6500K / DAC 6500 ACC típusú kapagépet, győződjön meg róla, hogy a következő feltételek biztosítva vannak:

- Töltse meg a levegőszűrőn található olajtartályt tiszta motorolajjal, a maximum megjelölésig;
- A kapagép öt méteres közelségében nincs más személy, aki nekiütközhet
- A DAC 6500K / DAC 6500 ACC kapagép vízszintesen helyezkedik;
- Az első kerék fel van szerelve és kimagaslik a földből
- A motor teljesen fel van töltve olajjal.
- A kapcsolószekrény teljesen fel van töltve olajjal.
- A motorban legalább fél liter üzemanyag van;
- A vágókések rögzítő csavarokkal vannak rögzítve, és ha a szállító kerekek is fel vannak szerelve, rögzíteni kell a rögzítő csavarokkal és a gumiabroncs nyomásának 1,5-2 bárnak kell lennie. Minden csavart kellőképpen meg kell húzni.



A motor indítása

- Kapcsolja be a motor sokk- karját,

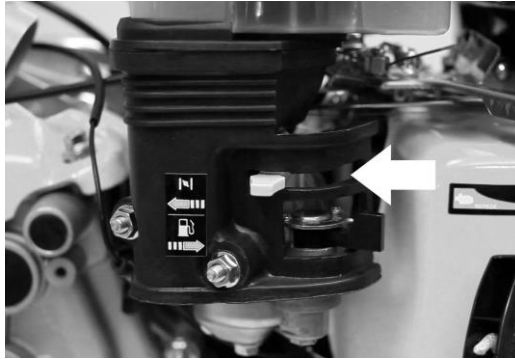

4. Ábra

Kapcsolja be a benzinszelep karját, a rajzon jelölt irányba

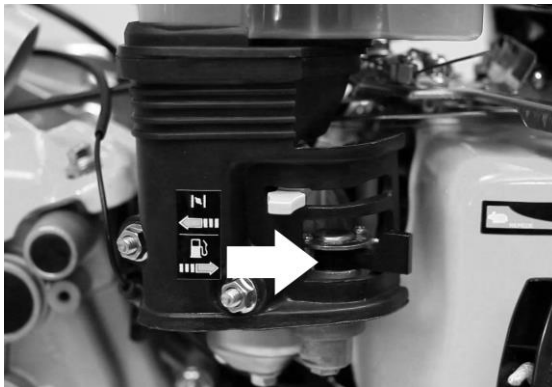

5. ábra:

- Húzza négyszer finoman meg az indítókábelt, de ne durván. Ez a finom mozdulat segíti a motorolaj szétterjedését a motor alkatrészeiben, szelepeiben, stb.
- Húzza maximumra a gázkart, akár csak a 6. ábrán
- Kapcsolja a ki-be kapcsoló gombot indításra.



6- Ábra

- Miután elvégezte a lassú, finom négyszeri berántást, most már erőteljesen is elkezdheti rántani az indítókötelet.
- A motor elindulásának pillanatától, kezdje lassan alaphelyzetbe állítani a sokk kart, vigyázva arra, hogy a motor ne álljon le, valamint csak akkor, ha a motor már simán jár.
- Csökkentse a motor túraszámát felére, majd a bal kezével lassan indíthatja a kapálás funkciót annak a karjának a működtetésével, és a kapakések elkezdnek forogni.

FIGYELMEZTETÉS:

Ha hirtelen elengedi a forgókések indítókarát, a hirtelen mozdulat azok leállítását okozza. Ha folyamatos kapcsolódási zaj hallható a tengelykapcsolóból, vagy ha a kapa nem mozdul el, akkor ellenőrizze a vágókések meghajtó kábelét, mert túl rövidre lett az beállítva.

MEGJEGYZÉS:

A tengelykapcsolást mindig a maximális fordulatszámon kell elvégezni, ellenkező esetben a szíj meghibásodását érhetjük el.

Ebben a helyzetben már készen áll megkezdeni a föld megművelését.

Szükséges műveletek, ha DAC 6500K / DAC 6500 ACC motoros kapagépünk nem indul:

- Ellenőrizze, hogy a motorolaj megfelelő szinten van-e, mert az a motorszerkezet amely forgatja az ön kapagépének a késeit egy olajfigyelő biztonsági szenzorral lehet ellátva, amely megszakítja a szikragyújtást a gyújtógyertya dugóján, ha nincs a motor maximális értéken;
- Ellenőrizze, hogy az üzemanyagszelep nyitó kar megfelelően el van fordítva;
- Ellenőrizze, hogy van e üzemanyag a tartályban és az megfelelő típusú-e. Ne használjon másféle üzemanyagot, mint ami az előírt, vagy olyant ami régebbi, mint 2-3 hét.



- Ellenőrizze, hogy a gázkar maximumra van-e fordítva;
- Ellenőrizze, hogy a sokk-kar már elzáródott, vissza az alap pozíciójába.
- Ellenőrizze, hogy a levegőszűrő nem e szennyeződött túl, nincs e eltömődve szennyeződésekkel;
- Cseréljen gyertyát.

KARBANTARTÁS

- Minden használat után tisztítsa meg a levegőszűrőt, és cseréljen olajat az olajtartályában, egy tiszta olajat alkalmazva, utóbbit minden 10. órában.

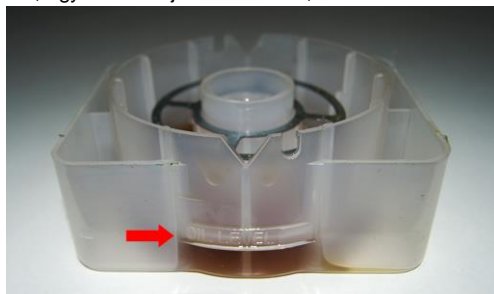

- Minden használat után tisztítsa le a forgókéseket és ellenőrizze
- Minden használat után zsírozza be az orsót, amelyen a vágókések vannak rögzítve
- Minden 60 perc használat után állítsa le a motort és hagyja azt pihenni legalább 20 percet.
- Állítson a sodronykábeleken, ha azt észleli, hogy a forgókések nem reagálnak megfelelően az irányításra, vagy indokolatlanul megállnak munka közben.
- Cseréljen motor és váltó olajat minden 50/25 munkaóra után, vagy ennek hiányában 6 havonta.

Az erőátviteli szíj beszerelése és leszerelése

Ez a következőképpen történik:

- A védőtok oldallapjának eltávolítása
- A szíj hatékony eltávolítása
- Az új szíj rácsatolása
- A védőtok oldallapjának

Ha kioldja a szíj szorítását, az új szíj beszerelésénél ügyeljen arra, hogy ugyan abba a pozícióba helyezze vissza a szíjt, forgassa meg 180 fokban, hogy meggyőződjön ugyanabban a szögben forog-e. Ezzel megkíméli a szíjat a sérülésektől.

Megjegyzés:

A csigát (bemart csigas kerék, melyben a szíj szalad) csak hivatalos márkaszervizben cserélhetik, mert egyedi maratokkal és méretekkel rendelkeznek. Ellenkező esetben tönkremegy a váltó szíj.

Ha egy hosszú munkamenet után a feszítő nem működik teljesen, a heveder csúszik, a hajtókábel újabb beállításra szükségeltetik.



HELYVÁLTOZTATÁS

Ha szállítani szeretné a DAC 6500K / DAC 6500 ACC kapagépeket egészen rövidtávon, Mindig legyen felszerelve a szállítókerék, ezzel is elkerülve a kapagép megsérülését.

Ne vontassa a kapagépet vagy azzal ne vontasson más járműveket, mert tönkretelheti a szerkezetet.

Egy kényelmes kezelés és vezetés érdekében állíthatja a kormányoszlop magasságát..

Csomagolás

A kapagép csomagolása zárt kartonborításban történik, a könnyebb szállíthatóság érdekében.

Ennek a tartalma:

- Használati utasítás
- Jótállási bizonylat
- DAC 6500K / 6500 ACC motoros kapa
- Szerszámcsomag

Tárolás

- A DAC 6500K / 6500 ACC motoros kapagép tárolása száraz, fedett, nedvességtől mentes helyiségben kell történnjen, ázás biztos fedél alatt, ablakokkal és megfelelő szellőzéssel ellátott helyiségben.
- Ürítse ki teljesen az üzemanyagot a tartályból és a karburátorból. .
- Zsírozza be az aktív fémrészeket
- Hagyja az olajat az olajtartályban a tárolás alatt.
- Ha 3 hónap tárolás után újra használja a kapagépet, cseréljen újra olajat benne.

MOTOBINEUSE RURIS

**DAC 6000K - 6500K - 7000K
7009 - 7088 - 7099**

Manuel opérateur

sur youtube: video du montage à suivre:

pour 7088 :

<https://www.youtube.com/watch?v=bsTJWBC0Mnk>

pour 7009 :

<https://www.youtube.com/watch?v=jlo6Dbb1bNA>

Table

1. Instructions Sécurité.....	4
2. Utilisation normale.....	8
3. Pré-Opération	8
4. Démarrage moteur	11
5. Travail motobineuse.....	13
6. Entretien	18
7. Transport /stockage	24

 **WARNING**

Risque de danger provoquant des blessures graves ou mortelles

 **CAUTION**

Possibilité de dommages ou blessures si non respect des règles

NOTE: aide.

 **WARNING**

Lire ce manuel avant l'utilisation de la motobineuse

Les illustrations peuvent varier selon les types de machine.

1 . SECURITE INSTRUCTIONS :



RESPONSABILITE de l'opérateur :

- Gardez le motoculteur en bon état de fonctionnement.
- Assurez-vous que tous les dispositifs de sécurité sont en état de marche et que les étiquettes d'avertissement sont en place.
- Soyez sûr que les protections de sécurité (protection ventilateur, du lanceur) sont en place.
- Savoir comment arrêter le moteur et les fraises rapidement en cas d'urgence.
Comprendre l'utilisation de tous les contrôles.
- Gardez une prise ferme sur le guidon, il peut avoir tendance à se soulever lors de l'engagement de l'embrayage.

WARNING

- Ne permettez à personne de faire fonctionner ce motoculteur sans une formation adéquate pour éviter les blessures.
- Port de chaussures solides. Ne pas utiliser pieds nus ou avec des chaussures à bout ouvert ou des sandales pour éviter les risques de blessure.
- Habits de travail. Des vêtements amples peuvent être saisis par des pièces en mouvement, ce qui augmente le risque de blessure.
- Être attentif. Ne pas utiliser quand vous êtes fatigué, malade ou sous l'influence de l'alcool ou de drogues, risque d'entraîner des blessures graves.
- Tenez toutes les personnes et les animaux éloignés de la zone de travail du sol.
- Assurez-vous que la jauge de profondeur est en place et correctement ajustée.

Sécurité Enfants :

- Maintenez les enfants à l'extérieur de la zone de travail et du motoculteur.
- Ne supposez jamais que les enfants vont rester là où ils ont été vus. Soyez vigilant et arrêtez le motoculteur si des enfants pénètrent dans la zone.
- Les enfants ne devraient jamais être autorisés à utiliser le motoculteur, même sous surveillance d'un adulte.

Projection d'objet : danger

- Les objets touchés par les fraises en rotation peuvent être projetés à partir du motoculteur avec une grande force et peuvent causer des blessures graves.
- Avant de labourer nettoyer clairement la zone de labourage des bâtons, du verre, du fil et pierres, etc.
- Travailler seulement dans la lumière du jour.
- Pièces usées ou endommagées peuvent causer des blessures graves. Toujours inspecter les fraises avant d'utiliser la machine.



Incendie et brûlure

L'essence est extrêmement inflammable et les vapeurs d'essence peuvent exploser.

*Prenez un soin extrême lors de la manipulation de l'essence. Gardez l'essence hors de portée des enfants.

*Faire le plein dans un endroit bien aéré avec le moteur arrêté.

*Laisser le moteur refroidir avant de faire le plein. Les vapeurs de carburant ou le carburant peuvent s'enflammer.

*Le système de moteur et l'échappement deviennent très chauds pendant le fonctionnement et restent chauds pendant un certain temps après l'arrêt. Le contact avec les pièces chaudes du moteur peut causer des brûlures et peut enflammer certains matériaux.

*Laisser le moteur refroidir avant d'effectuer l'entretien ou le stockage du motoculteur à l'intérieur.

Le monoxyde de carbone: Risque d'empoisonnement

Échappement contient du monoxyde de carbone qui est un gaz incolore et inodore. Les gaz d'échappement peuvent provoquer une perte de conscience et conduire à la mort.

Si vous démarrez le moteur dans un endroit qui est confiné ou même partiellement clos, l'air que vous respirez pourrait contenir une quantité dangereuse de gaz d'échappement. Fournir une ventilation adéquate.

Fonctionnement en pente

*Lorsque vous labourez sur des pentes, garder le réservoir moins de la moitié de carburant pour minimiser les fuites

*fraisage à travers de la pente (A intervalles équidistants) plutôt que monter et descendre.

*Soyez très prudent lorsque vous modifiez la direction du motoculteur sur une pente.

*Ne pas l'utiliser sur une pente de plus de 10 °

*L'angle maximal de qualité en toute sécurité est montré à des fins de référence seulement et doit être déterminé en fonction du type de l'outil. Pour votre sécurité et la sécurité d'autrui.

Faites très attention lorsque vous utilisez le motoculteur vers le haut ou bas de la colline.

AUTOCOLLANT SECURITE

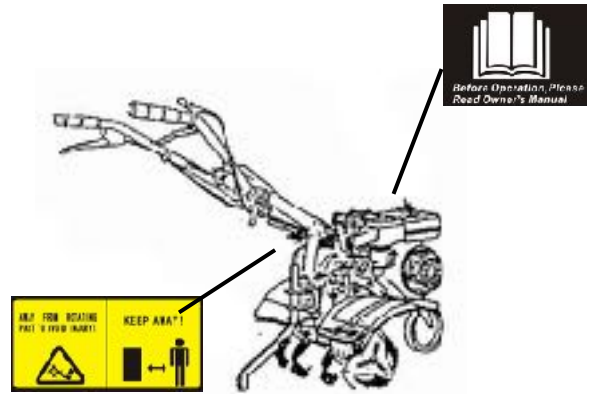
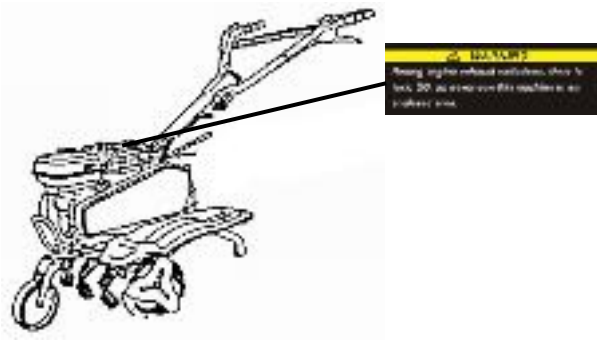

2. UTILISATION NORMALE :

Les motobineuses Ruris DAC sont appropriées pour cultiver un sol sableux et de terre argileuse pour une base de légumes et de terre ferme. Les sols avec des pentes de moins de 10%.

Pour parcelles herbeuses et profondes, enlever les mauvaises herbes avant d'utiliser le motoculteur.

3. PRE-OPERATION CONTROLE :

1. Huile Moteur :

Attention : Démarrer un moteur avec un niveau d'huile trop bas peut sérieusement endommager le moteur.

Enlever la jauge et la nettoyer.

1. Insérer la jauge dans le conduit et la poser (ne pas visser)
2. Si le niveau est inférieur au bout de la jauge: en rajouter
3. La capacité d'huile est de 600 ml

Utiliser une huile de qualité 4 temps certifiée API SG ou SF

Attention: ne pas utiliser une huile 2 temps car la durée de vie du moteur serait très courte.

Une huile multigrade SAE30 ou 15W-40 est recommandée, elle convient aux températures extérieures habituelles d'utilisation . Pour une autre viscosité, il faut vous référer au tableau ci-dessous.

- (1) trou pour huile
- (2) niveau haut
- (3) niveau bas

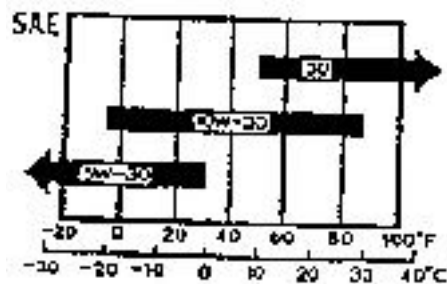

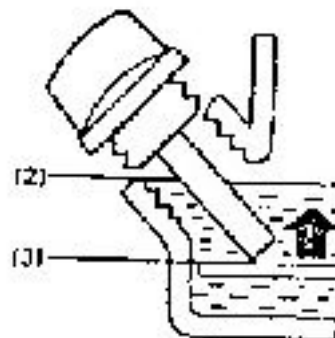

2. Huile de transmission :

Placez la machine sur une surface plane et retirez le bouchon de remplissage d'huile.

L'huile doit être de niveau avec le bord inférieur de l'orifice de remplissage d'huile. La capacité est de 1500 ml avec une huile de qualité type G.Tronic ou EP80-90.

(1) trou remplissage huile

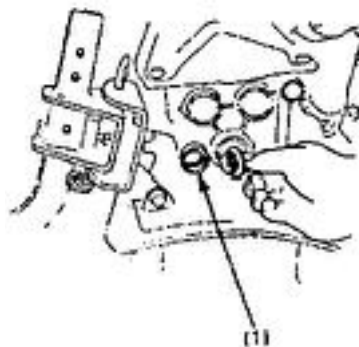

3. Filtre à air :

Contrôler et nettoyer des débris

(1) ELEMENTS



4. Essence :

Utiliser de l'essence sans plomb 95 E10 maximum.

Toujours de l'essence fraîche, si vous désirez la stocker plus d'un mois: rajouter un conservateur

Ne jamais utiliser un mélange huile/essence .ou de l'essence périmée. Contrôler les saletés et l'eau (condensats) à l'intérieur du réservoir

Attention: Ne pas remplir au dessus de la ligne rouge

 **WARNING**

- L'essence est extrêmement inflammable et explosive dans certaines conditions.
- Faire le plein dans un endroit bien aéré avec le moteur arrêté. Ne pas fumer ou de flammes ou d'étincelles dans la zone où le moteur est ravitaillé et où l'essence est stockée.
- Ne pas trop remplir le réservoir de carburant (il devrait y avoir aucun carburant dans le goulot de remplissage). Après le ravitaillement, assurez-vous que le bouchon du réservoir est correctement et solidement fermé.
- Veillez à ne pas renverser de carburant en faisant le plein. Vapeurs de carburant ou le carburant peut s'enflammer. Si du carburant est renversé, assurez-vous que la zone est sèche avant de démarrer le moteur.
- Éviter tout contact répété ou prolongé avec la peau ou en respirant les vapeurs.
- Capacité du réservoir de carburant: 3.0L ou 3.6L

(1) ligne rouge

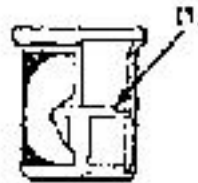
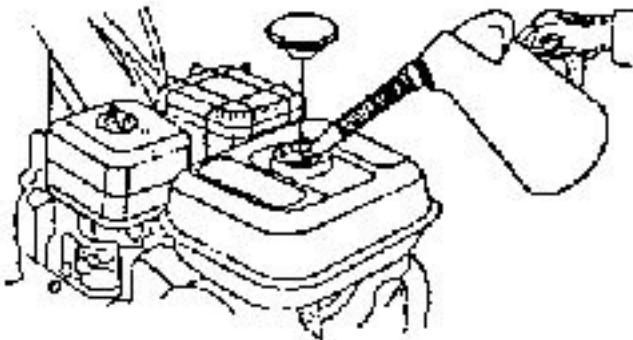

4. DEMARRAGE MOTEUR

Attention: Soyez sûr que l'embrayage est désengagé et le levier de vitesses est en position neutre pour éviter tout mouvement soudain et incontrôlé lorsque le moteur démarre. L'embrayage est engagé en tirant le levier d'embrayage et désengagé en relâchant le levier.

1. Tourner l'arrivée d'essence sur ON. Contrôler que le bouchon de cuve carburateur est étanche.

(1) arrivée essence

(2) ouvert

(3) vis cuve

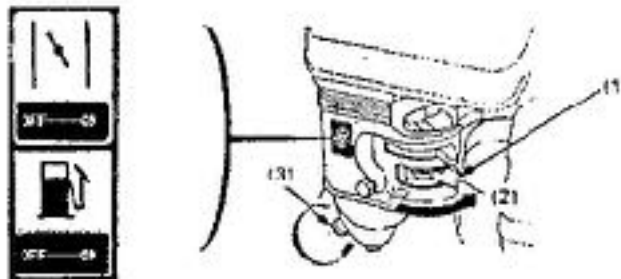

2. Fermer le starter.

NOTE: Ne pas utiliser le starter si le moteur est chaud ou si la température extérieure est chaude. Toutefois une action rapide est nécessaire pour relancer le moteur.

(1) levier Starter

(2) Fermer

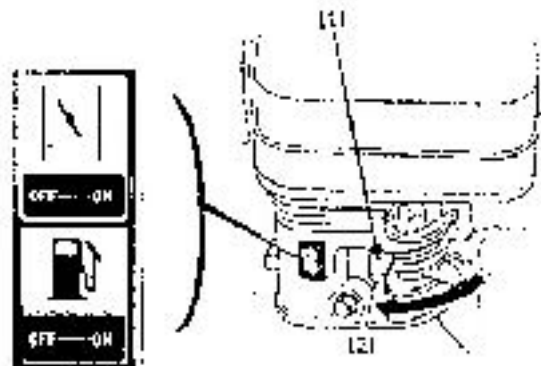

3. Mettre l'interrupteur sur ON

(1) ON

(2) Interrupteur

4. Déplacez la manette des
(1) Manette gaz

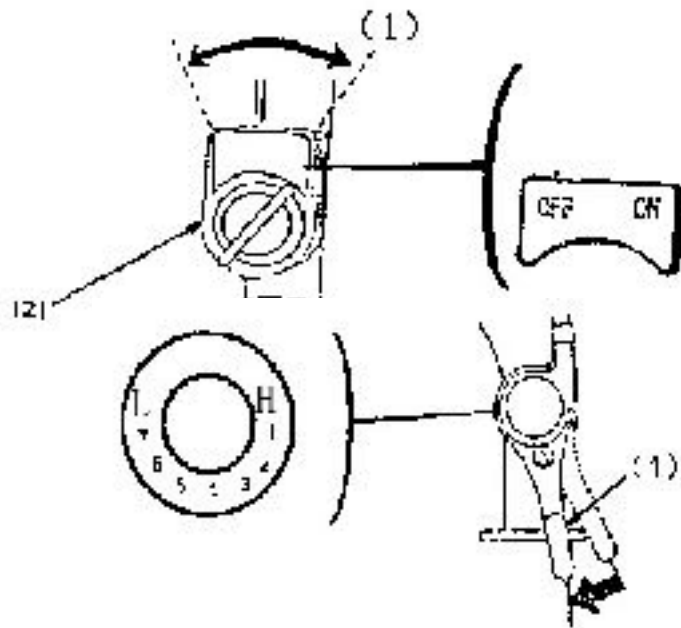

5. Tirez légèrement la poignée du démarreur jusqu'à sentir une résistance puis tirer vigoureusement.
ATTENTION: Ne pas laisser la poignée du démarreur revenir brusquement contre le moteur. Retourner délicatement pour éviter d'endommager le démarreur.
1 poignée

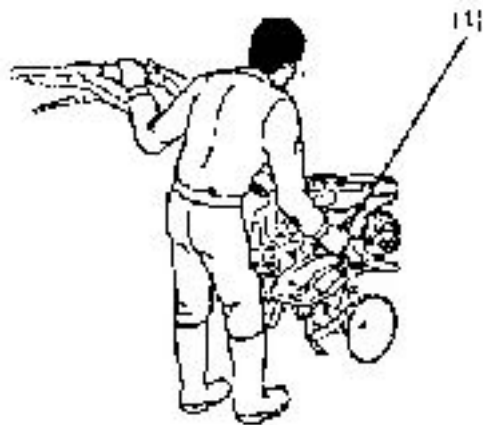

6. Quand le moteur chauffe, ouvrir graduellement le starter
Lever starter

(1) OPEN

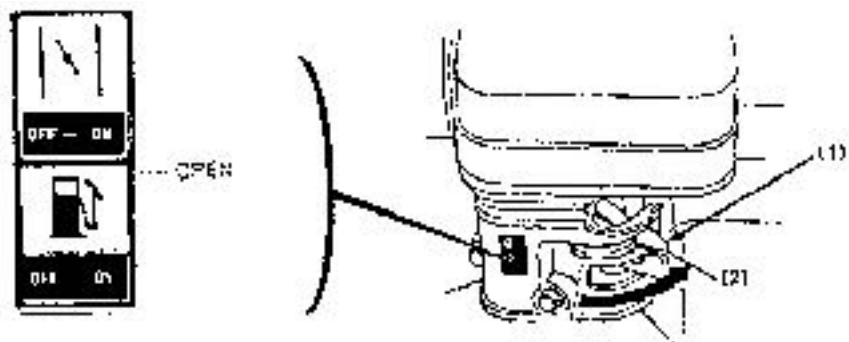

5. TRAVAIL MOTOBINEUSE :

1. Ajustement du guidon

Attention: Avant de régler le guidon, mettre le motoculteur sur un sol ferme pour empêcher la poignée de tomber accidentellement.

Pour régler la hauteur du guidon, desserrez la manette sélectionner les trous appropriés et serrer la vis de réglage.

(1) manette

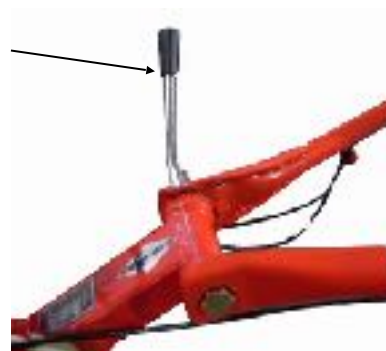
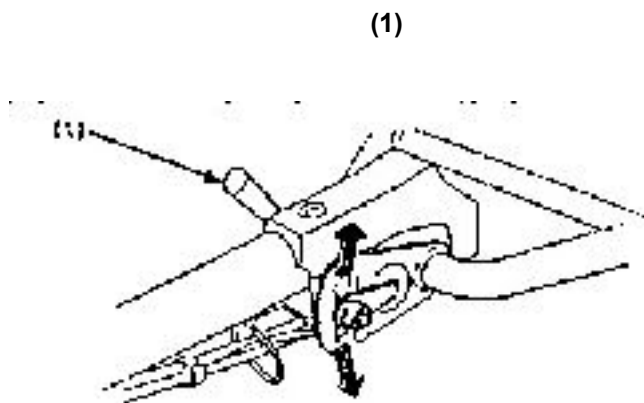

Installez la fixation dans la zone d'attelage avec une goupille.

Le réglage de la profondeur de travail peut être effectué comme suit : Retirer la goupille et verrouillez la barre, desserrer le boulon de fixation de la barre et glisser la barre vers le haut ou vers le bas si nécessaire.

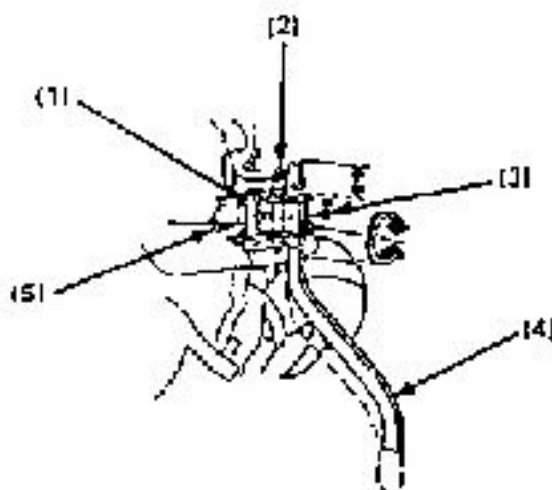

2. Embrayage

L'embrayage engage et désengage la puissance du moteur à la transmission.

Lorsque le levier d'embrayage est pressé, l'embrayage est engagé et la puissance est transmise.

Appuyez sur le levier. L'outil tournera.

Lorsque le levier est relâché, l'embrayage est désengagé et la puissance ne se transmet pas. Relâchez le levier d'embrayage. L'outil s'arrêtera.

Attention: Réduire le régime moteur avant d'intervenir sur le boîtier de transmission.

(1) levier embrayage

(2) engagé

(3) désengagé

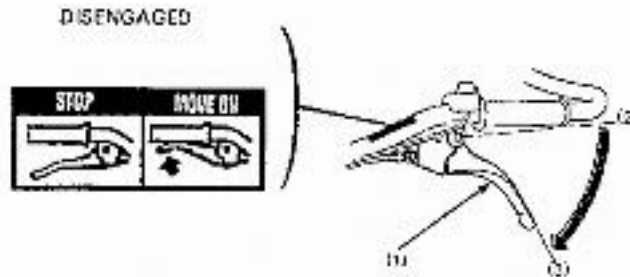

3. Sélection Vitesses

Le levier de changement de vitesse doit être utilisé conformément à la plaque de changement de vitesse fixée

Levier vitesse :

1. Retourner la manette d'accélérateur à l'extrême droite.

2. Relâchez le levier d'embrayage pour le désengager

3. Placez le levier de changement de vitesse à la position de vitesse souhaitée

NOTE: Si le levier de changement de vitesse ne sera pas engager la vitesse souhaitée presser le levier d'embrayage et déplacer légèrement le motoculteur pour repositionner les engrenages.

4. Appuyez sur le levier d'embrayage pour engager l'embrayage.

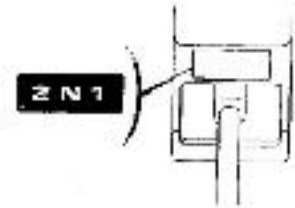

4. Choisir la vitesse

La motobineuse a trois vitesses au choix:

Boîtier conversion:

(1) Tirer le commutateur d'accélérateur vers la droite

(2) Desserrer la poignée d'embrayage et laisser l'embrayage séparé.

(3) Déplacement le bras de changement de vitesse à votre vitesse choisie

(4) En actionnant la poignée d'embrayage, le moteur va travailler sur le rapport de vitesse choisie convertie

levier vitesse
Arriere (-1), Avant (1), Neutre (0), Avant(2)

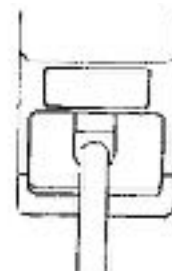

5. Installer la liaison sur le boîtier d'attelage avec la goupille

- (1) Boîtier
- (2) Goupille

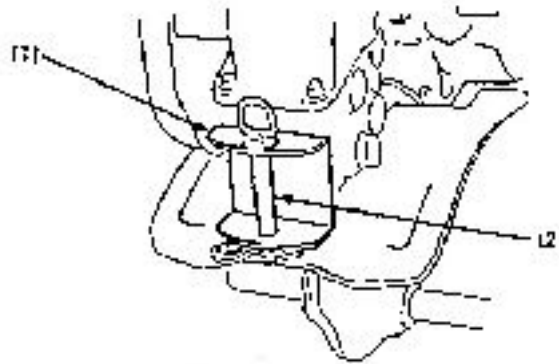

6. Roue frontale

Bouger la motobineuse sur un sol plat; la basculer vers l'arrière en appuyant sur le guidon
Lorsque la motobineuse est utilisée dans la terre, déplacer la roue par l'action de la goupille de verrouillage.

- (1) position dans la terre
- (2) goupille
- (3) sur route

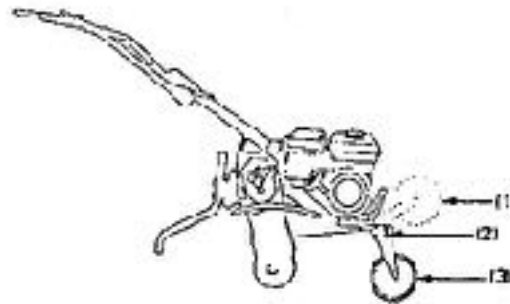

7. Position travail

Ajustez la hauteur du guidon dans une position confortable (hauteur de la taille pour le labourage normal). Si vous ressentez des secousses de la machine vers l'avant pendant le labourage. Appuyez sur le guidon. Si la machine n'avance pas, déplacez le guidon de gauche à droite.

Tourner: La méthode appropriée pour négocier un virage lors d'une opération de labour est d'abaisser le guidon pour ramener le centre de gravité vers l'arrière, puis faire le tour.

8. Angle Normal de travail

Abaissez légèrement la poignée de sorte que l'avant de la machine soit soulevée de 6-8°

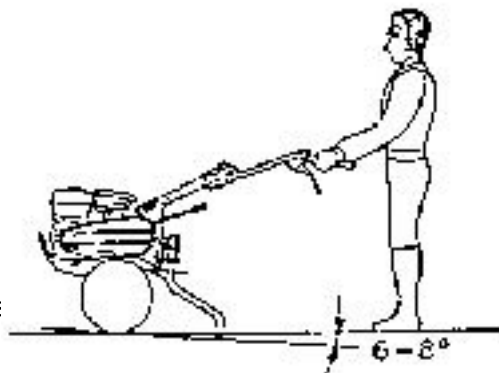

Pour obtenir le maximum d'avantages:

la machine avec cet angle tant que

vous êtes en labourage du sol

Attention:

* Ne pas utiliser le motoculteur avec un jeu de fraises dont le diamètre est supérieur à 300 mm.

* Ne pas permettre l'utilisation de la motobineuse à une personne non informée

- Porter des vêtements appropriés
- Ne pas utiliser la motobineuse dans la nuit.
- Deux personnes pour transporter la barre d'un endroit à l'autre sans l'aide d'un support.
- Lorsque le rotor est bouché avec de la boue, graviers, etc. immédiatement arrêter le moteur et nettoyer le rotor dans un endroit sûr. Soyez sûr de porter des gants épais lors du nettoyage du rotor.

SI URGENCE :

Tourner l'interrupteur sur "OFF"

- (1) OFF
- (2) interrupteur

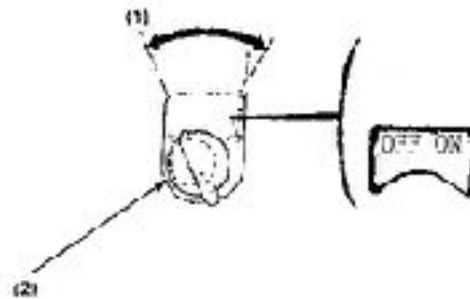

En conditions normales :

Relâchez le levier d'embrayage en position débrayée et le levier de vitesses en position neutre

- (1) Levier embrayage
- (2) Desengagé

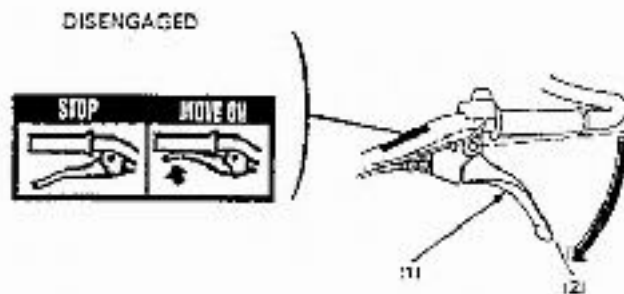

1. Déplacez la manette des gaz vers

- (1) manette gaz

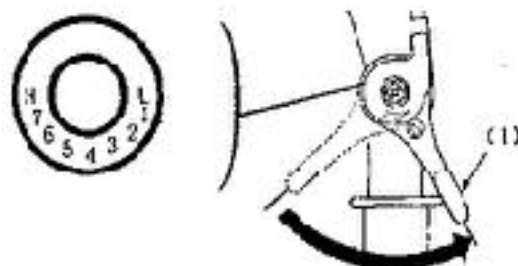

2. Tourner l'interrupteur sur OFF

- (1)OFF
- (2) Interrupteur

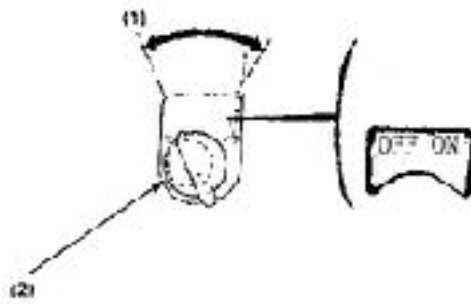

3. Tourner l'arrivée d'essence sur OFF

- (1) Robinet essence
- (2)OFF

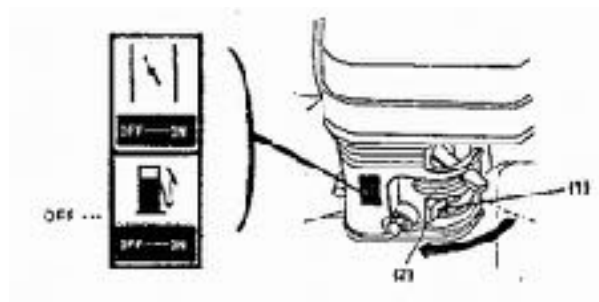

6. ENTRETIEN :

Le but du programme d'entretien est de garder la motobineuse dans le meilleur état de fonctionnement.

 **WARNING** Arrêtez le moteur avant toute intervention. Si le moteur doit être rallumé lors de test, vérifier que vous êtes dans un espace ventilé.

Attention : Toujours utiliser des pièces d'origine

Tableau

Action entretien		jour	1 Mois Ou 20 Hrs.	tous 3 mois Ou 50Hrs.	tous 6 mois ou 100 Hrs.	tous ans year ou 300 Hrs.
huile moteur	contrôle niveau	o				
	Changer		o		o	
filtre air	contrôle niveau	o				
	nettoyer			O(1)		
arrivée essence	nettoyer				o	
bougie	nettoyer-reajuster				o	
huile transmission	contrôle niveau	o				
poussoir	controle-réajuster					O(2)
réservoir essence	nettoyer					O(2)
cable embrayage	Ajuster		o		o	
accélération Cable	Ajuster					o
courroie Tension	Ajuster		o		o	

1. Changement Huile :

Faire couler l'huile quand le moteur est chaud afin de vidanger plus facilement et complètement.

- (1) Enlever le bouchon de vidange et faire couler l'huile
- (2) Remplir d'huile propre (voir page 9) et contrôler le niveau

Capacité d'huile: 0.6 L

- (1) Bouchon vidange
- (2) Jauge
- (3) Niveau haut

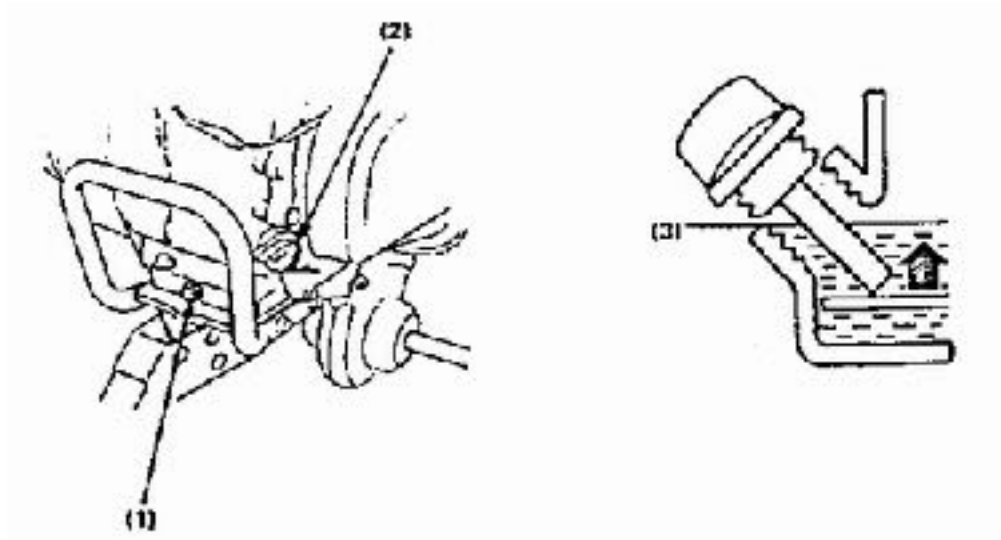

NOTE: Les huiles usagées doivent être remises à un organisme habilité et surtout ne pas les jeter dans la nature, ni les poubelles habituelles.

2. Filtre Air

Prévoir un nettoyage fréquent surtout lors d'utilisation dans des endroits poussiéreux.



Ne jamais utiliser d'essence ou solvant pour le nettoyer. Risque d'explosion.

Attention: Ne jamais faire tourner le moteur sans filtre à air, sinon la poussière rentrerait dans le moteur et l'endommagerait.

* L'élément mousse: le nettoyer avec de l'eau savonneuse et bien l'essorer après. L'imbiber légèrement d'huile moteur en le malaxant.

* L'élément papier: Le tapoter pour enlever les saletés, ne pas le souffler à l'air comprimé, ni le laver. Si op sale, vous devez le changer.PAPER ELEMENT

(1) filtre papier

(2) filtre mousse

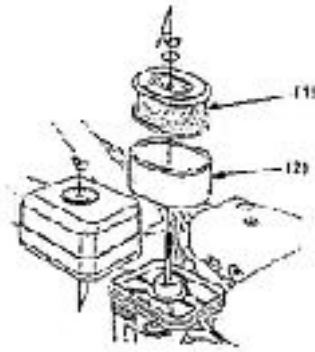

3. Bouchon vidange carburateur

Fermer l'arrivée d'essence (position OFF) et enlever la vis de vidange et son joint.

Nettoyer et laisser couler et resserrer l'ensemble

(1) joint

(2) vis vidange

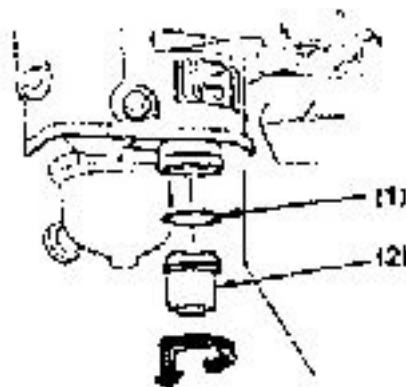

4. Bougie

Bougie recommandée : BPR5ES (NGK)

W16EPR-U (NIPPONDENSO)

- Enlever le capuchon de bougie

⚠ WARNING Si le moteur vient de fonctionner, prendre les précautions pour éviter de vous brûler avec le pot d'échappement..

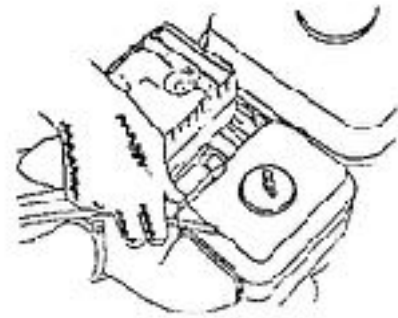

- contrôle visuel de la bougie.
- mesurer le jeu à l'électrode qui doit être de 0.7-0.8mm (0.028-0.031in).

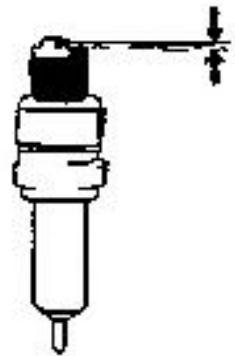

- remettre la bougie dans son emplacement.

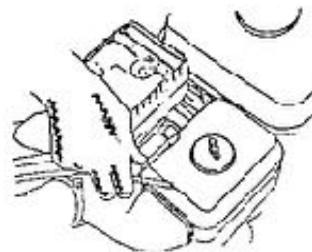

Attention:

Une bougie doit être serrée fermement. Un mauvais serrage peut endommager le moteur.

5. Ajustement du câble d'embrayage

Mesure le jeu au niveau de la poignée

Jeu : 3-8mm (0.1-0.3in)

Si incorrect, desserrer l'écrou et régler pour obtenir cette course.

(1)écrou

(2)écrou ajuster

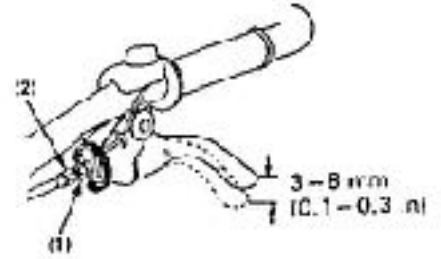

Après ajustement serrer l'écrou de blocage en toute sécurité. Ensuite, démarrer le moteur et vérifier le bon fonctionnement du levier d'embrayage.

6. Ajustement câble accélération

Mesurer le jeu à la poignée

Jeu: 5-10 mm (0.2-0.4in)

Si incorrect, desserrer l'écrou et régler pour obtenir cette course.

(1) levier accélération

(2) écrou ajustement

(3) écrou

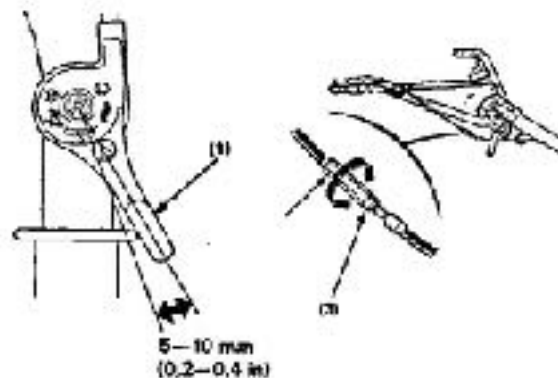

7. Ajustement courroie

Régler le jeu du levier d'embrayage

La tension de la courroie normale doit permettre un espace de 60-65mm (2.4-2.6 in) au niveau de la poulie de tension, moteur embrayé (levier d'embrayage est pressé).

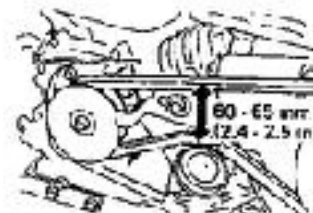

Desserrer les boulons de fixation de l'arrêt de courroie

Ajuster le jeu entre la butée de courroie et la courroie comme illustré avec le levier d'embrayage pressé.

(1) arrêt courroie

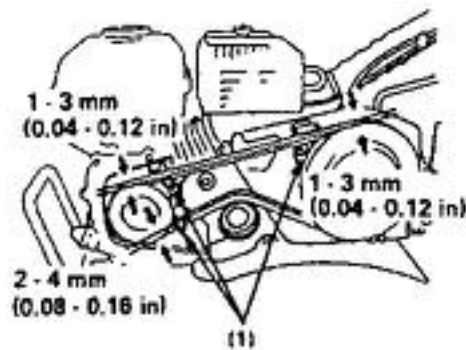

7. TRANSPORT / STOCKAGE

WARNING

Quand vous transportez la motobineuse, toujours fermer l'arrivée d'essence. Des fuites peuvent se passer et les vapeurs d'essence provoqueraient un risque d'incendie.

1. la zone de stockage doit être sèche et propre.

2. vidangez l'essence dans le réservoir et carburateur

3. Tirer la poignée du lanceur jusqu'à sentir une résistance et la dépasser. Continue tirer jusqu'à ce que l'encoche sur le lanceur est aligné avec le trou sur le lanceur

À ce stade, les soupapes d'admission et d'échappement sont fermées, ce qui contribuera à protéger le moteur contre la corrosion

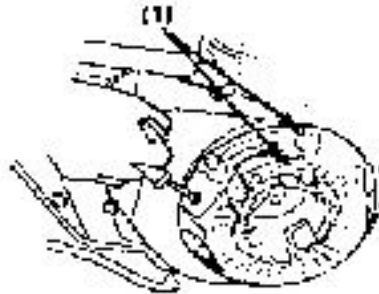

4. Changer l'huile moteur

5. protéger avec une bâche la motobineuse

Ne pas placer la motobineuse en portée sur le guidon, car l'huile irait dans le cylindre.



EN

SEMI-PROFESSIONAL TILLER DAC 6500K/ACC





CONTENT

1. Introduction.....	4
2. Safety instructions	5
2.1 Machine warnings	5
3. Machine overview.....	6
4. Technical data	7
5. Assembly	8
6. Fuel and oil supply	13
6.1 Oil supply	13
6.2 Fuel supply.....	14
7. Pre-operation checks	14
8. Running-in period	15
9. Commissioning.....	15
10. Symptomatic starting problems	18
11. Maintenance	18
12. Packing and storage of machinery	19
12.1 Packing	19
12.2 Storage	20
13. Accessories compatible with the machine	20
14. Coupling of accessories	23
14.1 Plug coupling.....	23



14.2 Coupling of potato plough..... 24

14.3 Cultivator coupling..... 25

14.4 Adjustable ditcher coupling..... 26

14.5 Trailer coupling..... 27

14.6 Water pump coupling 28

14.7 TS3 3 row seed coupling..... 29

14.8 Coupling high precision sowing drill PTS2..... 30

14.9 Coupling the snow plough 30

15. Coupling depth adjustment bracket and burial plug 31

15.1 CRT mowing system 32



1. INTRODUCTION

Dear customer!

Thank you for your decision to buy a RURIS product and for your trust in our company! RURIS has been on the market since 1993 and in that time has become a strong brand, building its reputation by keeping its promises, but also by continually investing to help customers with reliable, efficient and quality solutions.

We are convinced that you will appreciate our product and enjoy its performance for a long time. RURIS offers its customers not just machines, but complete solutions. An important element in the relationship with the customer is the advice both before and after the sale, RURIS customers have at their disposal a whole network of partner shops and service points.

To enjoy the product you have purchased, please read the user manual carefully. By following the instructions, you will be guaranteed a long use.

RURIS is continuously working on the development of its products and therefore reserves the right to change their shape, appearance and performance, among other things, without prior notice.

Thank you once again for choosing RURIS products!

Information and customer support:

Phone: 0351.820.105

e-mail: info@ruris.ro



2. SAFETY INSTRUCTIONS

2.1 MACHINE WARNINGS



Warning! Danger!



Read the instruction manual before using these machines.



The operator must wear Personal Protective Equipment (PPE). If the machine is in use, goggles must be worn to protect against objects projected into the air; hearing protection items such as soundproof headphones must be worn.



Do not damage the manual. Keep it for future reference.



Electricity hazard.



Do not use flammable solutions near the machine.



Avoid contact with moving parts of the machine.



Avoid areas with high machine temperatures.



Do not operate the machine in enclosed spaces.



3. MACHINE OVERVIEW

The tiller consists of the following elements:

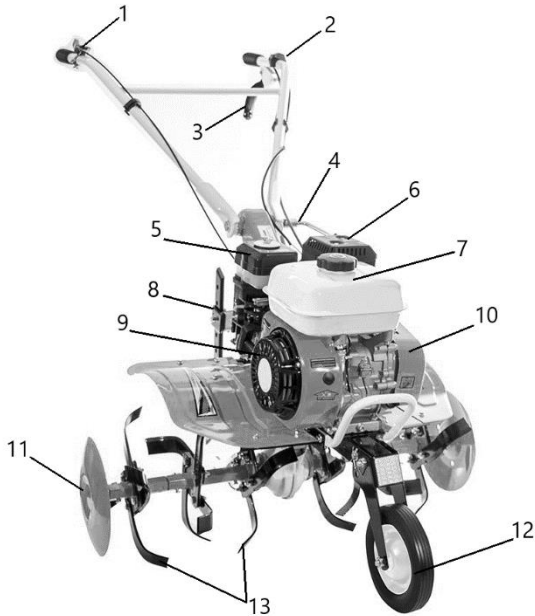

- 1. Throttle lever 6. Muffler 11. Disk
- 2. On/Off switch 7. Fuel tank 12. Transport wheel
- 3. Clutch lever 8. Depth adjustment bracket 13. Cutting knives
- 4. Horn adjustment lever 9. Starter
- 5. Air filter 10. Belt protection



4. TECHNICAL DATA

WARNING:

The tiller is not supplied with oil in the engine unit. Before putting into service, check and fill up with the recommended engine oil according to the instructions in the manual.

There is oil in the engine oil bath below the level, which is only for preservation and not for operation.

Model	DAC 6500K/ DAC 6500ACC
Weight (with knives)	80 kg
Engine	4-stroke
Engine manufacturer	General Engine
Cylinder capacity	208 cc
Power	7 HP/5.2 kW
RPM	Max 3600 Min 2000
Consumption litres/h	250 ml/kwh
Fuel	Gasoline

Use the machine for the purpose for which it was designed, i.e. soil tillage. Any other use could be dangerous and could damage the equipment. Do not use to cultivate ground containing rocks, stones, wire or any other hard material.

Change engine oil every 25 hours of operation and transmission oil every 50 hours of operation or 6 months



5. ASSEMBLY

The video can be viewed at: <https://www.ruris.ro/filme-montaj>

Component parts

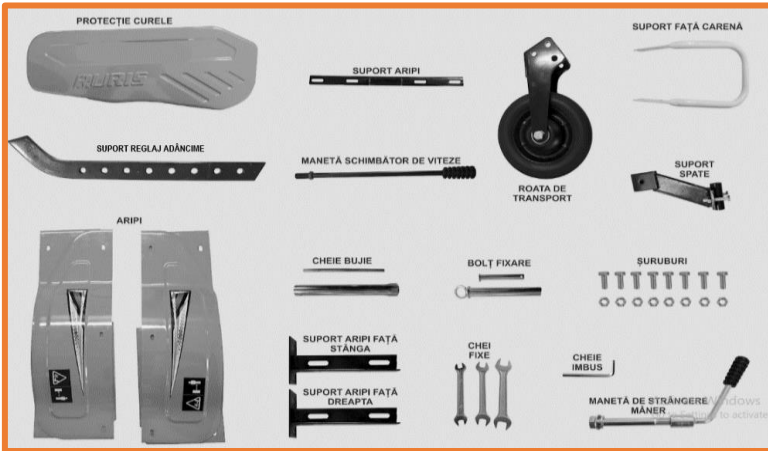

Mount the front bracket and the left/right wing supports.

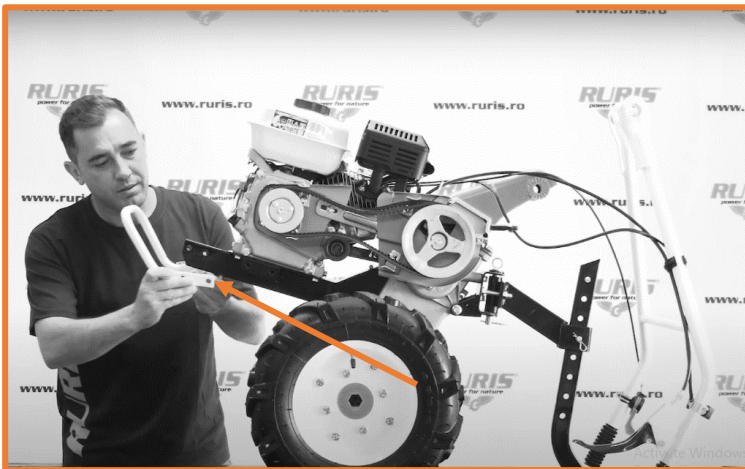

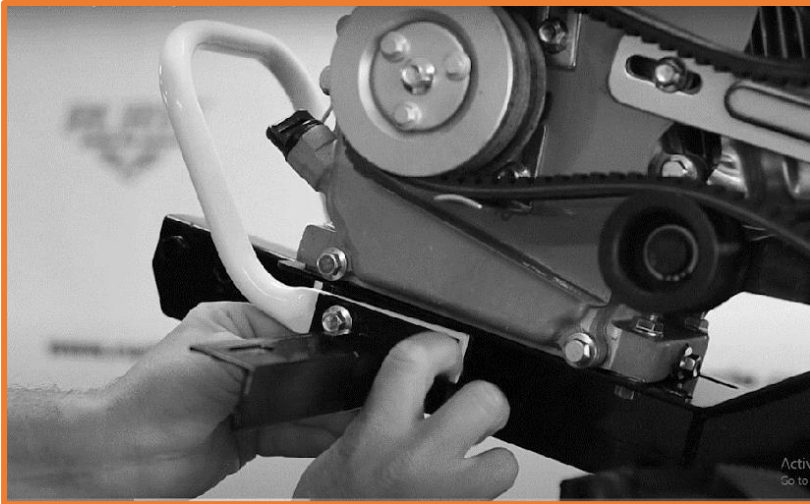

Mount front wheel and secure with bolt + bolt





Mount the horns and secure them with the handle clamp lever. (depending on horn model)

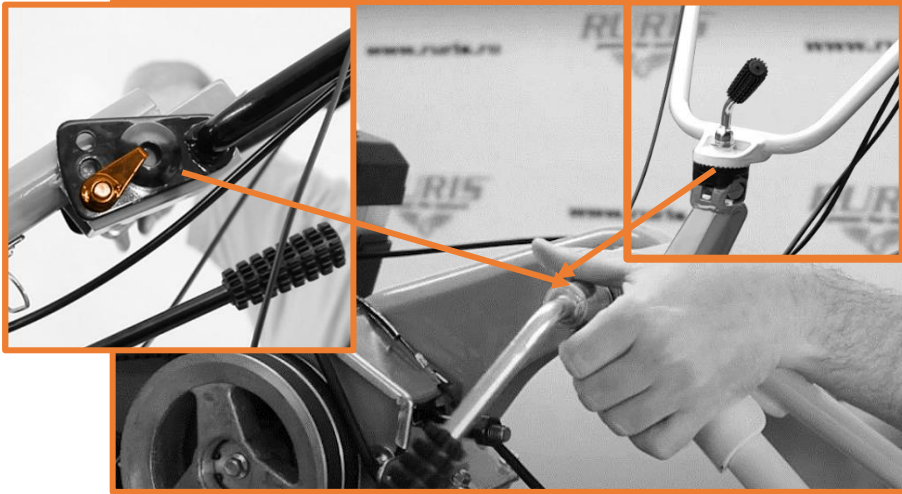

Mount the rear wing support.





Fit the protective wings.



The gearbox is mounted and locked with the bolt - fuse.



To achieve this it is necessary to dismantle the pulley.

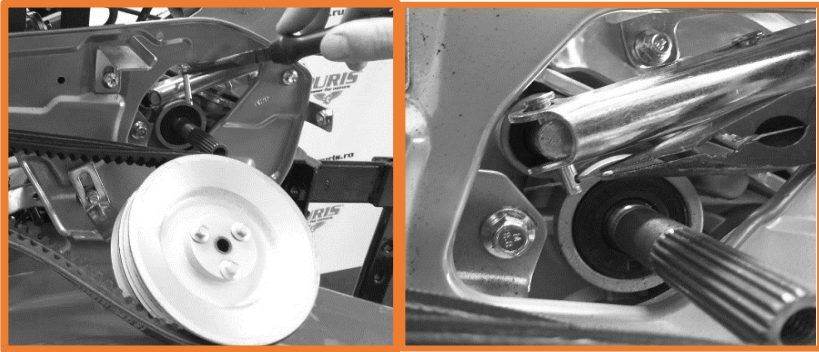
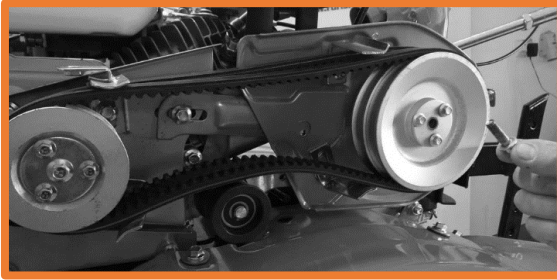

Mount the strap guard and secure it with screws.



The images are for information only, the supplier reserves the right to make structural and functional changes to the machine shown in this manual.



6. FUEL AND OIL SUPPLY

6.1 OIL SUPPLY

Engine oil supply

Before starting the engine, fill the engine with RURIS 4T-MAX oil or an oil of API classification: CI-4/SL or higher.

The tiller is not delivered with oil in the engine.

Engine oil bath capacity 0,6L

WARNING:

- Do not use reverse for digging or transporting over a distance of more than 10m for a single drive.
- Check that the oil level is correct by unscrewing the plug (oil dipstick) located on the crankcase and see if the oil reaches the first top thread at the top filler. The check is carried out with the engine positioned horizontally.



WARNING:

Always, before each start, pull the starter rope on the engine gently 4 times at the most (starter button in the OFF position) so that the oil penetrates all the cylinder ports, valves.



Otherwise, if you attempt to start the engine suddenly by pulling the starter rope directly, you risk engine seizure or serious engine damage.

Transmission oil supply

The capacity of the transmission oil bath is 1600 ml.

Use RURIS G-Tronic transmission oil or an oil of API classification: GL-4 or higher. The maximum oil level of the gearbox is at the bottom of the oil filler hole on the right side of the gearbox.

The tiller is not supplied with oil in the gearbox bath.

TRANSMISSION OIL CHANGE EVERY 50 OPERATING HOURS

6.2 FUEL SUPPLY

Use quality fuel from authorised petrol stations.

Fuel with the highest quality UNLEADED GASOLINE type fuel, using a metal funnel, in open spaces and away from sources of fire or sparks, which could cause a fire.

WARNING:

Do not feed on the ground or around plants as you risk damaging the environment.

7. PRE-OPERATION CHECKS

1. Check that all screws are tight and adjust if necessary.
2. Check each handlebar lever (throttle, gearshift and reverse) for functionality. If the handle positions are incorrect, adjust them to be in the proper positions.
3. Move the gearshift to neutral.
4. Oil topping up.
 - Fill the engine oil sump with RURIS 4T- MAX lubricating oil.
 - Place the machine on a flat surface while you feed transmission oil into the gearbox.



- To check the oil level use the dipstick, the oil must be at full level.
 - Check for oil leaks.
 - Add oil to the air filter.
5. Clean the unit of dust and dirt, especially the air filter.

8. RUNNING-IN PERIOD

The tiller should run for 5 hours under light load. After this period, change the oil in both the transmission and the engine. Then fill the transmission oil sump with RURIS G-Tronic or an oil of API classification GL-4 or higher and the engine oil sump with RURIS 4T-MAX or an oil of API classification CI-4/SL or higher.

Unleaded gasoline will be used in the tiller.

It is recommended that before use the gasoline is decanted and filtered through a metal sieve.

9. COMMISSIONING

It is forbidden to idle the engine without load for more than 5 minutes as you risk damaging the drive belts.

The engine fitted to your tiller is factory run-in and does not require idling.

Before starting up the tiller, you must ensure that the following conditions are met:

- fill the air filter container with clean engine oil to the maximum level indicated
- there are no persons or objects within a radius of 5 metres on either side of the tiller with which it could come into contact
- the tiller is placed horizontally
- the front wheel is mounted and raised off the ground



- the engine has oil in the bath at maximum level
- the gearbox has full oil level
- the engine has a minimum of 500 ml of gasoline in the tank
- the cutting knives are secured with the fixing bolts or, if transport wheels are fitted, they are secured with the fixing bolts and the tyre pressure is between 1,5-2 bar
- all the bolts of the tiller are properly tightened

Starting the engine

- position the choke flap in the direction indicated for cold start.

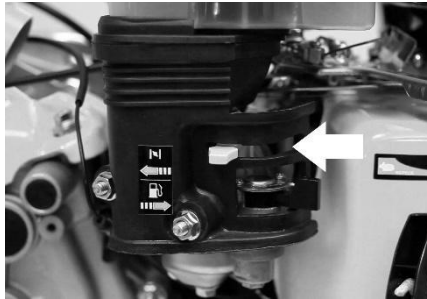

Position the gasoline tap flap in the direction indicated.

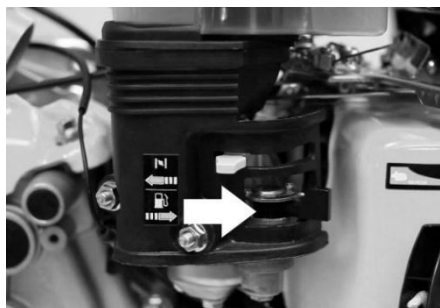



- pull the starter rope 4 times, gently, to prime all the internal engine holes with oil
- fully depress the throttle lever (in position H)
- turn the ON/OFF switch to the ON position



- pull steadily and firmly on the starter rope from the engine, after pre-tensioning it (pull gently until you meet the compression resistance of the engine)
- position the gearbox in the desired gear and use your left hand to squeeze the cutting knife lever. They will start to rotate
- move the throttle gently in the opposite direction until the engine is operating within its parameters, i.e. it has no symptoms of stopping

WARNING:

Release the cutter lever and the cutters will stop.

If you hear a continuous slipping noise when coupling, or if the chain saw does not move, check the cutter drive cable once again, as it has been set to a short travel.

NOTE:

Coupling must always be done at full engine speed, otherwise you risk damaging the belt.

At this point you can start digging the soil.



10. SYMPTOMATIC STARTING PROBLEMS

- check that the oil in the engine is at the right level, as the engine fitted to your tiller may have an oil sensor that switches off the spark plug if it is not at full level in the engine
- check that the fuel tap is open in the indicated position
- check that you have fuel in the tank and that it is adequate (no fuel other than that indicated or older than 1-2 weeks)
- check that the throttle lever is fully engaged
- check that the shock flap is in the closed position
- check that the air filter is not clogged with impurities
- replace the spark plug with a new one

11. MAINTENANCE

- after each use clean the air filter and replace the oil in the filter chamber with a clean one if necessary or when replacing the oil in the engine.

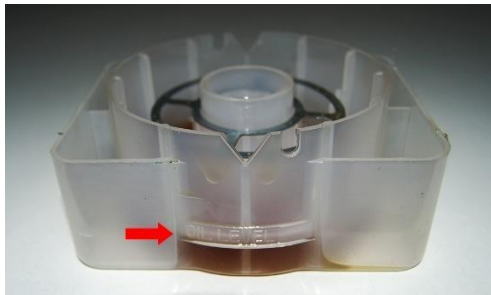

- after each use clean the cutting knives and check them
- after each use, grease the shaft on which the cutting knives are fixed with Vaseline
- adjust the cables if you notice that the knives do not respond to commands or stop on load
- change transmission/engine oil every 50/25 hours or 6 months.



Fitting/removing the transmission drive belt

This is done as follows:

- removing the side cover of the protective housing
- the actual removal of the belt
- mount the new transmission belt
- mount the protective cover

If you remove the belt tensioner, it will be mounted and aligned after the new belt by keeping the original position of the adjusting bushing or rotating it 180 degrees according to step 7 in the installation guide, so it will be on the same axis, protecting and not damaging the drive belt.

NOTE:

The replacement of the couplings should only be carried out by an authorised Service Centre, as they have different tightening of the screws that secure them.

If after a long period of operation, the tensioner no longer works at full capacity, the belt slipping under load, the drive cable should be adjusted.

12. PACKING AND STORAGE OF MACHINERY

12.1 PACKING

Packed in sealed cardboard boxes for easy movement.

Inside you will find:







- user manual
- guarantee certificate
- tiller
- kit of keys



12.2 STORAGE



- The tiller must be stored in a dry place with a roof and protected against dampness, in rooms with windows and adequate ventilation.
- The fuel should be drained from the tank, the fuel tap turned off and the machine allowed to run until all the fuel in the carburettor is consumed.
- Active metal parts must be greased with Vaseline
- Oil must be left in the engine bath during storage
- Engine oil must be replaced if the tiller has been stored for more than 6 months.

13. ACCESSORIES COMPATIBLE WITH THE MACHINE

Adjustable wagon 	Ditcher TS103 	Potato plough TS 
Cultivator TS103 	Multifunctional cultivator with two rows 	Snow blade 



<p>PTS2 high precision drill</p> 	<p>TS3 3-row seed drill</p> 	<p>Set of rubber wheels 400x8 TS103</p> 
---	--	--

<p>Set of metal wheels 350 TS 103</p> 	<p>Set of metal wheels 400 TS 103</p> 	<p>TS100 gearbox</p> 
<p>Universal hub with lock TS103</p> 	<p>TS103 universal hub set</p> 	<p>Set of hubs with lock CRT280</p> 



<p>Water pump</p> 	<p>Trailer: 550 kg load capacity</p> 	<p>Trailer: 450 kg load capacity</p> 
<p>Towed accessory Navigator 88</p> 	<p>CRT570 mower system</p> 	<p>Adapter accessories</p> 



14. COUPLING OF ACCESSORIES

14.1 PLOUGH COUPLING

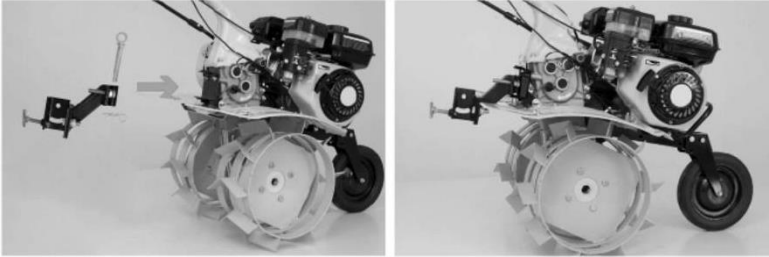

1. Mount the accessory adapter and secure with the bolt.

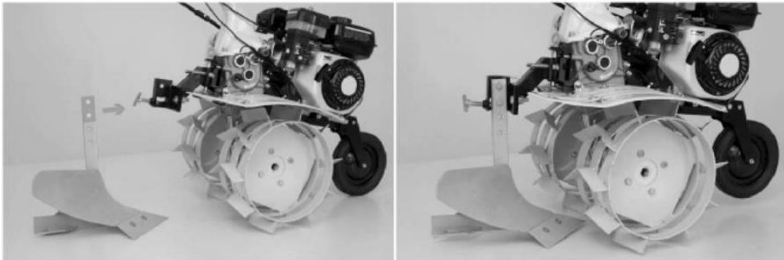

2. Attach the plough to the adapter and secure with two screws.



14.2 COUPLING OF POTATO PLOUGH

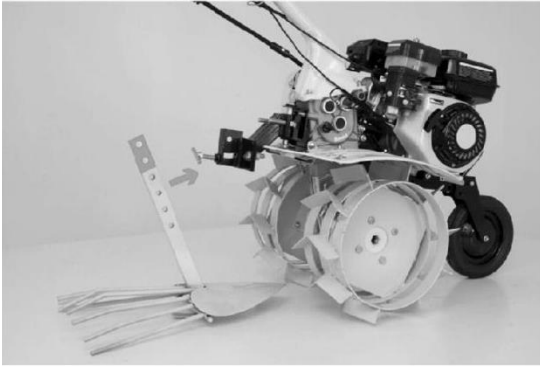

1. Use the accessory adapter

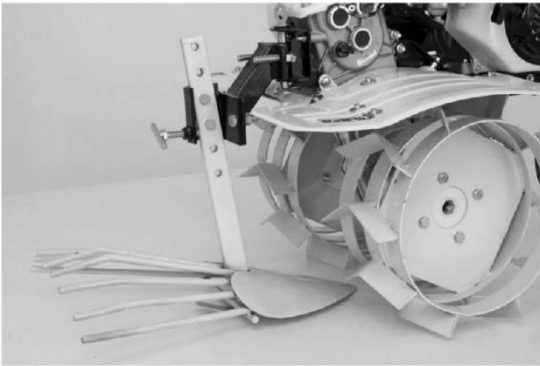

2. Fit the potato plough
and secure it with two screws



14.3 CULTIVATOR COUPLING

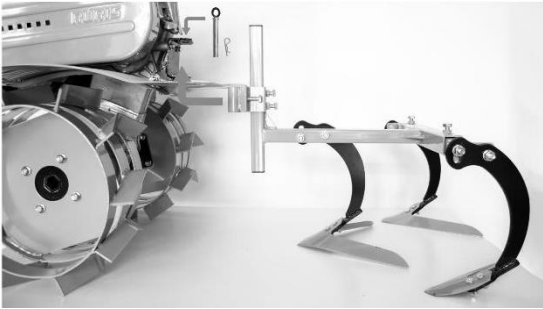

1. The cultivator is coupled using the bolt and safety catch provided





14.4 ADJUSTABLE DITCHER COUPLING

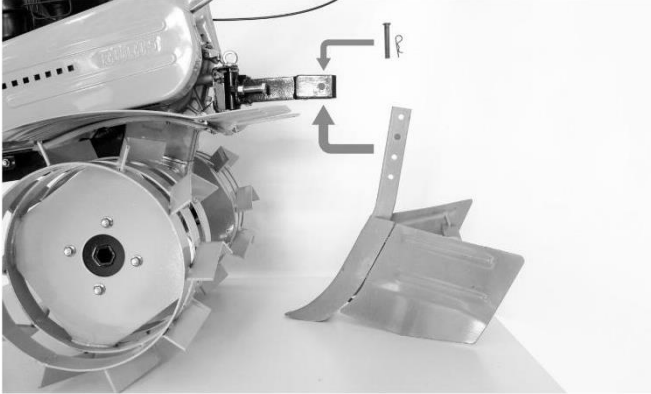

1. The ditcher is coupled using the bolt and safety catch provided

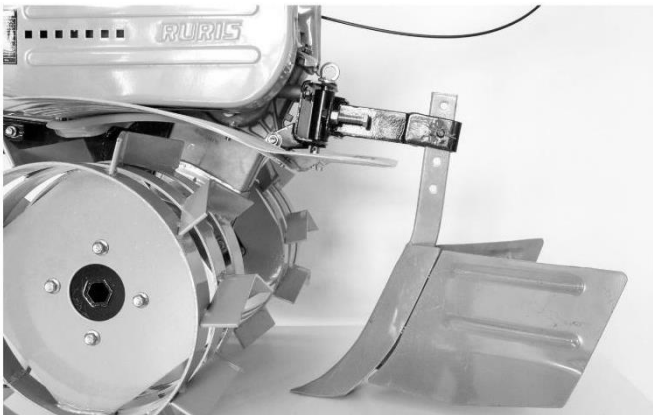



14.5 TRAILER COUPLING

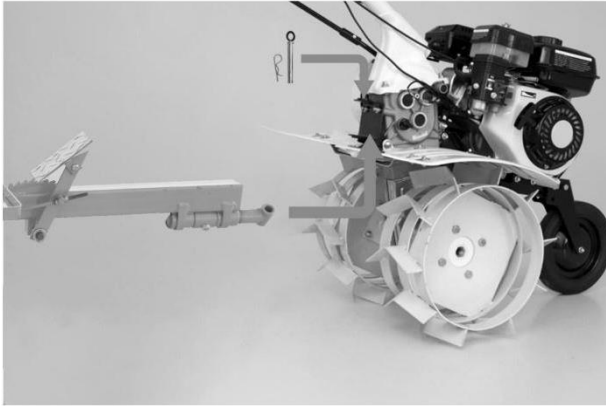

1. The trailer is coupled using the bolt and safety catch provided

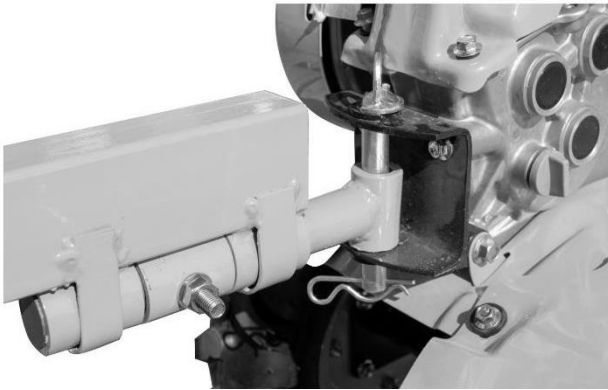



14.6 WATER PUMP COUPLING

Step 1

Detach the handle of the chain saw, then mount the pump foot with the 2 screws.
Beforehand, fit the belt adjustment screw.

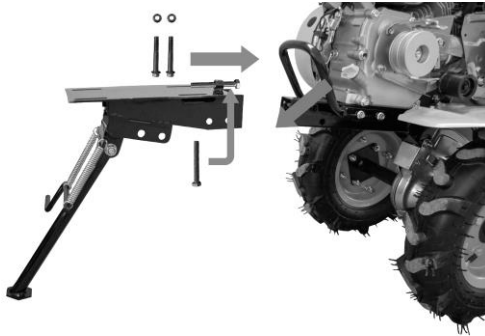

Step 2

Mount the pump body with the 4 screws.

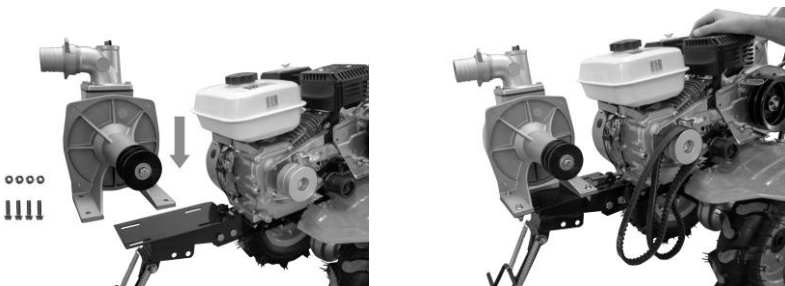



Step 3

Fit the two straps and adjust with the screw.



14.7 TS3 3 ROW SEED COUPLING

1. The seed drill is coupled using the bolt and safety catch provided

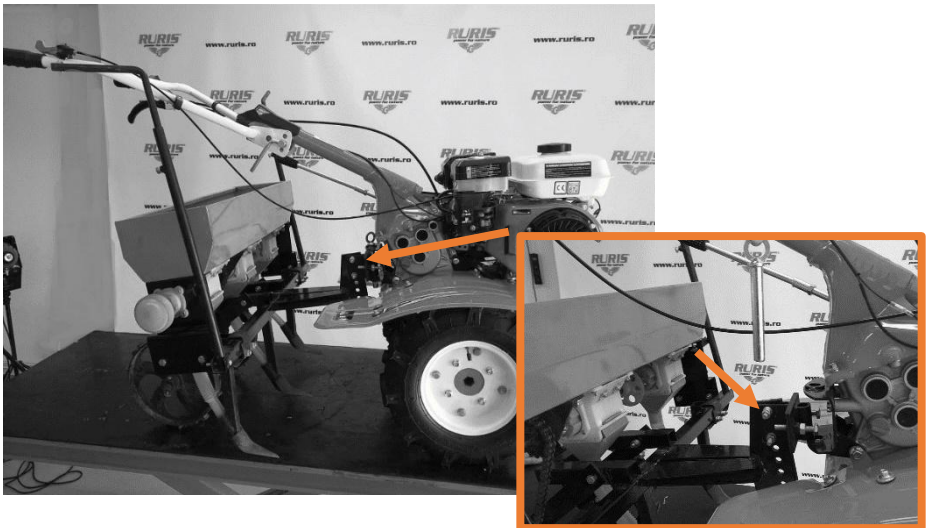



14.8 COUPLING HIGH PRECISION SOWING DRILL PTS2

1. The seed drill is coupled using the bolt and safety catch provided

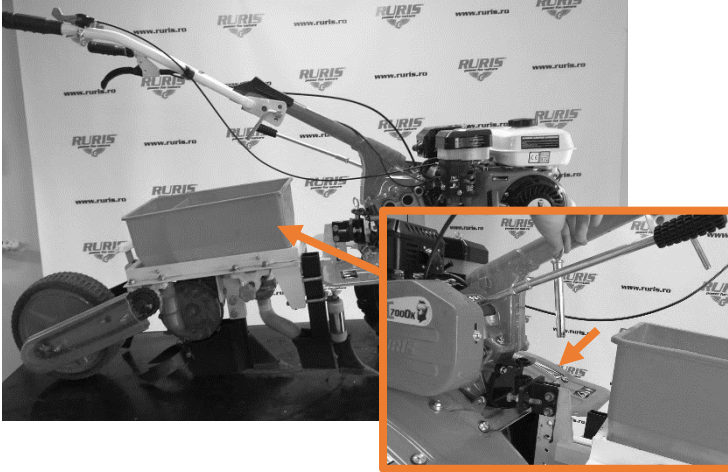

14.9 COUPLING THE SNOW PLOUGH

1. Snow blade is coupled using the screws provided

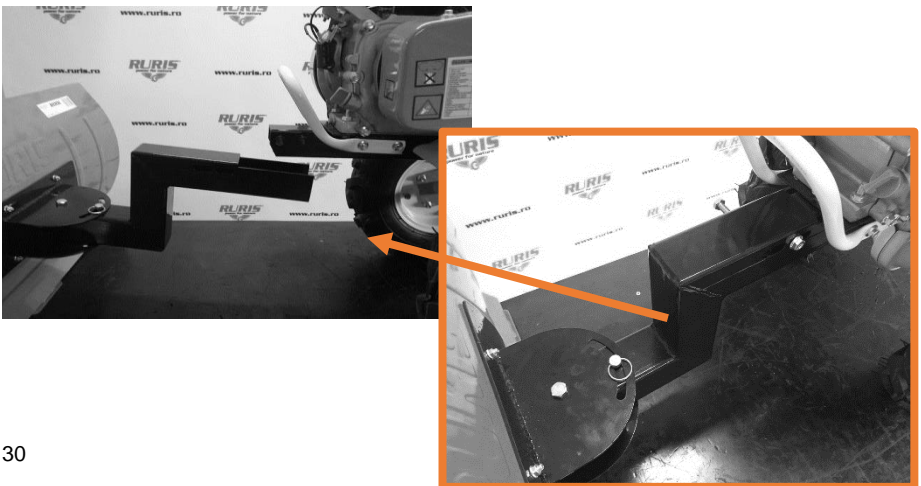



15. COUPLING DEPTH ADJUSTMENT BRACKET AND DITCHER

1. Depth adjustment bracket and plough are coupled using the supplied screws





15.1 CRT MOWING SYSTEM

1, Installation guide is in the accessory box





Motosapa/Мотокопачка/ DAC 6500K / DAC 6500 ACC

- оригинални инструкции -

Въведение

Мотокопачки DAC са мотокопачки, оборудвани с верижно задвижване, лесни за поддръжка, за да се насладите на лесна работа.

Мотокопачки DAC се препоръчват за обработка на леки почви, слънчеви, предварително третиран почви.

Мотокопачка с верига се използва само за лесно обработване на почвите, особено пясъчни почви.

За да работите по-трудни и по-твърди почви, моля, обърнете се към нашето семейство мотокопачки в каталога на РУРИС

Благодарим Ви, че сте избрали продуктите DAC!

Информация за клиентите и поддръжка:

Тел.: **0351 820 105**

E-mail: **info@ruris.ro**



Защите при работа

Предупреждения



Внимание! Опасност!



Прочетете ръководството за употреба, преди да използвате тези машини

Операторът трябва да носи лични предпазни средства (PPE). Ако машината се използва, носете предпазни очила срещу предмети, проектирани във въздуха; трябва да се носят слухови апарати като акустично изолирана каска.



Използвайте защита на ръцете (ръкавици).



Използвайте защита на краката.



Опасност:
Опасни предмети, хвърлени при удара с диска, ножове.

Пазете се на дистанция от открит пламък. Не пушете. Не изхвърляйте гориво. Не захранвайте докато двигателят работи или е горещ.



Компоненти на мотокапачката

Motosapa се състои от следните елементи:

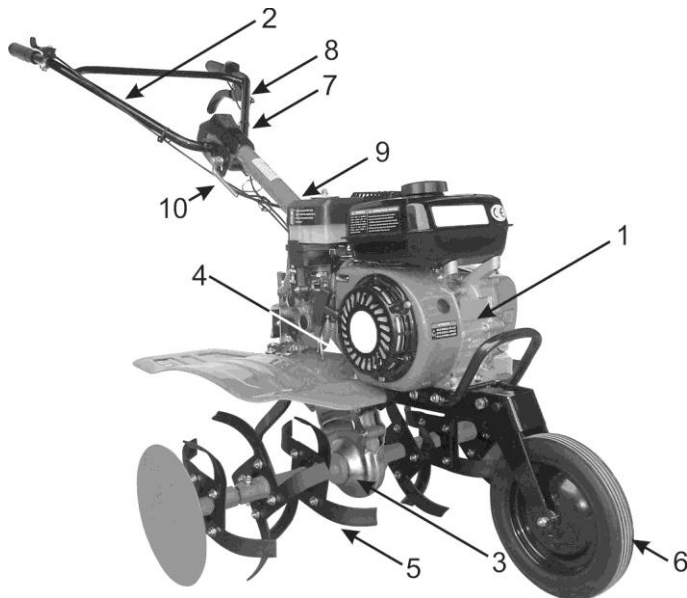

Fig. 2

1. двигател
2. рога(ръкохватки)
3. корпус на защитна трансмисия
4. стартер
5. режещи ножове
6. транспортно колело
7. поддръжка за регулиране на височина
8. съединителен кабел(жило)
9. поддръжка на рогата(държач на ръкохватките)
10. кабел(жило) за ускорението

Техническа характеристика

ВНИМАНИЕ:

- Мотокапачка DAC 6500K / DAC 6500 ACC не се доставя с масло в двигателя и горивото. Преди пускане в експлоатация, проверете и напълнете с моторно масло, както е указано в ръководството.
- В резервоара на маслото на двигателя има масло под нивото, което е само за консервиране, а не за работа



Модел	DAC 6500K / DAC 6500 ACC
Тегло (с ножове)	80 kg
Двигател	4 timpi
Производител на двигателя	General Engine
Капацитет на цилиндъра	208 cmc
мощност	7 CP/5.2 kW
RPM	Max 3600 Min 2000
Консумация литри/h	250 ml/kwh
Гориво	Безоловен бензин

Използвайте машината за целта, за която е предназначена, а именно за обработката на почвата. Всяка друга употреба може да бъде опасна и да повреди оборудването. Никога не го използвайте, за да култивирате земя, съдържаща скали, камъни, жици и други сурови материали.

Смяна на трансмисионното масло на всеки 50 часа работа и двигателя на всеки 25 часа работа

Период на разработване

Мотокопачка DAC 6500K / DAC 6500 ACC тя трябва да работи за 5 часа при леко натоварване, след това източете цялото масло в трансмисионната маслена баня и маслото за двигателни масла. След това захранете маслена трансмисионна баня с масло на Ruris G-Tronic или масло по класификация API: GL-4 или по-високо от същото, както и маслената баня на двигателя с масло на Ruris 4T Max или масло по класификация API: CI-4/SL или по-високо от това..

При мотокопачка DAC 6500K / DAC 6500 ACC се употребява безоловен бензин.

Препоръчва се преди употреба бензинът да се декантира и филтрира през метално сито.

Монтаж

Преди да монтирате и пуснете в експлоатация, трябва да се уверите, че Мотокопачка DAC 6500K / DAC 6500 ACC е монтирана правилно в съответствие с ръководството за монтаж и в съответствие с това ръководство, само след това можете да продължите с правилното пускане в експлоатация.

Захранване на двигателя с масло

Преди стартиране на двигателя, заредете двигателя с масло Ruris 4t Max или масло по класификация API: CI-4/SL или по-високо от това.

Мотокопачката не се доставя с масло в двигателя.

Капацитет на маслената баня на двигателя 0,6L

**ВНИМАНИЕ:**

- не използвайте обратен ход за копане или транспортиране на разстояние повече от 10 м за едно устройство.

Проверете дали нивото на маслото е правилно, като разхлабите бушона(рабуш), намиращ се върху картера на двигателя, и проверете дали маслото достига до първата черта от горе, на горната част за пълнене. Проверката се извършва на двигател, разположен хоризонтално.



Fig. 3

ВНИМАНИЕ

Винаги преди всяко пускане внимателно издърпайте до 4 пъти стартерното въже от двигателя (стартовия бутон в положение OFF), за да може маслото да проникне във всички отвори в цилиндрите и вентилите

В противен случай, ако се опитате да пуснете внезапно двигателя чрез издърпване на стартовото въже директно, рискувате прегряване на двигателя, вентилите и т.н. или сериозно увреждане на същия.

Захранване с гориво

Използвайте качествено гориво от оторизирани станции на Ресо.

Захранвайте с гориво тип БЕЗОЛОВЕН БЕНЗИН от най-високо качество, използвайки метална фуния в открити пространства и далеч от източници на пожар или искри, които могат да предизвикат пожар

ВНИМАНИЕ:

Не се зарежда върху почвата или около растенията, тъй като рискувате да повредите околната среда.

Доставка на трансмисионно масло

Капацитетът на трансмисионната маслена баня е 1500 ml.

Използвайте трансмисионно масло Ruris G-Tronic или масло за сортиране на API: GL-4 или по-високо.

Максималното ниво на маслото на предавката е в долната част на гнездото за подаване разположено от дясната страна на редуктора. (Фигура 3.1)

Мотокопачката не се доставя с масло в банята на скоростната кутия(редуктора).

СМЯНА НА ТРАНСМИСИОННОТО МАСЛО СЕ ПРАВИ НА ВСЕКИ 50 ЧАСА ФУНКЦИОНИРАНЕ



Fig. 3.1



Fig. 3.2

Мощност при функциониране

Забранено е да задвижвате двигателя при празен ход без натоварване, повече от 5 минути, защото рискувате да повредите трансмисионните колани(ремъци).

Двигателят, който оборудва вашата мотокопачка е фабрично разработен и не изисква работа на празен ход.

Преди да пуснете в действие Мотокопачка DAC 6500K / DAC 6500 ACC трябва да сте сигурни, че са изпълнени следните условия:

Напълнете контейнера на въздушния филтър с чисто масло за двигателя до посочения максимум на ниво;

- в рамките на 5-метров радиус на мотокопачката, да няма хора или предмети, с които може да влезе в контакт;
- мотокопачка DAC 6500K / DAC 6500 ACC да е в хоризонтално положение;
- Предното колело е монтирано и повдигнато от земята(fata desol)
- Двигателят има масло в картера(baie) на максимално ниво.
- Скоростната кутия има масло на максимално ниво
- Двигателят има минимум от 500 ml бензин в резервоара;
- Ножовете за рязане са закрепени с фиксиращите болтове или ако са монтирани транспортните колела, те трябва да бъдат закрепени с фиксиращите болтове и налягането в гумата да е между 1,5-2 бара

Всички болтове на мотокопачката да са правилно затегнати;

Пуск на двигателя

включете смукач(ударен клапан) на двигателя,

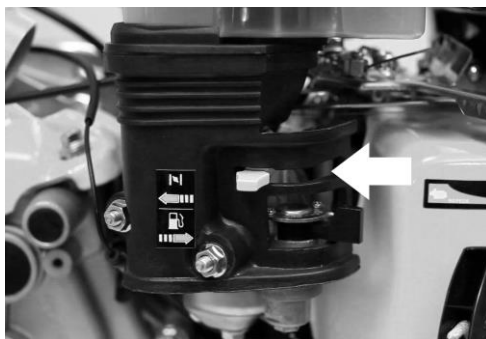

Fig. 4



- Както е показано на чертежа, превключете клапата на горивната клапа(смукач),

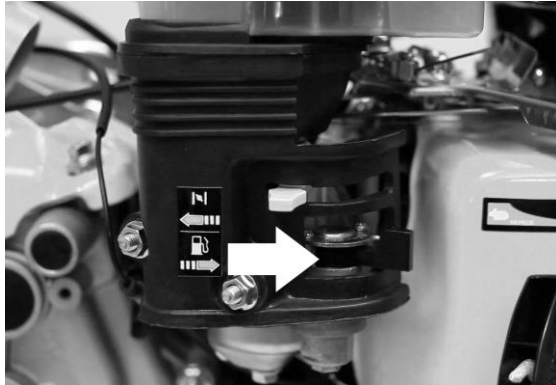

Fig. 5

- По смисъла показан на фиг. 5;
- Издърпайте 4 пъти леко стартерното въже на двигателя, за да заредите всички вътрешни отвори в двигателя;
- Дръжте лоста на дросела напълно (в положение H)
- Включете ключа(бутона) ON / OFF в положение ON.



- Издърпайте здраво лентата на стартера на двигателя, след като го заредите предварително (издърпайте леко, докато издържите на якостта на натиск на двигателя)
- При стартиране на двигателя, леко придвижете до края на хода, в обратна посока на удароустойчивия клапан, докато двигателят работи "кръг оборот", т.е. няма симптоми на спиране;



- Намалете дросела на двигателя наполовина и използвайте левия ръчен лост за затягане на режещите ножове и те ще започнат да се въртят.

ВНИМАНИЕ:

Освободете внезапно задвижващия лост на режещите ножове и те ще спрат.

Ако чуете непрекъснат шум от кънки върху съединителя, или ако мотокопачката не се движи, проверете отново действащият кабел(жило) на режещите ножове, защото същата е била регулирана за кратък ход.

ЗАБЕЛЕЖКА:

Връзката трябва винаги да се извършва при максимална скорост на двигателя, в противен случай рискът от повреда на колана(ремъка).

В този момент можете да започнете операцията за копаене(обработка) на почвата.

Необходими проверки в случаите, когато Мотокопачката DAC 6500B не тръгва

- Проверете дали маслото в двигателя е на ниво, тъй като двигателят, който захранва вашата мотокопачка, може да бъде оборудван със сензор(датчик) за масло, който прекъсва искрата на запалителната свещ, в случай, че не е на ниво максимум на двигателя;
- проверете дали кранът на горивото е отворен в указаното положение;
- проверете дали в резервоара има гориво и дали е подходящо (да не се използва гориво, различно от посоченото, или на възраст над 2-3 седмици) проверете дали лостът за газта е напълно работещ на максимум;

Поддръжка

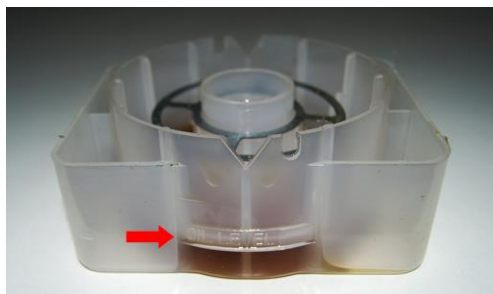

След всяка употреба почиствайте въздушния филтър и сменете маслото във филтърната камера(казанче) с чист на всеки 10 часа

- След всяка употреба почиствайте ножовете за рязане и ги проверявайте
 - След всяка употреба смажете вала, върху който са фиксирани ножовете за рязане
 - Спрете двигателя на всеки 60 минути и го оставете да се охлади за около 20 минути
 - Регулирайте кабелите(жилата), ако забележите, че ножовете не отговарят на команди или не спират натоварването
- Смяна на трансмисионното масло / двигател на всеки 50/25 часа работа или 6 месеца



Монтиране, демонтиране на трансмисионния задвижващ ремък

Това се прави както следва::

- Отстраняване на страничния капак на защитната кутийка
- Отстраняване на колана(ремък) ефективно
- Монтиране на новия трансмисионен колан(ремък)
- Монтиране на защитната капачка

Ако разглобите обтегача на колана(ремъка), той ще бъде монтиран и подравнен след новия колан(ремък), като запази началното положение на регулиращата втулка(обтегач) или я върти на 180 градуса в съответствие със стъпка 7 на монтажния водач, така че ще бъде на една и съща ос да предпазва и да не повреди трансмисионния ремък.

ЗАБЕЛЕЖКА:

Смяна на макарите трябва да бъде направено само в Оторизиран сервис, защото те имат различни закрепвания на винтовете, които ги закрепват.

Ако след дълъг период на работа обтегачът не работи на максимум, ремъкът се плъзга при натоварване,и трябва да се извърши настройка на задвижващия кабел(жило).

Придвижване

Когато искате да управлявате DAC 6500K / DAC 6500 ACC на кратки разстояния, винаги монтирайте задвижващото колело, за да избегнете възможни аварии или повреди на мотокопачката.

Не се придвижвайте с мотокопачка, теглена на колела или теглена от друга машина, тъй като рискувате повреда на двигателя, предаването и т.н

За правилното движение и използване в земята, можете да регулирате височината на рогата(ръкохватки) за допълнителен комфорт.

Опаковане

Опаковането се извършва в затворени кутии за лесно движение(пренасяне). В него ще откриете:

- ръководство за потребителя
- Гаранционен сертификат
- Мотокопачка DAC 6500K / 6500 ACC
- Ключов комплект

Съхранение

- Мотокопачката DAC 6500K / 6500 ACC Motocross трябва да се съхранява на сухо, прахоустойчиво и влагоустойчиво място в помещение с подходящо остъкляване и вентилация.
- Изпразнете цялото гориво както от резервоара, така и от карбуратора.
- Смажете всички активни метални части с мазнина(смазка).
- Оставете маслото в банята(картера) на двигателя по време на съхранение. Сменете маслото на двигателя, ако мотокопачката е бил съхраняван повече от 3 месеца.



Originalno uputstvo za upotrebu
DAC 6500K / DAC 6500ACC
Motokopačica

Uvod

Motokopačice DAC marke su takve mašine za kopanje sa lančanim povezom koje se lako održavaju, i koje i Vi lako možete koristiti.

DAC motokopačice su preporučene za rad na lakoj, obrađenoj zemlji.

Lančane mašine za kopanje su optimizovane pogotovo za lako obradiva, peskovita zemljišta.

Ako želite da obrađujete čvrstije zemljište, molimo Vas da pronađete našu skalu proizvoda u nekom od zvaničnih Ruris predstavništava.

Hvala Vam što ste se odlučili za DAC-ov proizvod!

Informacije i korisnički servis:

Telefon: **0351 820 105**

E-mail: **info@ruris.ro**



Zaštita na radu

Signalizacije



Pažnja! Opasnost!



Pročitajte do kraja uputstvo za upotrebu pre korištenja ovih mašina.



Rukovalac aparata treba da nosi ličnu zaštitu i zaštitu na radu. Prilikom korištenja mašine trebamo da nosimo zaštitne naočare protiv predmeta koje mašina baca ka gore, trebamo da nosimo opremu za zaštitu sluha kao što su izolovani štيتnici za uši od buke kao i zaštitnu kacigu.



Nosite opremu za zaštitu ruku (rukavice).



Nosite opremu za zaštitu nogu (čizme, bakandže).



Opasnost Nož može da lansira opasne elemente prilikom rada.



Držite se podalje od otvorenog izvora vatre. Nemojte pušiti. Nemojte izlupati gorivo. Nemojte točiti gorivo prilikom rada motora ili ako je motor vreo.



Sastavni delovi motokopačice

Motokopačice se sastoje od sledećih delova:

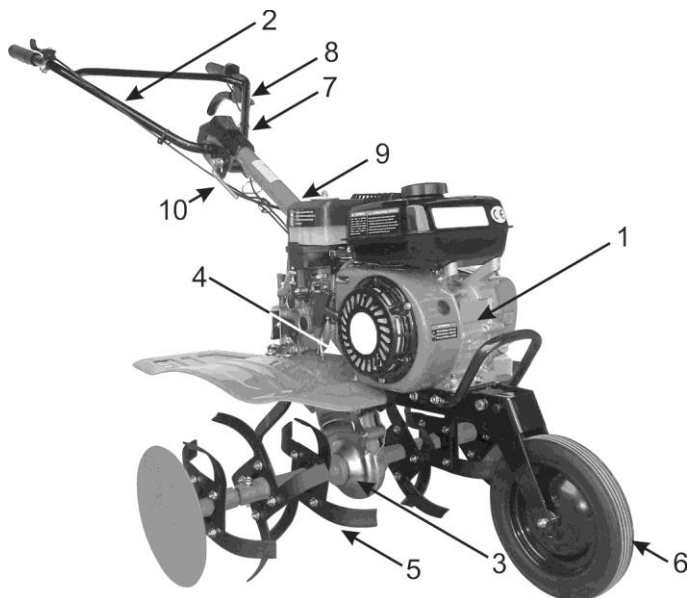

Slika 2

1. motor
2. volan
3. kućište menjačke kutije
4. sredstvo za pokretanje
5. noževi za sečenje
6. pogonski točak
7. podupirač za regulisanje visine
8. kabl kvačila
9. zakačka podupirača
10. gasni kabl



Tehnički opis

- **Pažnja:**
- Motokopačice A DAC 6500K / DAC 6500 ACC nisu fabrički natočene uljem i gorivom. Pre funkcionisanja proverite i natočite ulje na propisan način.
- U motornom prostoru ima ulja ispod minimalnog nivoa ulja, ali je to isključivo u cilju bezbednosti uređaja, a ne za korištenje. Napunite sistem uljem.

Tip:	DAC 6500K / DAC 6500 ACC
Težina (sa noževima)	80 kg
Motor	četvorotaktni
Proizvođač motora	General Engine
Zapremina cilindra	208 cmc
Snaga	7 KS/5.2 kW
Broj obrtaja	Max. 3600 Min. 2000
Potrošnja/h	250 ml/kwh
Gorivo	Bezolovni benzin

Koristiti mašinu za namenjene ciljeve, a to je obrada zemljišta. Svaka druga namena može da bude opasna i može da ošteti uređaj. Nikada nemojte da ga koristite na teritorijama koje su kamenite, sadrže kamenje, u zemljištu mogu da budu postavljeni kablovi ili je zemljište previše tvrdo za obradu.

Zamena ulja u motoru, nakon svakog 25-og sata korištenja. U menjaču nakon svakih 50 sati rada.

Period uhodavanja

1. DAC 6500K / DAC 6500 Motokopačica pod naporom može da radi svega 5 sati, nakon toga trebamo da ispraznimo sredstvo za podmazivanje iz rezervoara i menjačke kutije. Nakon toga napunimo menjačku kutiju sa uljem Ruris G Tronic marke, ili API klasifikacije GL-4 ili za klasu boljim uljem, a motor sa uljem Ruris 4T MAX marke, ili API CI-4/SL klase ili za klasu boljim uljem.
2. DAC 6500K / DAC 6500 ACC Motokopačica radi sa bezolovnim benzinom. Preporučeno je da se pre korištenja gorivo ostavi da se slegne, a zatim ono profiltrira kroz metalno sito.



Sastavljanje

Pre sastavljanja i puštanja u rad trebate da se uverite da je DAC 6500K / DAC 6500 ACC motokopačica adekvatno sastavljena, a za to se trebate pridržavati propisima određenim u ovom priručniku, jer se samo tada stvara mogućnost samostalnog puštanja u rad.

Punjenje nivoa motornog ulja

Pre pokretanja motora natočite u motor Ruris-4t Max ili CI-4/SL ulje više klase. Motokopačica ne sadrži u sebi ulje u trenutku prodaje.

Kapacitet ulja motora: 0,6L

NAPOMENA:

Nemojte koristiti uređaj u rikvercu u funkciji kopanja na staze duže od 10 metara.

Često proveravajte nivo ulja, na način što ćete odvrtiti poklopac za ulje na motoru, i uverite se da li nivo ulja dostiže adekvatan nivo prema oznakama. Tu kontrolu je preporučeno izvršiti kada je kopačica u horizontalnom položaju.



2. Slika

NAPOMENA:

Pre svakog pokretanja četiri puta lagano i nežno izvucite pokretni kabl (a taster za uključivanje treba da bude na OFF poziciji) kako bi u motoru ulje doseglo svaki cilindar i ventil. U suprotnom, sa naglim pokretanjem motora rizikujete sagorevanje cilindara i oštećenje sredstva.

1. Točenje goriva

Koristite kvalitetno gorivo sa zvanične benzinske pumpe.

Natočite bezolovni benzin najboljeg kvaliteta, pomoću metalnog levka, i to uradite na dobro provetреноj teritoriji daleko od svakog eventualnog izvora vatre ili varnice, koje može da dovede do povreda.

NAPOMENA:

Nemojte točiti pored zemljišta ili u blizini useva, jer na taj način ozbiljno možete da zagadite okolinu.



Punjenje kvačila uljem

Kapacitet menjačke kutije je 1500 ml.

Koristite ulje Ruris G-Tronic marke ili API: GL-4 ulje viših klasa.

Maksimalni nivo pokretačkog mehanizma se nalazi na dnu otvora za točenje sa desne strane pokretačkog mehanizma (3.1-Slika)

Kopačica se dostavlja bez ulja.

Zamena ulja u menjačkoj kutiji treba da se izvrši nakon svakog 50-og sata rada.



3.1 Slika



3.2 Slika

Nivel maxim: Maksimalni nivo

Buson golire: Otvor za pražnjenje ulja

PUŠTANJE U RAD

Zabranjeno je motor pustiti da radi u praznom hodu duže od 5 minuta jer to dovodi do oštećenja kaiša menjača.

Motor vaše kopačice je već fabrički uhodan, te nije potrebno dodatno da se uhodava.

Pre nego što pustite u rad kopačicu tipa DAC 6500K / DAC 6500 ACC trebate da se uverite da su sledeći uslovi obezbeđeni:

- Napunite uljani rezervoar koji se nalazi na vazдушnom filteru čistim motornim uljem do oznake maksimuma,
- U blizini od pet metara kopačice nema drugih osoba koje mogu da nalete na nju,
- Kopačica DAC 6500K / DAC 6500 ACC je postavljena horizontalno,
- Prvi točak je namontiran i izdiže se iz zemljišta
- Motor je u potpunosti napunjen uljem
- Menjačka kutija je maksimalno napunjena uljem,
- U motoru ima najmanje pola litre goriva,
- Sečiva su fiksirana vijcima, i ako su i transportni točkovi namontirani, trebaju da se fiksiraju vijcima za fiksiranje, a pritisak u gumenom točku treba da bude 1,5-2 bara. Svaki vijak treba adekvatno da se zategne.



Pokretanje motora

- Uključite šok-ručku motora,

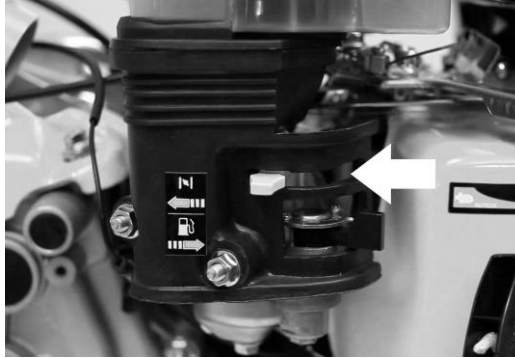

4. Slika

Uključite ručicu ventila za benzin, u smeru kao na slici

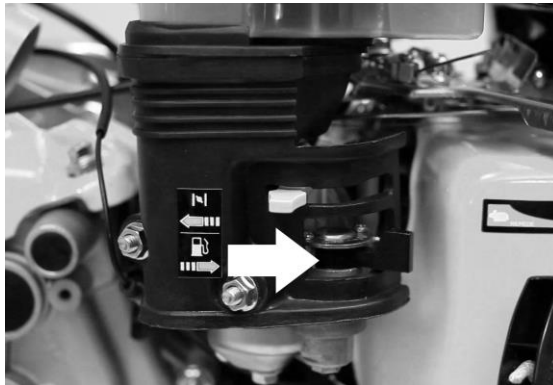

5. slika:

- Povucite četiri puta nežno pokretni kabl, ali nemojte to uraditi grubo. Ovaj blagi pokret pomaže u tome da se motorno ulje razlije u delovima motora, ventilima, itd.
- Povucite gasnu ručku do maksimuma, kao na slici broj 6.
- Uključite dugme za uključivanje-isključivanje kako biste pokrenuli uređaj.



6. slika

- Nakon što ste odradili četiri puta blago povlačenje, sada možete snažnije povući starter konopac.
- Od početka pokretanja motora počnite polako da namestite šok ručku u osnovno stanje, pazeći na to da motor ne stane, odnosno isključivo ako motor već ravnomerno radi.
- Smanjite broj obrtaja motora na pola, a levom rukom polako pokrenite funkciju kopanja sa pokretanjem ručke, te će noževi za kopanje početi da se okreću.

PAŽNJA:

Ako naglo otpustite pokretnu ručku rotirajućih noževa, nagli pokret može da dovede do toga da oni stanu.

Ako se stalno čuje interferentni šum iz osovinskog prekidača, ili ako se kopačica ne pokrene, proverite pokretni kabl sečiva, jer su oni podešeni previše kratko.

NAPOMENA:

Osovinski prekidač mora uvek da bude izveden pri maksimalnom obrtaju, u obrnutom slučaju možemo da izazovemo oštećenje kaiša.

U ovom stanju je već sve spremno da se započne sa obradom zemljišta.

Potrebne mere, ako se DAC 6500K / DAC 6500 ACC motokopačica ne pokreće:

- Proverite da li je motorno ulje na adekvatnom nivou, jer motorno sredstvo koje okreće noževe vaše kopačice može da sadrži i jednim sigurnosnim senzorom za ulje, što može da prekine paljenje iskre na utikaču svećice, ako motor nije na maksimalnom nivou;
- Proverite da li je ventil za gorivo adekvatno odvrnut.
- Proverite da li ima goriva u rezervoaru i da li je ono adekvatnog tipa. Nemojte koristiti gorivo druge vrste od propisanog, ili starije gorivo od 2-3 nedelje.



- Proverite da li je gasna ručka okrenuta na maksimum.
- Proverite da li je šok ručka već zatvorena, vraćena na osnovnu poziciju.
- Proverite da li je vazdušni filter previše zaprljan, da nije slučajno začepljen od zaprljanja.
- Zamenite svećicu.

ODRŽAVANJE

- Nakon svakog korištenja očistite vazdušni filter i zamenite ulje u rezervoaru za ulje, koristeći čisto ulje, a drugi na svakih 10 sati.

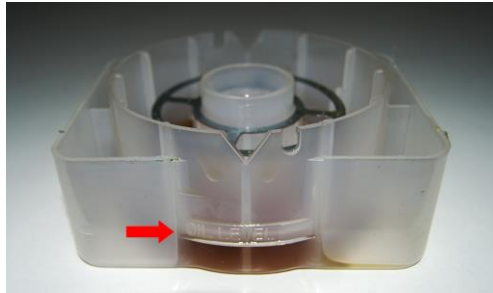

- Nakon svakog korištenja očistite rotirajuće noževe i proverite ih
- Nakon svakog korištenja podmažite vreteno za koje su rotirajući noževi fiksirani
- Nakon svakih 60 minuta korištenja zaustavite motor i ostavite da pauzira najmanje 20 minuta.
- Podesite žičane uzadi ako primetite da rotirajući noževi ne reaguju adekvatno na upravljanje, ili bez razloga zastaju prilikom rada.
- Zamenite motorno ulje i ulje menjača nakon 50/25 sati rada, ili u slučaju izostanka navedenog svakih 6 meseci.

Instaliranje i demontaža prenosnog kaiša

To se radi na sledeći način:

- Odstranite bočnu ploču zaštitnog poklopca
- Efikasno odstranjenje kaiša
- Postavljanje novog kaiša
- Vraćanje bočne ploče zaštitnog poklopca

Ako opustite zategnutost kaiša, prilikom montiranja novog kaiša trebate da pazite na to da se kaiš vrati na istu poziciju, okrenite ga za 180 stepeni kako biste se uverili da se obrće u istom uglu. Na taj način možete prevenirati svoj kaiš od oštećenja.

Napomena:

Vijak (spiralni točak na kojem se kreće kaiš) smeju da zamene samo u zvaničnom ovlašćenom servisu, jer poseduju jedinstvene ureze i dimenzije. U suprotnom će se uništiti kaiš menjača.

Ako nakon dugotrajnog rada zatezač ne radi u potpunosti, a remen se kliže, potrebno je ponovo podesiti pokretni kabl.



PROMENA POLOŽAJA

Ako želite da transportujete a DAC 6500K / DAC 6500 ACC motokopačice na male razdaljine, uvek imajte namontirani transportni točak, na taj način prevenišući oštećenje kopačice.

Nemojte šlepati kopačicu ili njom nemojte šlepati druga motorna vozila, jer možete da oštetite uređaj.

U cilju udobnog rukovanja i vožnje možete podesiti visinu volana.

Ambalaža

Ambalaža kopačice je izvedena zatvorenom kartonskom oblogom u cilju lakšeg transporta.

Sadržaj istog je:

- Uputstvo za upotrebu
- Garantni list
- DAC 6500K / 6500 ACC motokopačica
- Paket alata

Skladištenje

- DAC 6500K / 6500 ACC motokopačica treba da se skladišti na suvom, zatvorenom mestu bez vlage, odnosno u prostoriji sa bezbednim krovom, prozorima i adekvatnom ventilacijom.
- Ispraznite u potpunosti gorivo iz rezervoara i karburatora.
- Podmažite aktivne metalne delove.
- Ostavite ulje u rezervoaru za ulje za vreme skladištenja.
- Ako nakon 3 meseca skladištenja ponovo koristite motokopačicu, zamenite ulje u uređaju.



16. DECLARATIONS OF CONFORMITY

EC DECLARATION OF CONFORMITY

**Manufacturer:** SC RURIS IMPEX SRL

Calea Severinului, nr. 10, Bl. 317b, Craiova, Dolj, Romania

Tel. 0351 464 632, www.ruris.ro, info@ruris.ro

Authorised representative: eng. Stroe Marius Catalin - Director General

Authorised person for the technical file: eng. Florea Nicolae - Production Design Director

Product description:The **TILLER** is for soil tillage and other work, with the tiller being the basic power component and the rotary tiller with knives and other accessories the actual working equipment.

Product: TILLER

Product serial number: xx DAC6500K 0001 to xx DAC6500K 9999 (where xx represents the last two digits of the year of manufacture)

Type: 6500K **Model:** DAC**Engine:** thermal, unleaded gasoline, 4-stroke**Power:** 7 hp**No. of gears:** 2 forward + 1 reverse**Max no. of knives:** 24 (4x6) sets**Transmission:** sprocket/belt chain**Working width:** max 83 cm

*We, SC RURIS IMPEX SRL Craiova, manufacturer, in accordance with H.G. 1029/2008 - on the conditions for placing machinery on the market, **Directive 2006/42/EC - machinery; safety and security requirements, Standard EN ISO 12100:2010 - Machinery. Safety, EU Regulation 2016/1628 (amended by EU Regulation 2018/989) - laying down measures to limit gaseous and particulate pollutant emissions from engines and H.G. 467/2018 on measures for the implementation of the above-mentioned Regulation, we have carried out the attestation of conformity of the product with the specified standards and declare that it complies with the main safety and security requirements.***

I, Stroe Catalin, the manufacturer's representative, declare on my own responsibility that the product complies with the following European standards and directives:

SR EN ISO 12100:2011/ EN ISO 12100:2010 - Safety of machinery. Basic concepts, general design principles. Basic terminology, methodology. Technical principles

SR EN ISO 3744:2011/ EN ISO 3744:2011 - Forestry and gardening machinery. Noise test code for machines equipped with an internal combustion engine.

SR EN ISO 11850:2012/ EN ISO 11850:2011 - Forestry machinery. General safety requirements

SR EN ISO 4254-1:2016/ EN ISO 4254-1:2015 - Agricultural machinery. Safety of machinery.

SR EN ISO 4254-5:2018/ EN ISO 4254-5:2018 - Agricultural machinery. Safety. Part 5: Soil-working machines with powered tools

SR EN 709+A4:2010/AC:2013 Agricultural and forestry machinery. Cultivators fitted with mounted rotary cultivators, brush cutters and wheel-mounted rotary cultivators. Safety



SR EN 14930+A1:2009/ EN ISO 14930:2007+A1:2009 - Agricultural and forestry machinery and gardening machinery. Hand-held and pedestrian-controlled machinery. Determination of the risk of contact with hot surfaces

SR EN 12733:2019/ EN 12733:2018 - Agricultural and forestry machinery. Pedestrian-controlled tractors. Safety

SR EN 1679-1+A1:2011/ EN 1679-1:1998+A1:2011- Reciprocating internal combustion engines. Safety. Part 1: Compression ignition engines

SR EN 11850:2012/A1:2016/ EN ISO 11850:2011/A1:2016 - Forestry machinery. Self-propelled machinery. Safety requirements

EN 14982:2009 - Agricultural and forestry machinery. Electromagnetic compatibility.

SR EN 55014-1:2017; 55014-2:2015 - Electromagnetic compatibility

SR EN 61000-3-2/2014; 61000-3-3/2013 - Electromagnetic compatibility

- **Directive 2000/14/EC** (amended by Directive 2005/88/EC) - Outdoor noise emissions
- **Directive 2006/42/EC** - on machinery - placing on the market of machinery
- **Directive 2014/30/EU** - on electromagnetic compatibility (HG 487/2016 on electromagnetic compatibility, updated 2019);
- **EU Regulation 2016/1628 (amended by EU Regulation 2018/989)** - setting measures to limit gaseous and particulate pollutant emissions from engines

Other Standards or specifications used:

- **SR EN ISO 9001** - Quality Management System
- **SR EN ISO 14001** - Environmental Management System
- **SR ISO 45001:2018** - Occupational Health and Safety Management System.

MARKING AND LABELLING OF ENGINES

Spark ignition gasoline engines type-approved and used on RURIS equipment and machines according to **EU Regulation 2016/1628 (amended by EU Regulation 2018/989)** and HG 467/2018 are marked with:

- Brand and manufacturer's name: C.H.P.T. CO LTD.

- Type: H210

- Type approval number obtained by the specialist manufacturer:

e13*2016/1628*2016/1628SRA2/P*0303*00;

- Engine identification number - unique number.

- Concept General Engine

Note: the technical documentation is owned by the manufacturer.

Note: This declaration is in conformity with the original.

Validity: 10 years from the date of approval.

Place and date of issue: **Craiova, 25.06.2021**

Year of application of the CE marking: **2021**

Registration No: **800/25.06.2021**

Authorized person and signature:

Ing. Stroe Marius Catalin

Director General of

SC RURIS IMPEX SRL



EC DECLARATION OF CONFORMITY

Manufacturer: SC RURIS IMPEX SRL

Calea Severinului, nr. 10, Bl. 317b, Craiova, Dolj, Romania

Tel. 0351 464 632, www.ruris.ro, info@ruris.ro

Authorised representative: eng. Stroe Marius Catalin - Director General

Authorised person for the technical file: eng. Florea Nicolae - Production Design Director

Product description:The **TILLER** is used for soil tillage and other work, with the tiller being the basic power component and the rotary tiller with knives and other accessories the actual working equipment.

Product serial number: xx DAC6500K 0001 to xx DAC6500K 9999 (where xx represents the last two digits of the year of manufacture)

Type: 6500K **Model:** DAC

Engine: thermal, unleaded gasoline, 4-stroke

Power: 7 hp

No. of gears: 2 forward + 1 reverse

Max no. of knives: 24 (4x6) sets

Transmission: sprocket/belt chain

Working width: max 83 cm

Sound power level (idle): 84 **dB(A)**

Sound power level: 84 **dB(A)**

The **sound power level** is certified by I.N.M.A Bucharest by test report no. 2/05.09.2019 in accordance with the provisions of Directive 2000/14/EC as amended by Directive 2005/88/EC and SR EN ISO 3744:2011.

We, SC RURIS IMPEX SRL Craiova as manufacturer, in accordance with Directive 2000/14/EC (amended by Directive 2005/88/EC), H.G. 1756/2006 - on the limitation of noise emissions in the environment from equipment for use outdoors, have verified and certified the conformity of the product with the specified standards and declare that it complies with the main requirements.

I, Stroe Catalin, the manufacturer's representative, declare on my own responsibility that the product complies with the following European standards and directives:

- **Directive 2000/14/EC (amended by Directive 2005/88/EC)** - Outdoor noise emissions
- **SR EN ISO 3744:2011** - Acoustics. Determination of sound power levels emitted by noise sources using sound pressure
- **Directive 2006/42/EC** - on machinery - placing on the market of machinery
- **Directive 2014/30/EU** on electromagnetic compatibility (HG 487/2016 on electromagnetic compatibility, updated 2019);
- **EU Regulation 2016/1628** (amended by EU Regulation 2018/989) - setting measures to limit gaseous and particulate pollutant emissions from engines

Other Standards or specifications used:

- **SR EN ISO 9001** - Quality Management System
- **SR EN ISO 14001** - Environmental Management System
- **SR ISO 45001:2018** - Occupational Health and Safety Management System.

Note: the technical documentation is owned by the manufacturer.

Note: This declaration is in conformity with the original.

Validity: 10 years from the date of approval.

Place and date of issue: **Craiova, 25.06.2021**



EN

Year of application of the CE marking: **2021**

Registration No: **801/25.06.2021**

Authorized person and signature:

Ing. Stroe Marius Catalin
Director General of
SC RURIS IMPEX SRL

EC DECLARATION OF CONFORMITY

Manufacturer: SC RURIS IMPEX SRL

Calea Severinului, nr. 10, Bl. 317b, Craiova, Dolj, Romania

Tel. 0351 464 632, www.ruris.ro, info@ruris.ro

Authorised representative: eng. Stroe Marius Catalin - Director General

Authorised person for the technical file: eng. Florea Nicolae - Production Design Director

Product description:The **TILLER** is for soil tillage and other work, with the tiller being the basic power component and the rotary tiller with knives and other accessories the actual working equipment.

Product: TILLER

Product serial number: xx DAC6500ACC 0001 to xx DAC6500ACC 9999 (where xx represents the last two digits of the year of manufacture)

Type: 6500ACC1/ ACC2 **Model:** DAC

Engine: thermal, unleaded gasoline, 4-stroke

No. of gears: 2 forward + 1 reverse

Transmission: sprocket/belt chain

Power: 7 hp

Max no. of knives: 24 (4x6) sets

Working width: max 83 cm

*We, SC RURIS IMPEX SRL Craiova, manufacturer, in accordance with H.G. 1029/2008 - on the conditions for placing machinery on the market, **Directive 2006/42/EC - machinery; safety and security requirements**, Standard EN ISO 12100:2010 - Machinery. Safety, **EU Regulation 2016/1628 (amended by EU Regulation 2018/989) - laying down measures to limit gaseous and particulate pollutant emissions from engines** and H.G. 467/2018 on measures for the implementation of the above-mentioned Regulation, we have carried out the attestation of conformity of the product with the specified standards and declare that it complies with the main safety and security requirements.*

I, Stroe Catalin, the manufacturer's representative, declare on my own responsibility that the product complies with the following European standards and directives:



SR EN ISO 12100:2011/ EN ISO 12100:2010 - Safety of machinery. Basic concepts, general design principles. Basic terminology, methodology. Technical principles

SR EN ISO 3744:2011/ EN ISO 3744:2011 - Forestry and gardening machinery. Noise test code for machines equipped with an internal combustion engine.

SR EN ISO 11850:2012/ EN ISO 11850:2011 - Forestry machinery. General safety requirements

SR EN ISO 4254-1:2016/ EN ISO 4254-1:2015 - Agricultural machinery. Safety of machinery.

SR EN ISO 4254-5:2018/ EN ISO 4254-5:2018 - Agricultural machinery. Safety. Part 5: Soil-working machines with powered tools

SR EN 709+A4:2010/AC:2013 Agricultural and forestry machinery. Cultivators fitted with mounted rotary cultivators, brush cutters and wheel-mounted rotary cultivators. Safety

SR EN 14930+A1:2009/ EN ISO 14930:2007+A1:2009 - Agricultural and forestry machinery and gardening machinery. Hand-held and pedestrian-controlled machinery. Determination of the risk of contact with hot surfaces

SR EN 12733:2019/ EN 12733:2018 - Agricultural and forestry machinery. Pedestrian-controlled tractors. Safety

SR EN 1679-1+A1:2011/ EN 1679-1:1998+A1:2011- Reciprocating internal combustion engines. Safety. Part 1: Compression ignition engines

SR EN 11850:2012/A1:2016/ EN ISO 11850:2011/A1:2016 - Forestry machinery. Self-propelled machinery. Safety requirements

EN 14982:2009 - Agricultural and forestry machinery. Electromagnetic compatibility.

SR EN 55014-1:2017; 55014-2:2015 - Electromagnetic compatibility

SR EN 61000-3-2/2014; 61000-3-3/2013 - Electromagnetic compatibility

- **Directive 2000/14/EC** (amended by Directive 2005/88/EC) - Outdoor noise emissions
- **Directive 2006/42/EC** - on machinery - placing on the market of machinery
- **Directive 2014/30/EU** - on electromagnetic compatibility (HG 487/2016 on electromagnetic compatibility, updated 2019);
- **EU Regulation 2016/1628 (amended by EU Regulation 2018/989)** - setting measures to limit gaseous and particulate pollutant emissions from engines

Other Standards or specifications used:

- **SR EN ISO 9001** - Quality Management System
- **SR EN ISO 14001** - Environmental Management System
- **SR ISO 45001:2018** - Occupational Health and Safety Management System.

MARKING AND LABELLING OF ENGINES

Spark ignition gasoline engines type-approved and used on RURIS equipment and machines according to **EU Regulation 2016/1628 (amended by EU Regulation 2018/989)** and HG 467/2018 are marked with:

- Brand and manufacturer's name: C.H.P.T. CO LTD.
- Type: H210
- Type approval number obtained by the specialist manufacturer:

e13*2016/1628*2016/1628SRA2/P*0303*00;

- Engine identification number - unique number.



- Concept General Engine

Note: the technical documentation is owned by the manufacturer.

Note: This declaration is in conformity with the original.

Validity: 10 years from the date of approval.

Place and date of issue: **Craiova, 25.06.2021**

Year of application of the CE marking: **2021**

Registration No: **798/25.06.2021**

Authorized person and signature:

Ing. Stroe Marius Catalin
Director General of
SC RURIS IMPEX SRL

EC DECLARATION OF CONFORMITY

Manufacturer: SC RURIS IMPEX SRL

Calea Severinului, nr. 10, Bl. 317b, Craiova, Dolj, Romania

Tel. 0351 464 632, www.ruris.ro, info@ruris.ro

Authorised representative: eng. Stroe Marius Catalin - Director General

Authorised person for the technical file: eng. Florea Nicolae - Production Design Director

Product description:The **TILLER** is used for soil tillage and other work, with the tiller being the basic power component and the rotary cutter with knives and other accessories the actual working equipment.

Product serial number: xx DAC6500ACC 0001 to xx DAC6500ACC 9999 (where xx represents the last two digits of the year of manufacture)

Type: 6500ACC1/ ACC2 **Model:** DAC

Engine: thermal, unleaded gasoline, 4-stroke

Power: 7 hp

No. of gears: 2 forward + 1 reverse

Max no. of knives: 24 (4x6) sets

Transmission: sprocket/belt chain

Working width: max 83 cm

Sound power level (idle): 84 dB(A)

Sound power level: 84 dB(A)

The **sound power level** is certified by I.N.M.A Bucharest by test report no. 2/05.09.2019 in accordance with the provisions of Directive 2000/14/EC as amended by Directive 2005/88/EC and SR EN ISO 3744:2011.

We, SC RURIS IMPEX SRL Craiova as manufacturer, in accordance with Directive 2000/14/EC (amended by Directive 2005/88/EC), H.G. 1756/2006 - on the limitation of noise emissions in the environment from equipment for use outdoors, have verified and certified the conformity of the product with the specified standards and declare that it complies with the main requirements.



I, Stroe Catalin, the manufacturer's representative, declare on my own responsibility that the product complies with the following European standards and directives:

- **Directive 2000/14/EC (amended by Directive 2005/88/EC)** - Outdoor noise emissions
- **SR EN ISO 3744:2011** - Acoustics. Determination of sound power levels emitted by noise sources using sound pressure
- **Directive 2006/42/EC** - on machinery - placing on the market of machinery
- **Directive 2014/30/EU** on electromagnetic compatibility (HG 487/2016 on electromagnetic compatibility, updated 2019);
- **EU Regulation 2016/1628** (amended by EU Regulation 2018/989) - setting measures to limit gaseous and particulate pollutant emissions from engines

Other Standards or specifications used:

- **SR EN ISO 9001** - Quality Management System
- **SR EN ISO 14001** - Environmental Management System
- **SR ISO 45001:2018** - Occupational Health and Safety Management System.

Note: the technical documentation is owned by the manufacturer.

Note: This declaration is in conformity with the original.

Validity: 10 years from the date of approval.

Place and date of issue: **Craiova, 25.06.2021**

Year of application of the CE marking: **2021**

Registration No: **799/25.06.2021**

Authorized person and signature:

Ing. Stroe Marius Catalin
Director General of
SC RURIS IMPEX SRL