

LOUNGE CHAIR

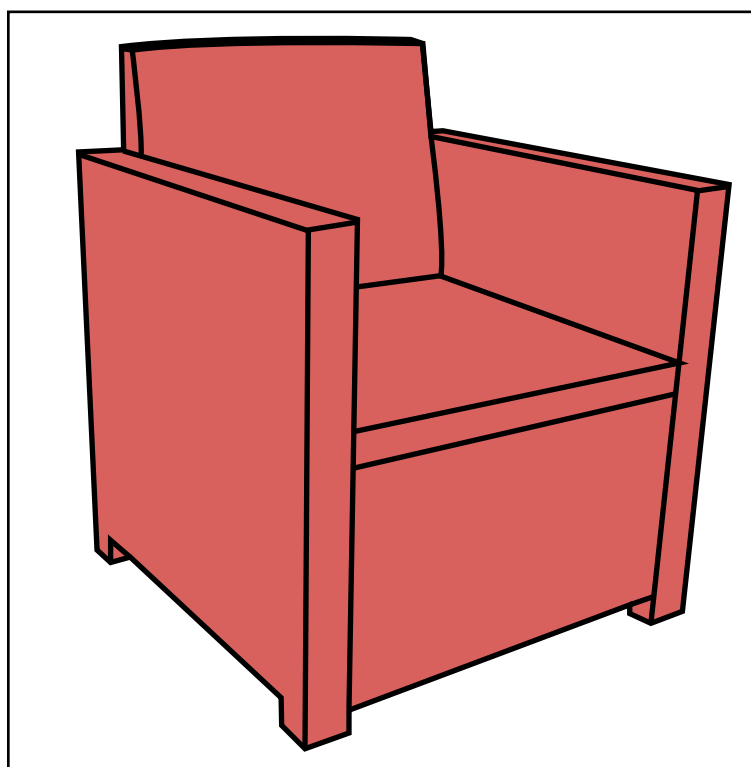

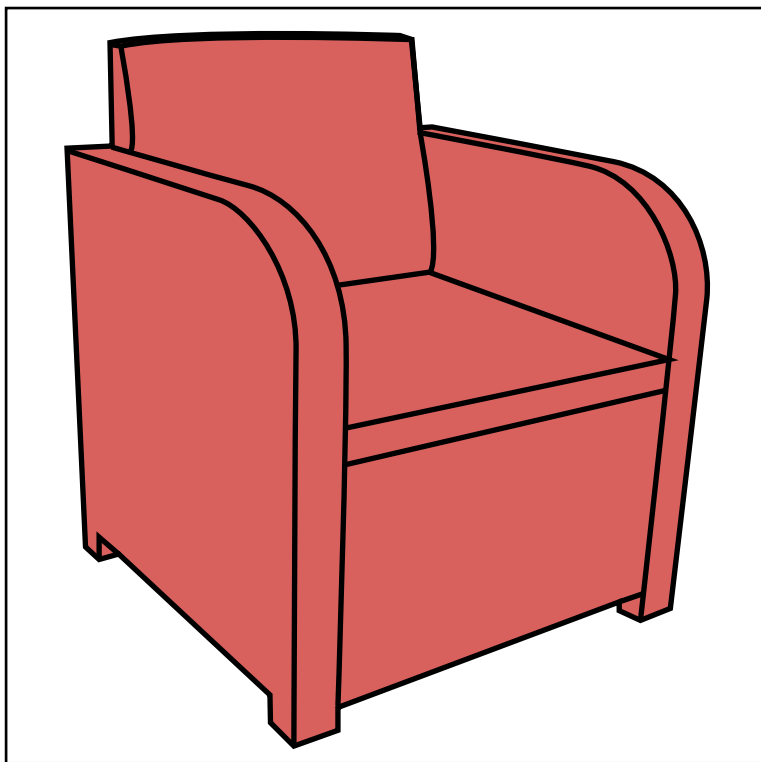

NEN 581

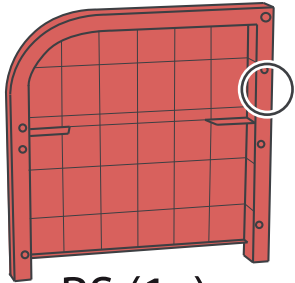
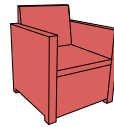
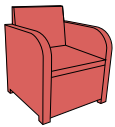
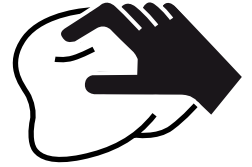

RS (1x)

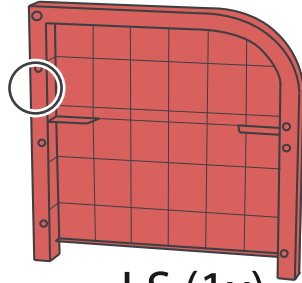

LS (1x)

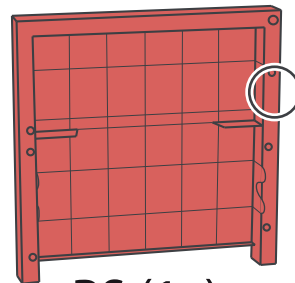

RS (1x)

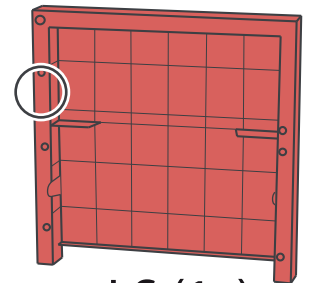

LS (1x)

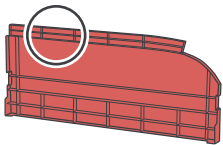

SCR (1x)

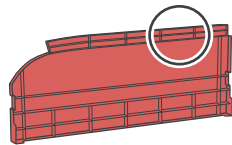

SCL (1x)

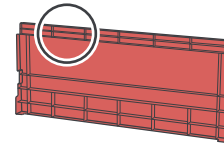

SC (2x)

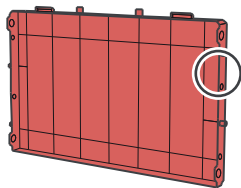

F1 (1x)

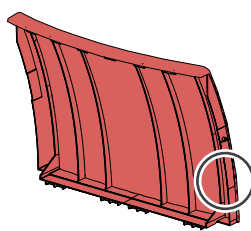

BC (1x)

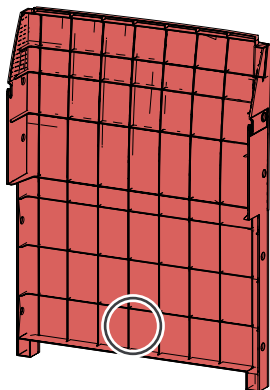

B (1x)

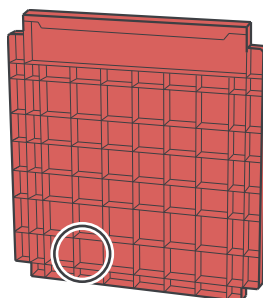

S1 (1x)

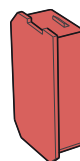

NA (2x)

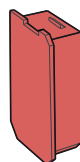

NB (2x)

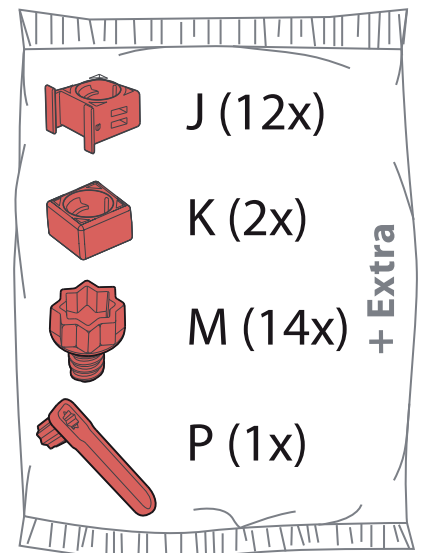

J (12x)

K (2x)

M (14x)

P (1x)

+ Extra

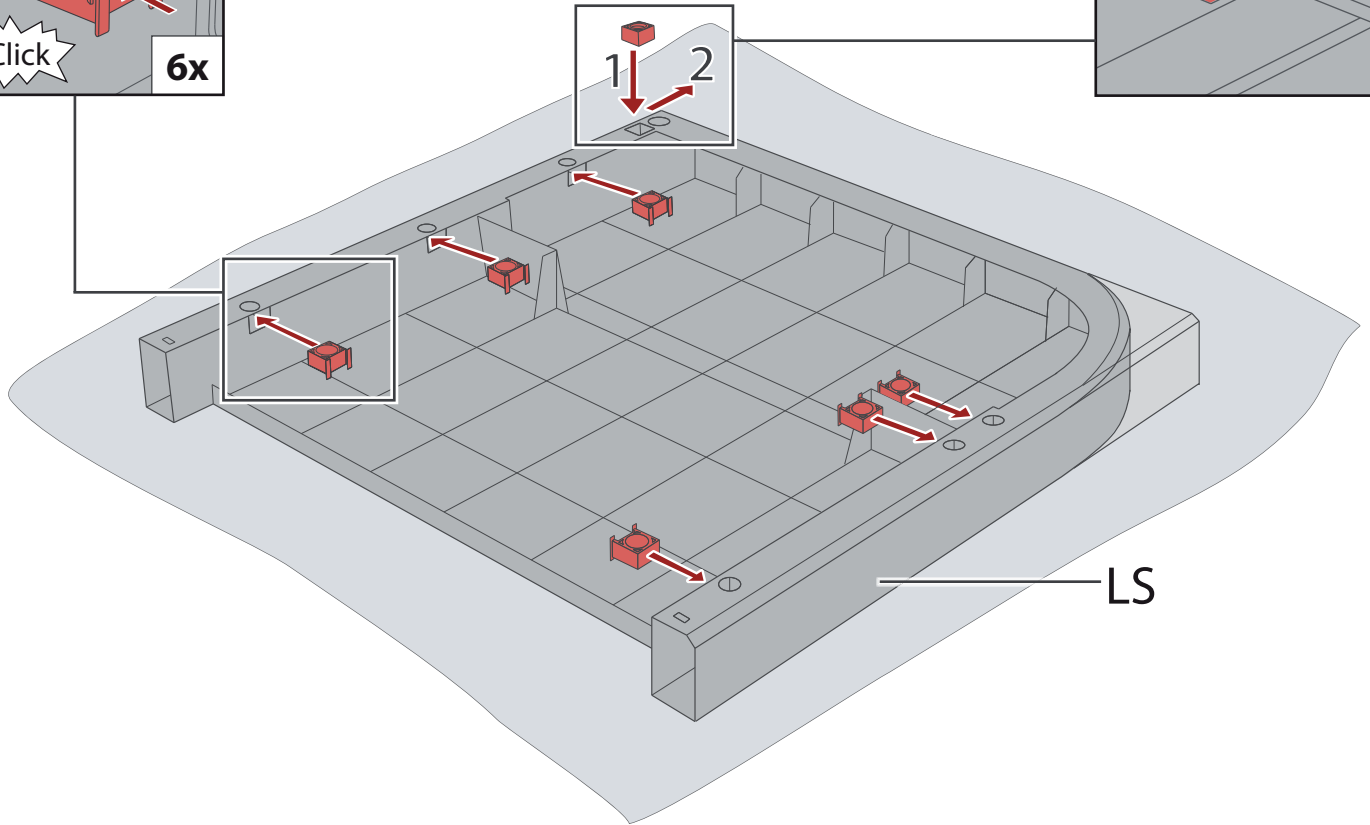
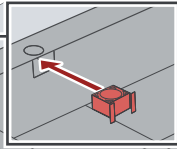
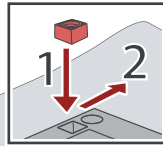
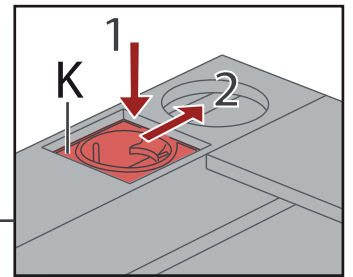
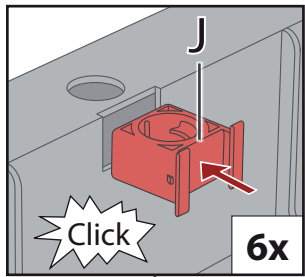

1

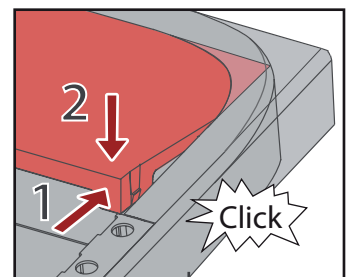

SC/SCL

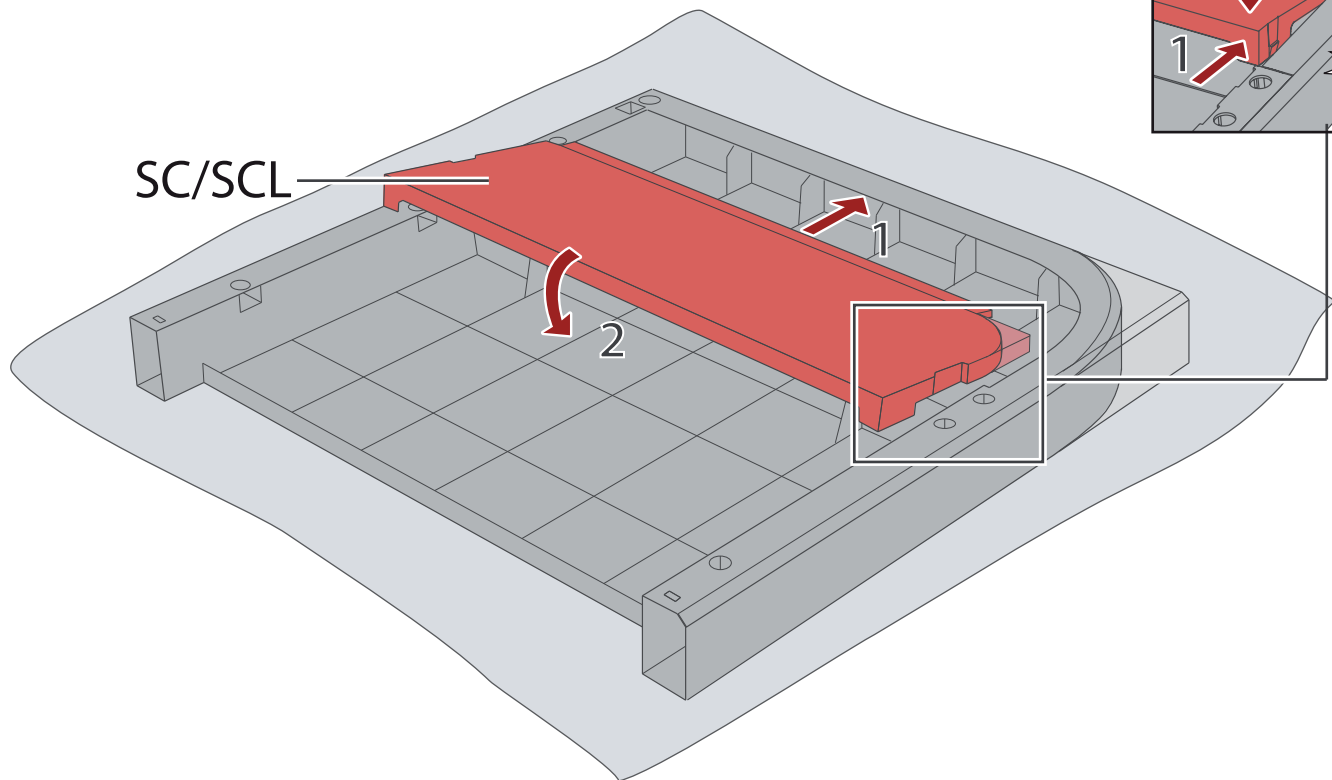

2

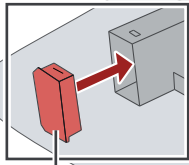
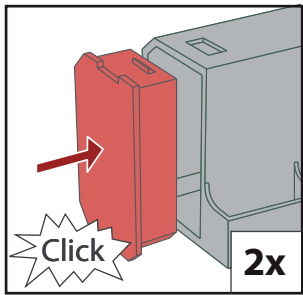

NA



NB

3

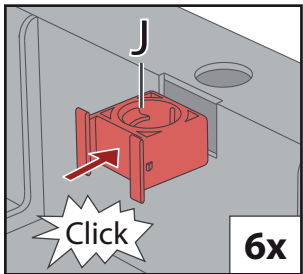

Click

6x

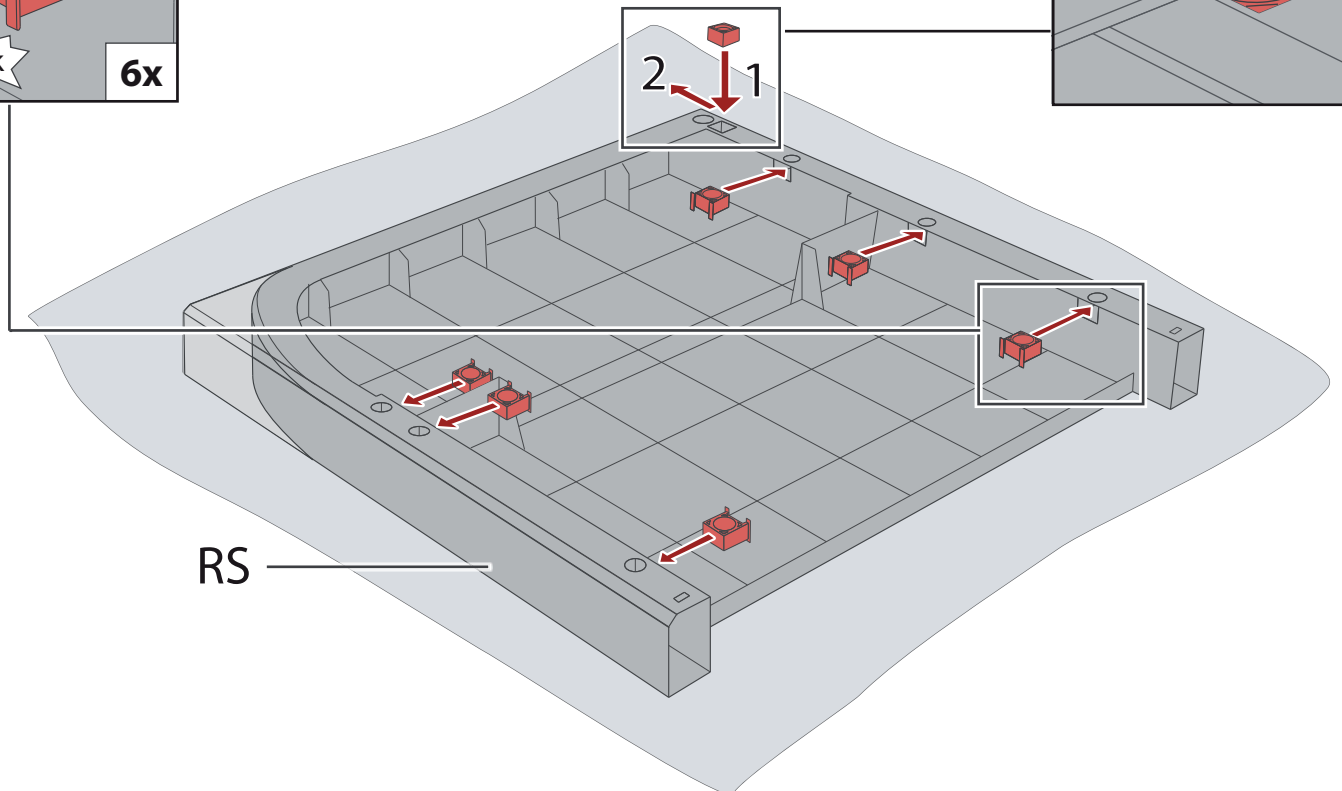

RS

4

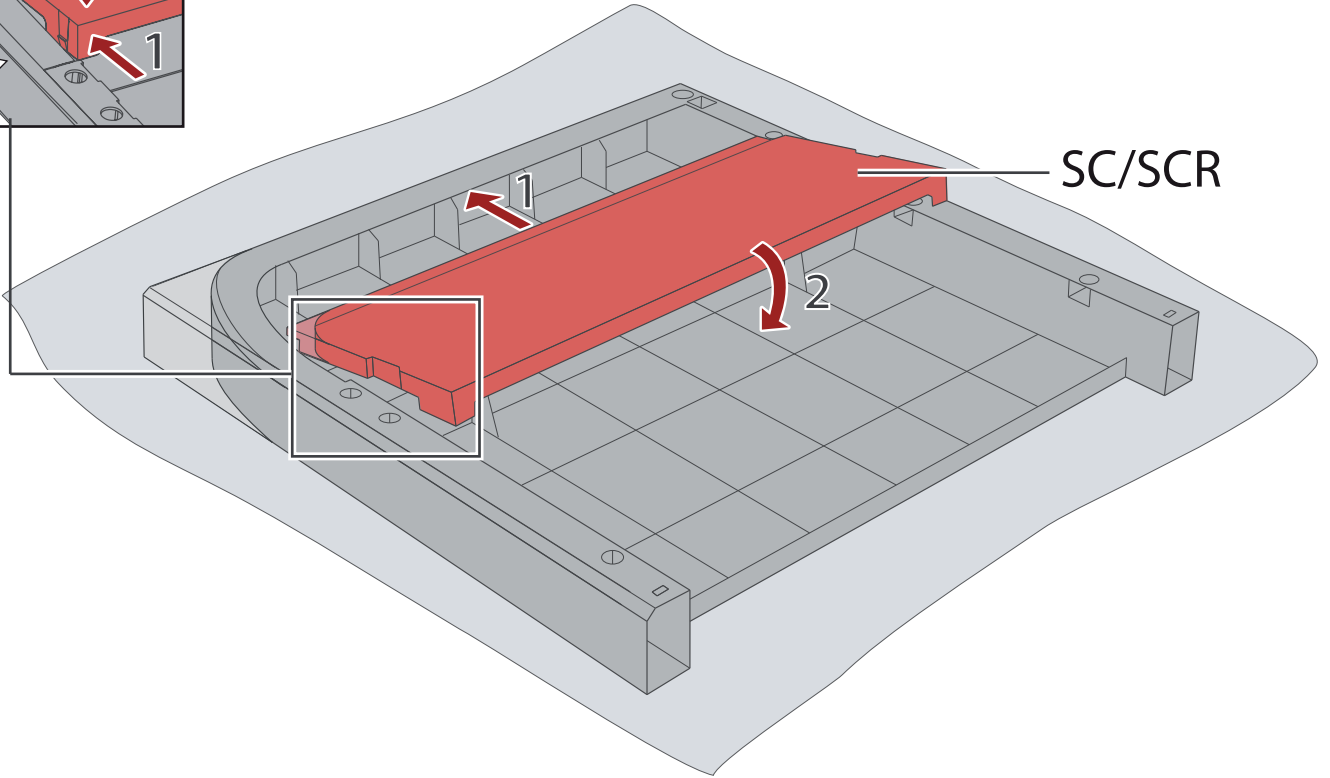
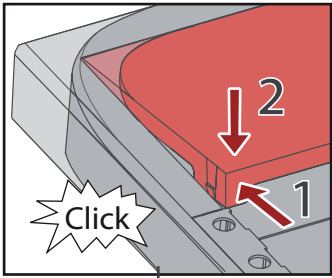

5

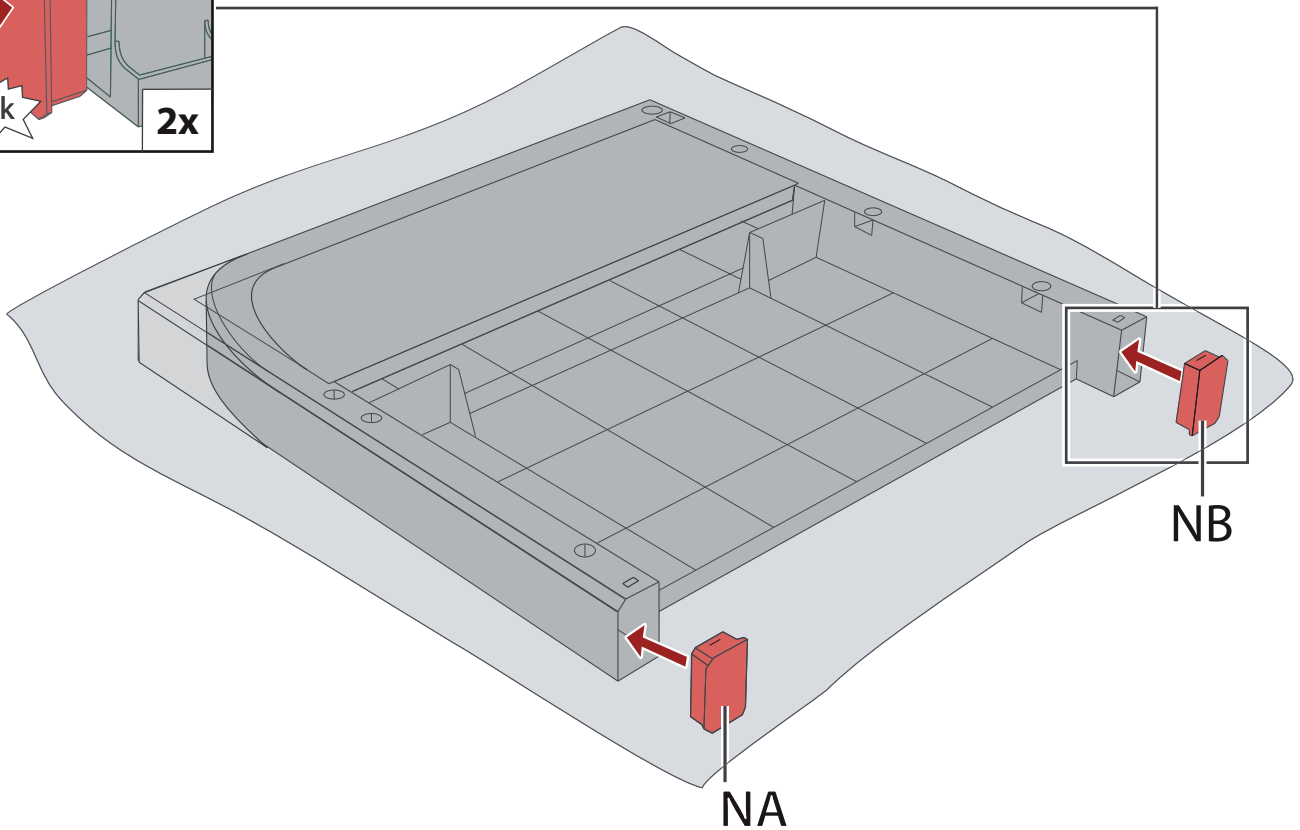
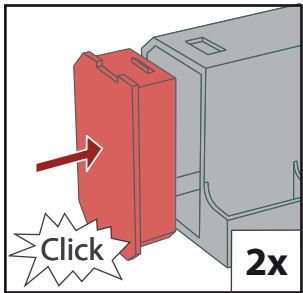

6

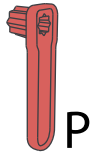
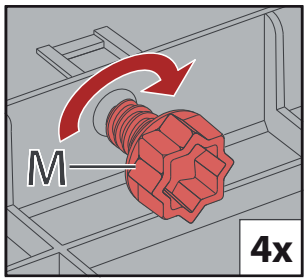

P

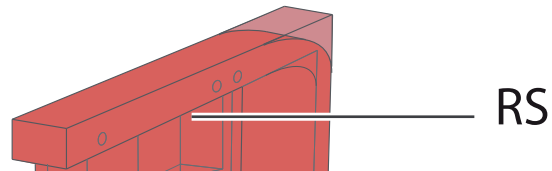

RS

B1

1

2

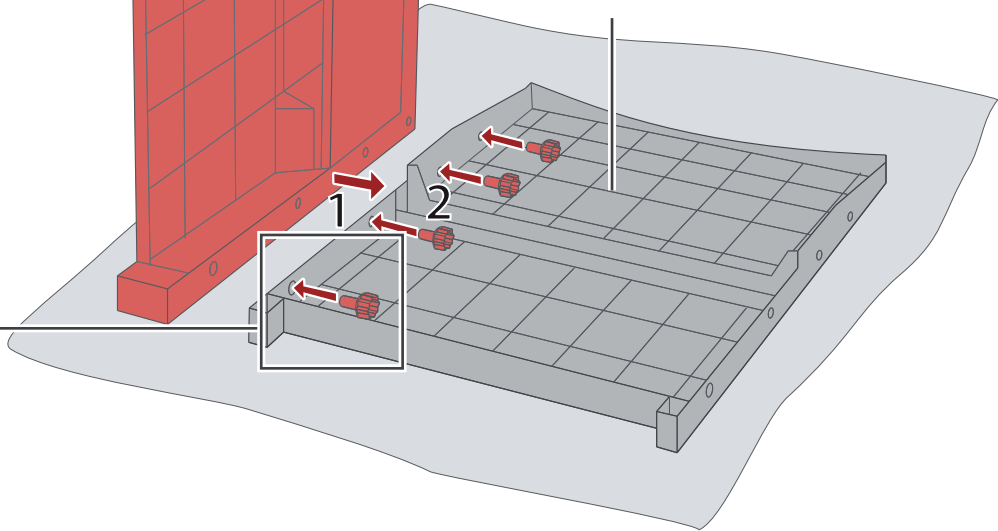
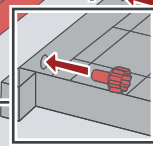

7

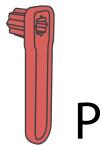
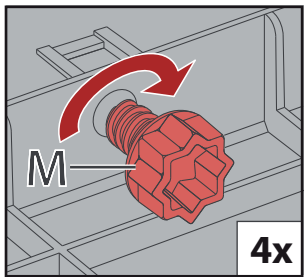

P

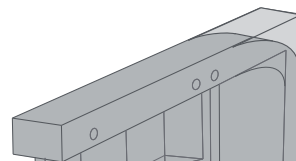

LS

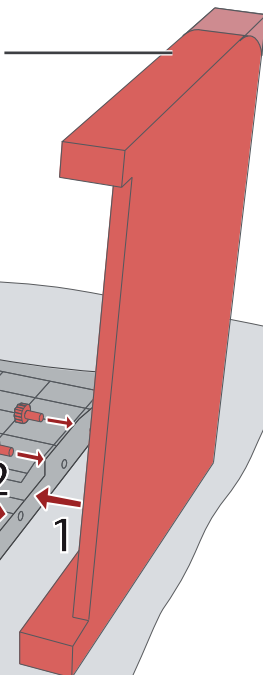

2

1

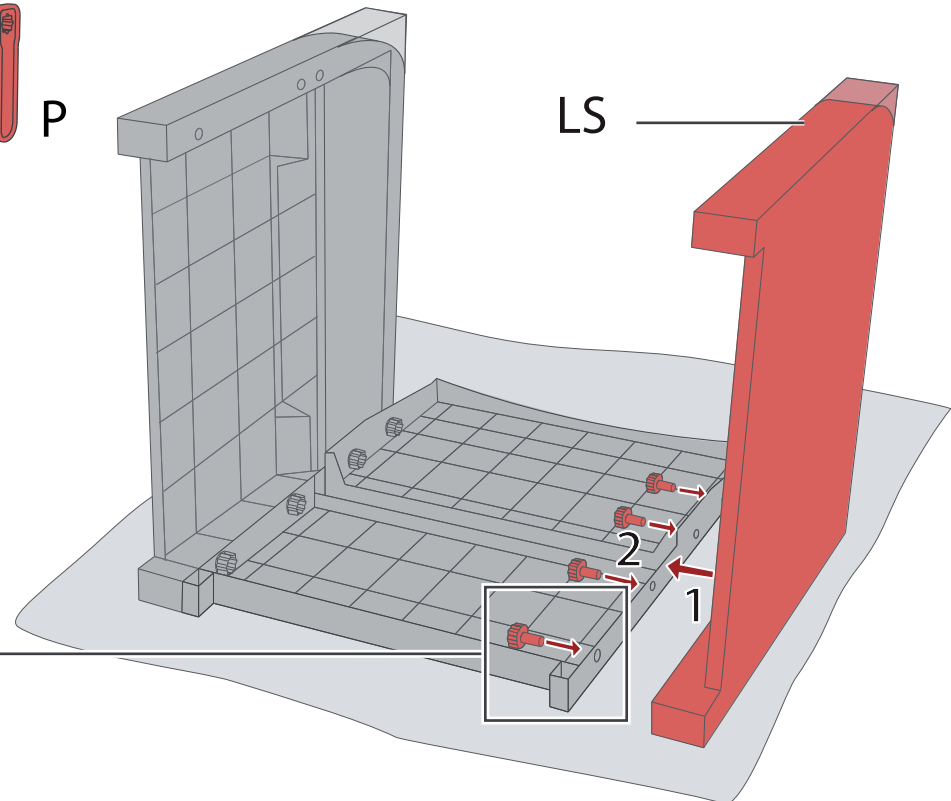
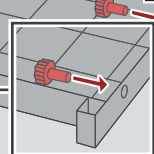

8

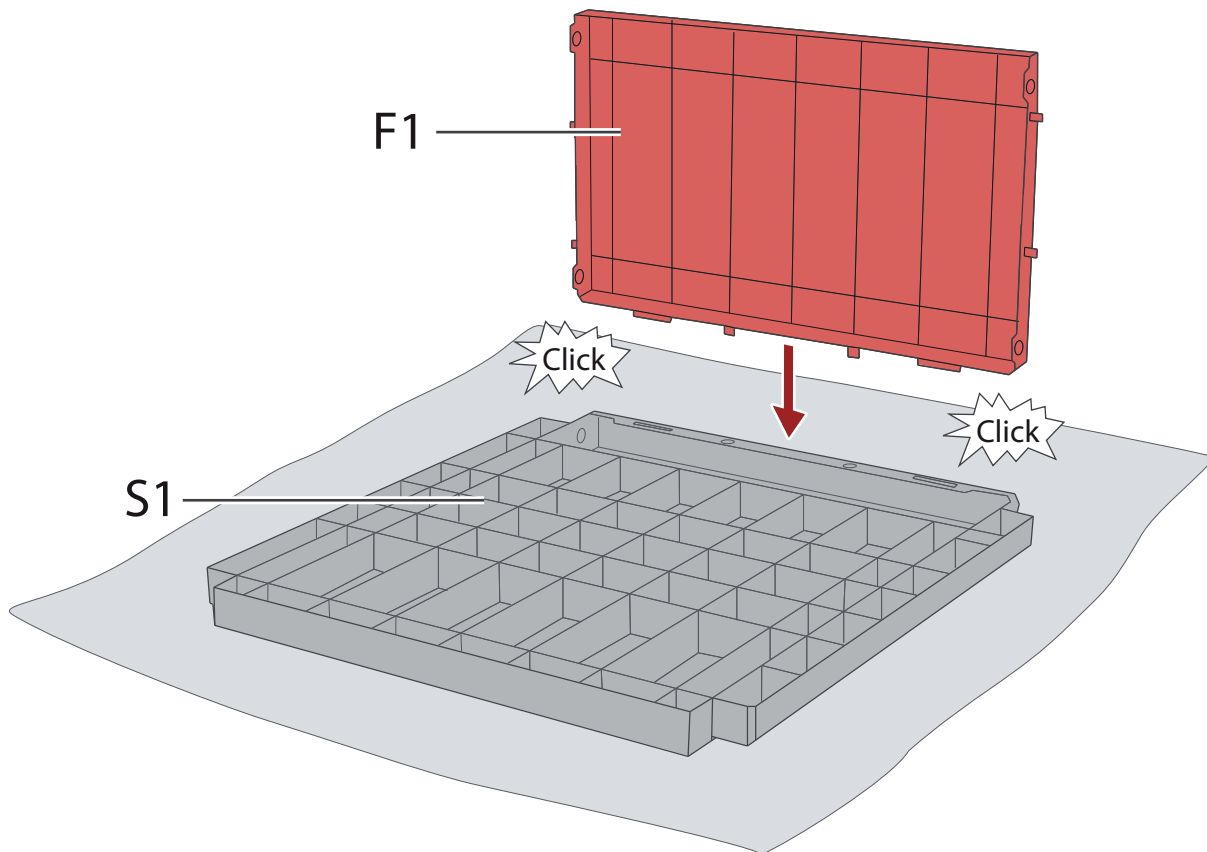

9

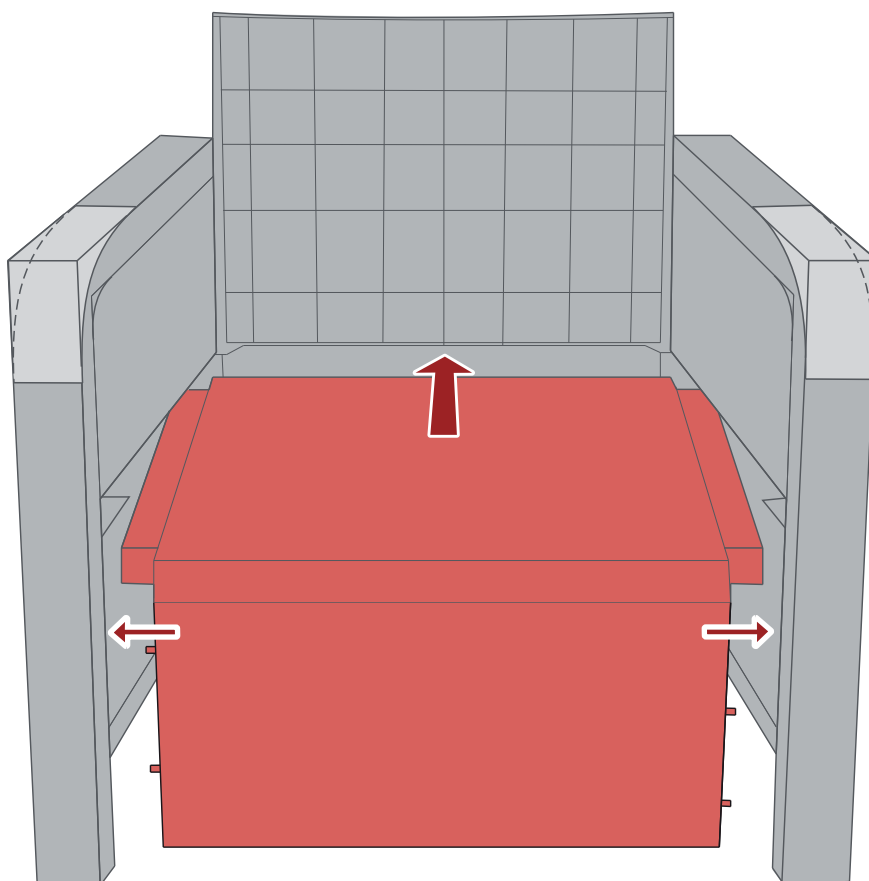

10

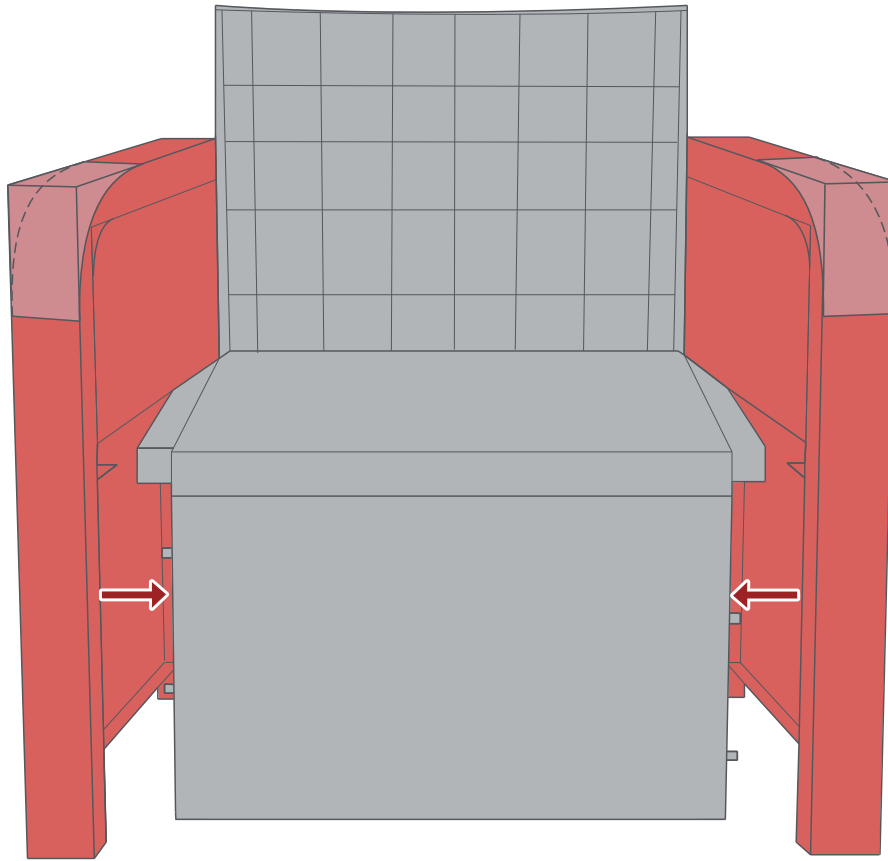

11

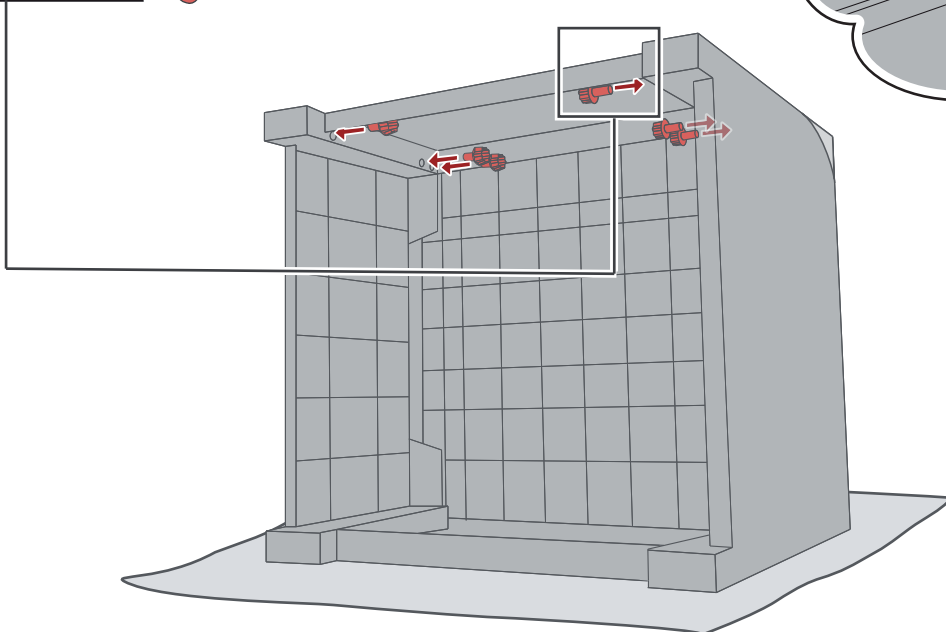
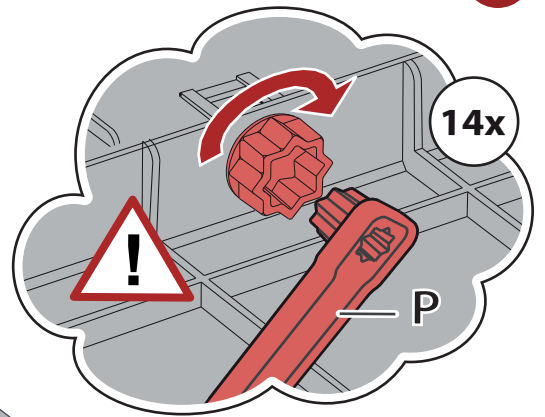
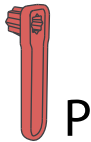
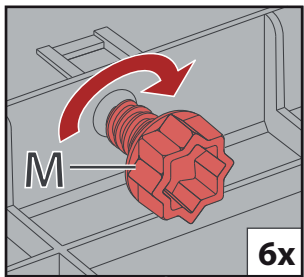

12

