

FISA DE MONTAJ

Lv6. SUSPENDAT CU O USA

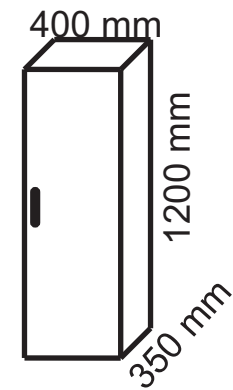

PASUL 1:

Se prind cele doua laterale (1) si (2) si politele (5) de capacul (3) in gaurile existente, folosind eurosuruburi si cheia imbus. Apoi se aseaza spatele (6) din PFL in canalele existente pe laterale si separator.

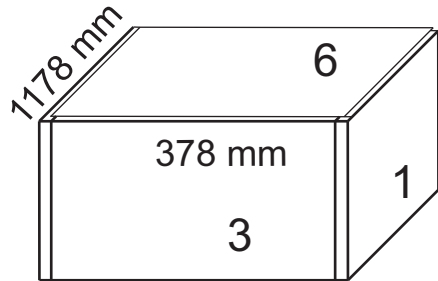

PASUL 2:

Se prinde apoi si capacul (4) de laterale si separator tot prin eurosuruburi. Se prinde manerul de usa (7) folosind suruburile M4x20.

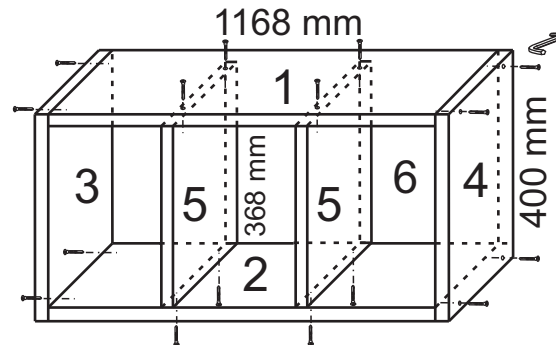



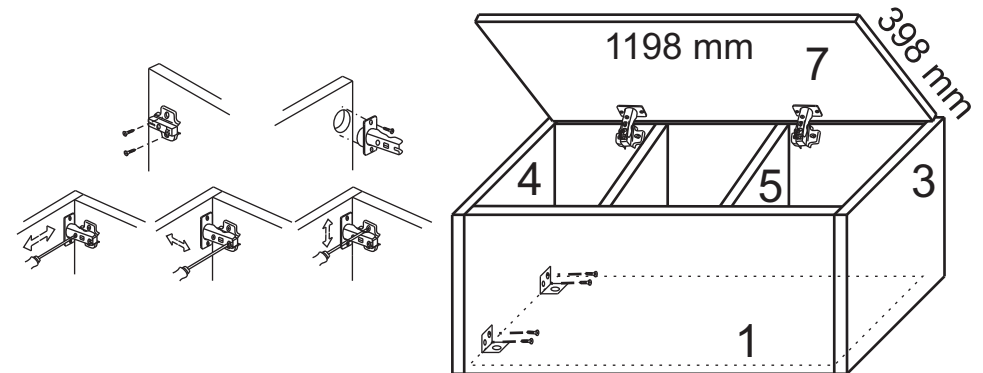

PASUL 3:

Se prind balamalele de usa si contrele de laterala (2), se realizeaza ansamblul balama-contrabalama reglandu-se usa. Se prind coltarii agatatori de capacul (4) prin holsuruburi 3.5x16 apoi se fixeaza corpul de perete.

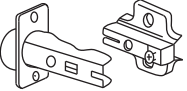
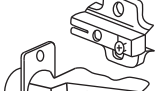
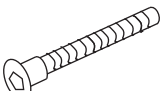

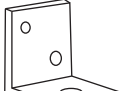
ACCESORII

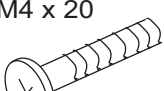
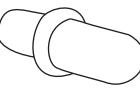
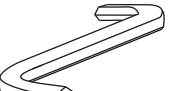
Balama aplicate	Balama semiaplicata	Eurosurub	Holsurub	Coltar agatator	Tinte	Maner	Surub	Suport polita	Cheie imbus
									
Buc. x 2	x 0	x 16	3,5 x 16 x 12	x 2	x 20	x 1	M4 x 20 x 2	x 0	x 1