

FISA DE MONTAJ

Lv16. SOLDAT CU O USA

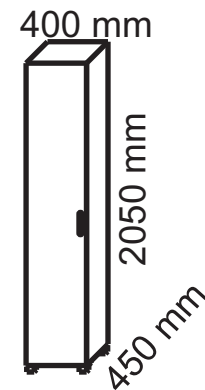

PASUL 1:

Se prinde capacul (3) si politele (5) de cele doua laterale (1) si (2) in gaurile existente, folosind eurosuruburi si cheia imbus. Apoi se aseaza spatele (6) din PFL in canalele existente pe laterale si capacul (3).

PASUL 2:

Se prinde apoi si capacul (4) de laterale tot prin eurosuruburi. Se prinde manerul de usa (7) folosind suruburile M4x20.



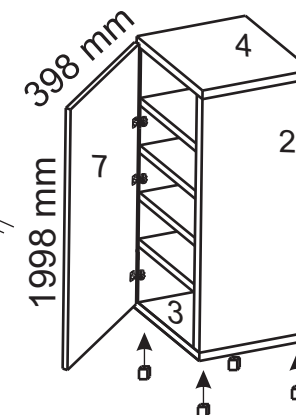
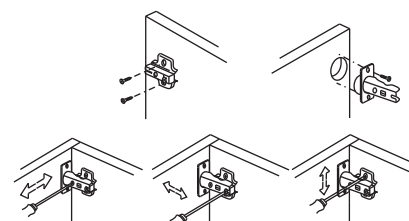
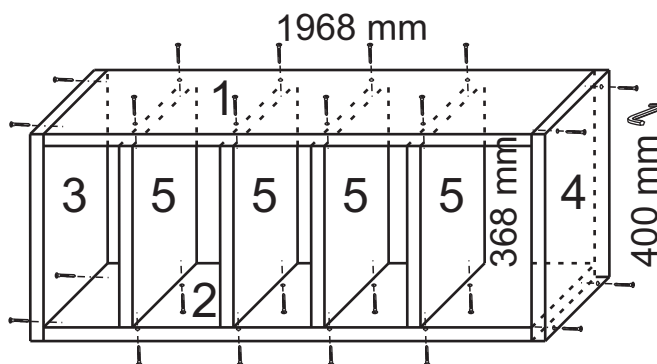
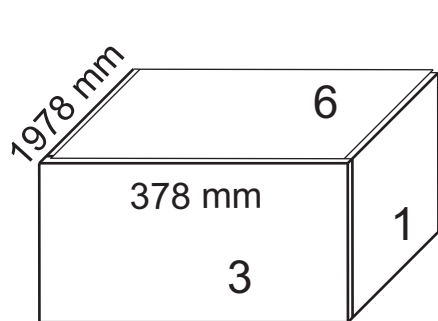

PASUL 3:

Se prind balamalele de usa si contrele de laterala (1), se realizeaza ansamblul balama-contrabalama reglandu-se usa.

Apoi se monteaza picioarele pe capacul (3).

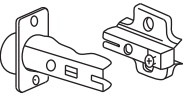
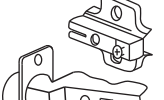
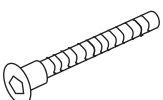

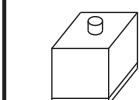
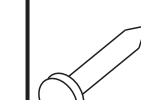
ACCESORII

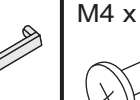
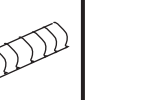
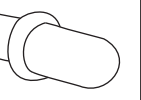
Balama aplicate	Balama semiaplicata	Eurosurub	Holsurub	Picioare H50	Tinte	Maner	Surub	Suport polita	Cheie imbus
									
Buc. x 3	x 0	x 24	3,5 x 16 x 12	x 4	x 0	x 1	x 2	x 0	x 1