

PRODUCT : Universal wardrobe 2 doors – 800
 PRODUS : Dulap universal cu 2 usi – 800

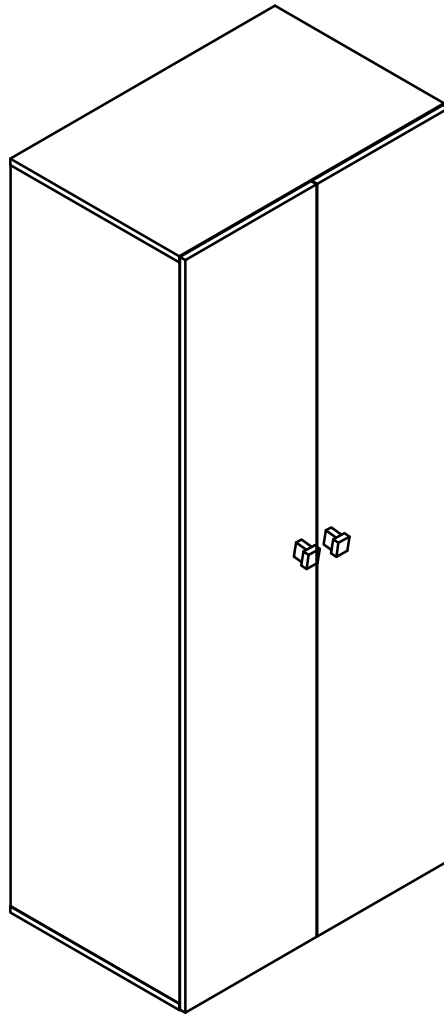

Please read these instructions because they do not provide guarantee for installation defects due to an incorrect installation

Va rugam sa cititi cu atentie aceste instructiuni de montare deoarece nu asiguram garantia pentru defecte datorate unui montaj incorect.

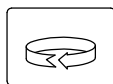
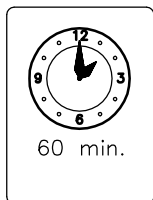
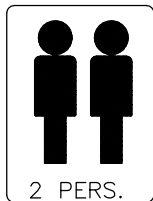
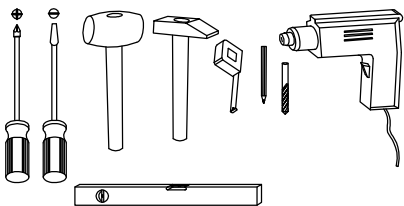

– Strangere
 – Screw



– Apasare
 – Press



– Introducere prin apasare
 – Introducing by pressing

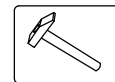

– Introducere prin ciocanire
 – Introducing by hummer

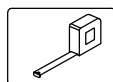

– Masurare
 – Measurement



– Turn/Rotate
 – Intoarceti/rotiti

ENG Dear customer,

- As a furniture producer we would like to inform you that a wall fixing furniture can be good only if the connection between fixing material (plugs) and the wall is better. For the suspended items check the wall and use only appropriate type of dowels (brick, BCA, plasterboard, etc.) purchased from a specialty store.
- Assembler is ultimately responsible for a fixed wall. Installation and laying of electrical items will be made only by qualified personnel and authorized.
- Follow the description and specification of Charge assembly instructions - in case overload that may occur due to children playing, because people, material or due to other factors - we assume no liability as a manufacturer of furniture.
- O perfect functionality of the furniture is assured only if the settlement this adjusts the horizontal and vertical. Only after that will adjust the doors.
- All screws and removable connection elements will be checked and tightened after 5 to 6 weeks to ensure safety of final fixation.
- **Do not use abrasive cleansers**
- If not follow the instructions on the use, maintenance or installation, if the products or changes, if changes or used parts that do not meet original pieces, then lose any warranty or claim responsibility of the manufacturer of furniture.

Terms of presentations for claims:

Claims submitted must contain the company produces:

1. Documents proving purchase (receipt / invoice).
2. Labels of packages (including serial number) which were found defective, or production mistakes
3. Mechanical defects must be claimed immediately after discovering manufacturing company, before assembling furniture.
4. Claims of mechanical defects for already assembled furniture will not be considered.
5. Elements claimed must be specified according to the assembly instructions

RO Stimate client,

- In calitate de producator de mobila am dori sa va informam ca o fixare a mobilei de perete poate fi buna doar daca legatura dintre materialul de fixare (dibluri) si perete este buna. In cazul corpurilor suspendate verificati peretele si folositi doare dibluri cospunzatoare tipului de perete (caramida, BCA, rigips, etc.) achizitionate dintr-un magazin de specialitate. In definitiv montatorul este raspunzator de fixarea de perete.
- Montarea si pozarea articolelor electrice se va efectua doar de catre personal calificat si autorizat.
- Respectati desciera si specificatiile de incarcare din instructiunile de montaj - in caz de supraincarcare ce poate sa apara datorita copiilor care se joaca, datorita persoanelor, materialului sau datorita altor factori - nu ne asumam nici oraspundere ca producator de mobila.
- O functionalitate perfecta a mobilei este asigurata doar in cazul in care la asezare aceasta se regleaza pe orizontala si verticala. Doar dupa aceasta se vor regla usile.
- Toate suruburile si elementele de imbinare demontabila vor trebui verificate si stranse dupa 5 pana la 6 saptamani pentru a se asigura o siguranta definitiva a fixarii.
- **Nu folositi agenti de curatire abrazivi**
- In cazul in care nu se respecta instructiunile de utilizare, de deservire sau de montaj, daca se efectueaza modificari ale produselor, daca se schimba piese sau se folosesc pese care nu corespund pieselor originale, atunci se pierde orice garantie sau pretentie de responsabilitate din partea producatorului de mobila.

Conditii de prezentare a reclamatilor:

Reclamatii prezentate companiei producatoare trebuie sa contina:

1. Documentele ce dovedesc cumpararea (chitanta/factura).
2. Etichete ale ambalajelor (inclusiv numar de serie) la care au fost depistate defecte, sau greseli de productie.
3. Defectele mecanice trebuie reclamate companiei producatoare imediat dupa depistare, inainte de asamblarea mobilierului.
4. Reclamatii privind defectele mecanice ale mobilierului deja asamblat nu vor fi luate in considerare.
5. Elementele reclamate trebuie specificate conform schitei de montaj

1.285

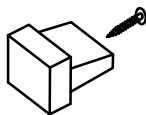

4315



10167

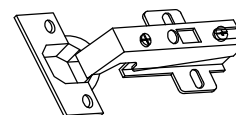

7.154

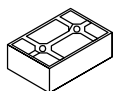

83024200



73182900



P23010

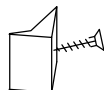

8.804.1



24030.1



8637



300012

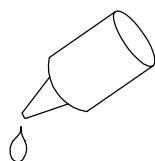

300053



6493



6538

∅3.5x16



8327

∅3x16



300302

∅5x25



1-12-A



300054



PRODUCT : Universal wardrobe 2 doors – 800
PRODUS : Dulap universal cu 2 usi – 800

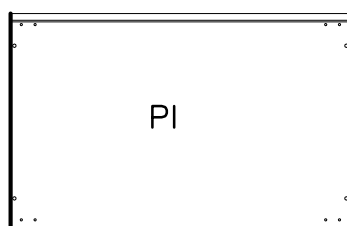
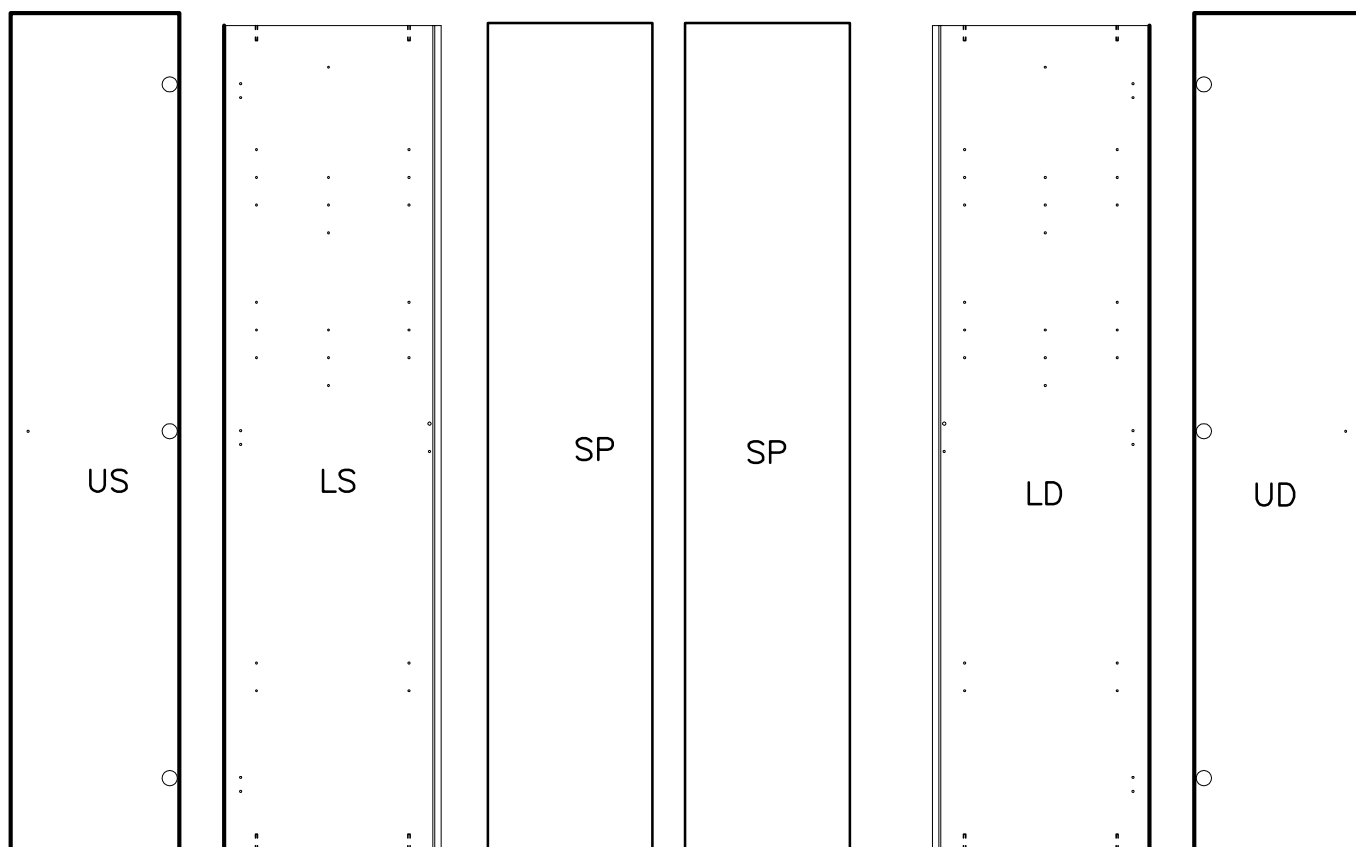
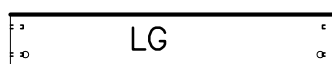
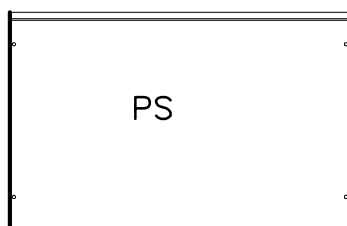

1

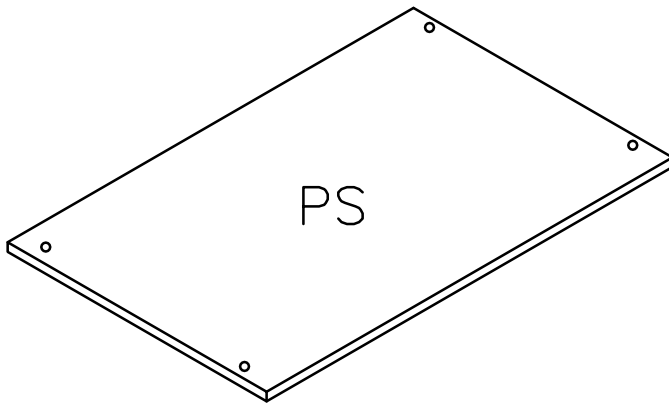

2

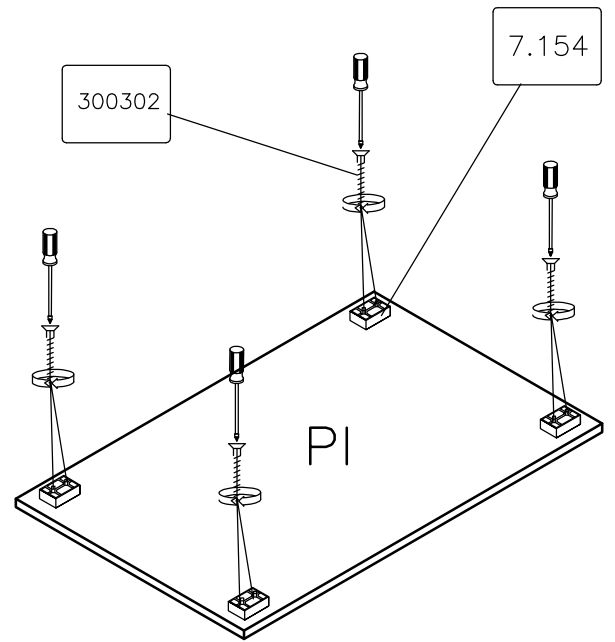

3

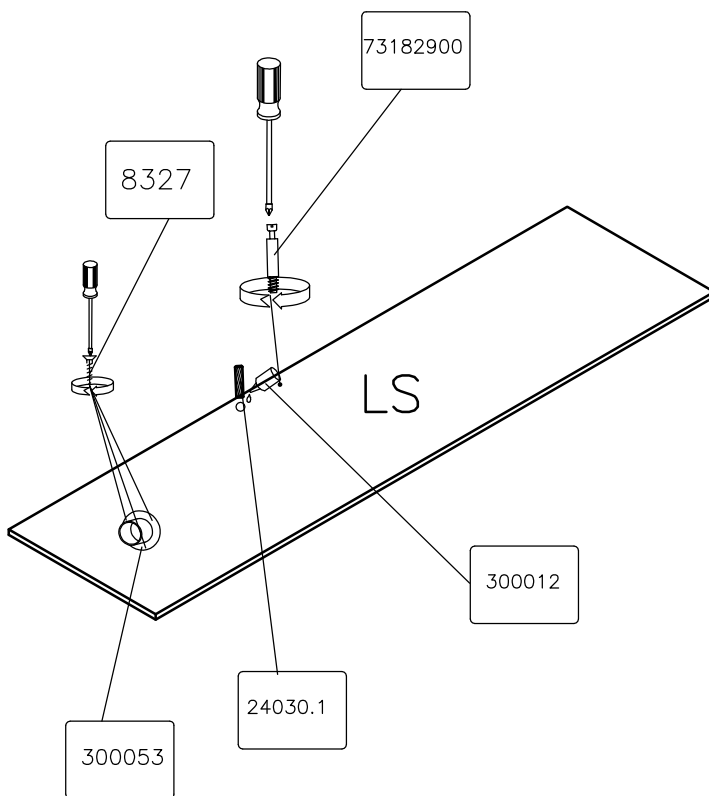

4

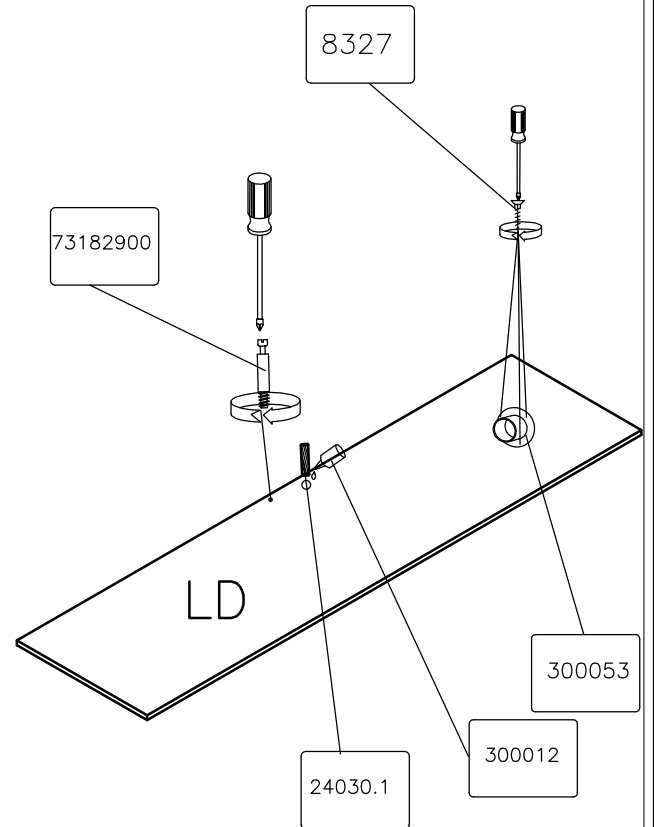

5

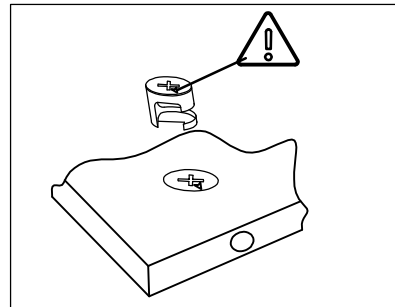
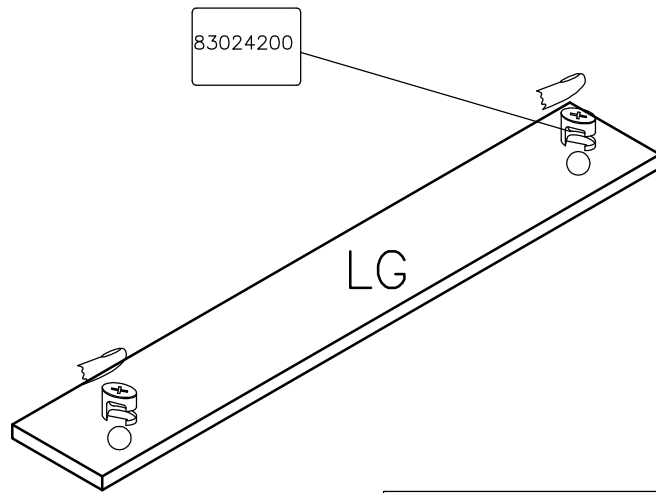

6

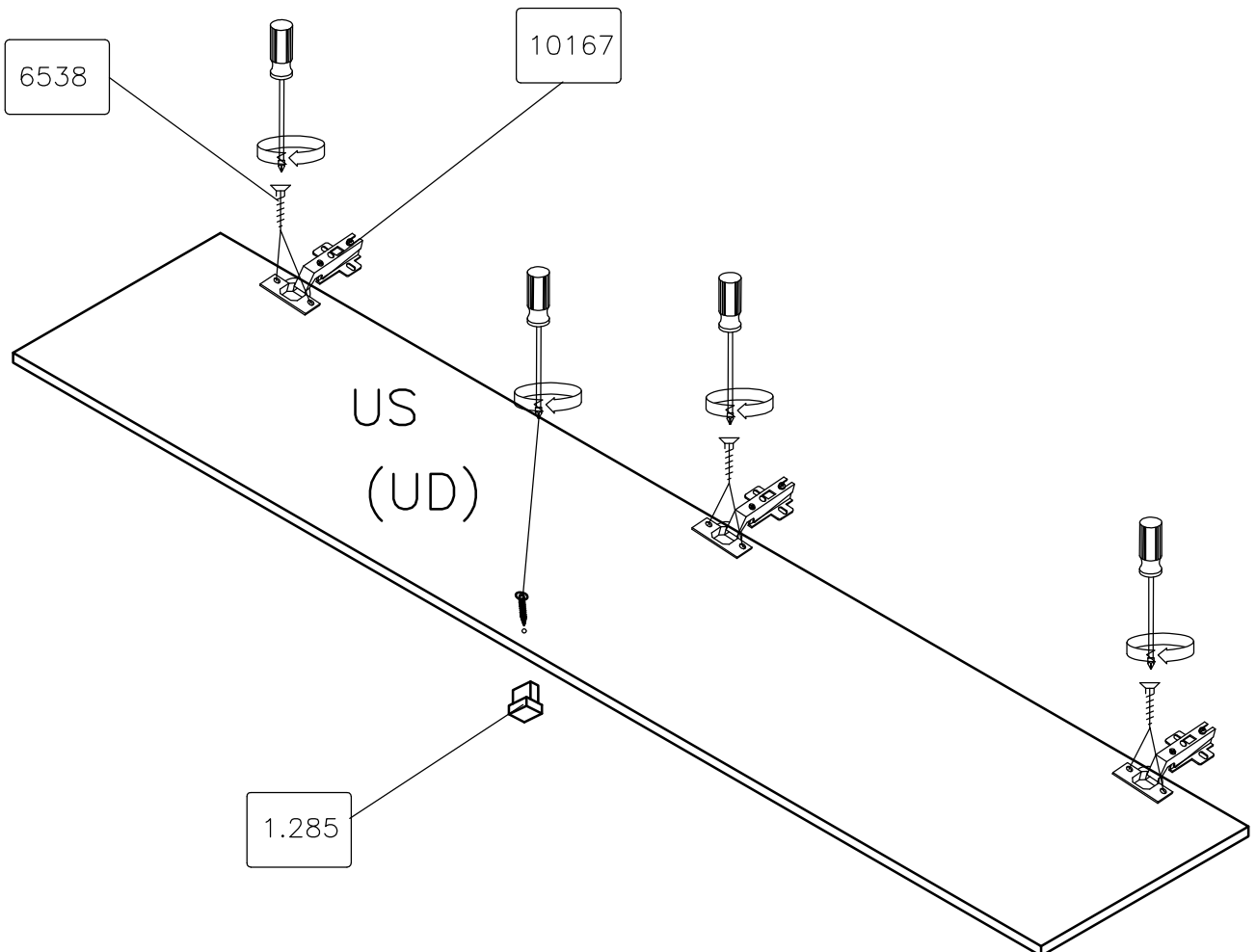

7

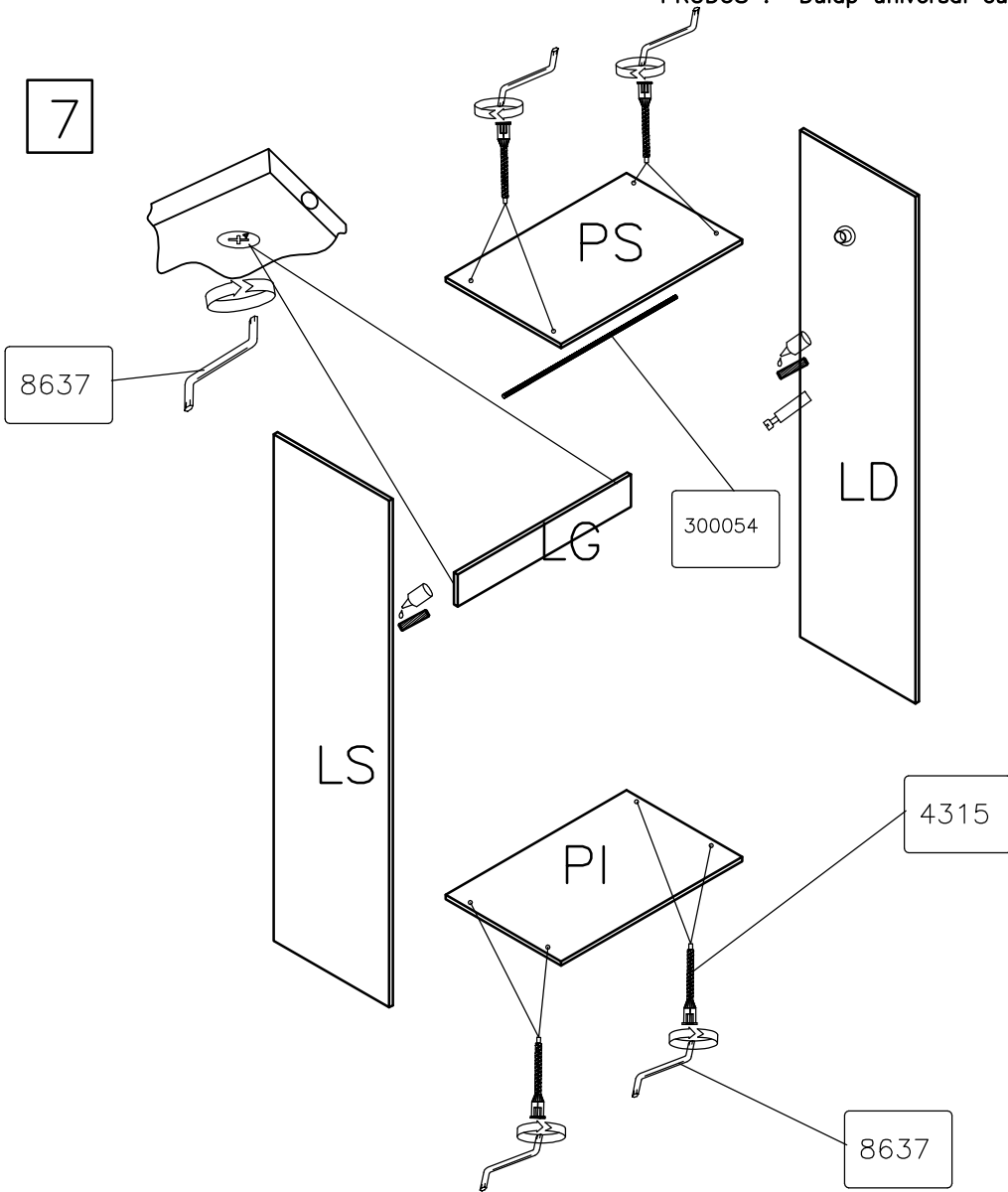

8

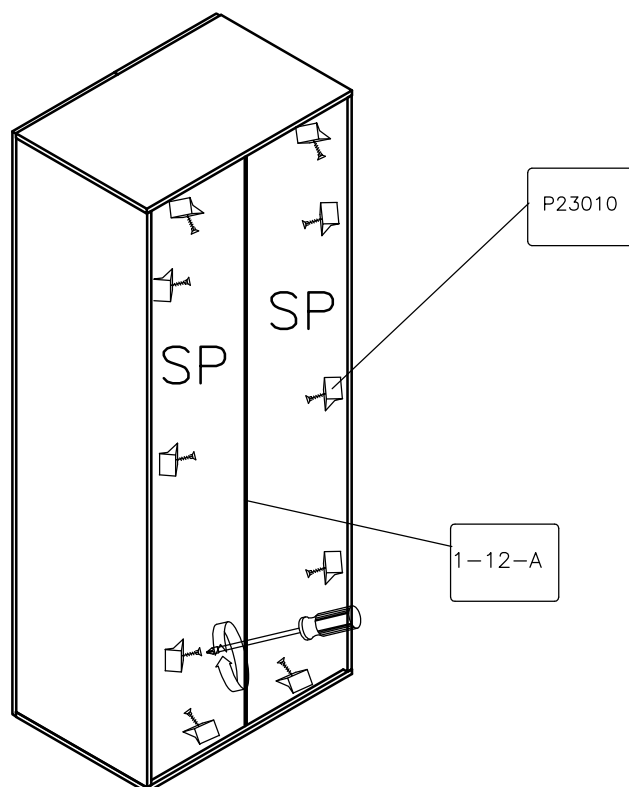

9

