

Cant.	Descriere
-------	-----------

1	ALPHA3 25-40 180
---	------------------



Nr. Produs: La cerere

High-efficiency circulator pump with permanent-magnet motor (ECM technology) and integrated electronic performance adaptation due to continuously variable speed control for circulation of clean heating water according to VDI 2035.

Features and benefits:

- New Read out of pump performance. Enable the use of ALPHAreader for heat emission balancing.
- New Adv. Dry run protection. Protect the pump in case of no water in the pump.
- New Improved start. Secure start under tough conditions
- New Manual Summer mode. Save energy during summertime and ensure safe start in the heating season
- AUTOADAPT function will automatically find the best setpoint- save energy consumption and set-up time.
- Insulating shells are supplied with pumps to minimize heat loss in heating and cooling systems.
- Display showing actual power consumption in Watt or actual flow in m³/h to control design paramters.
- Best energy efficiency index (EEL) in the market provide highest energy savings during a year.
- Stainless-steel pump housings are available if the application is sensitive or SS is a demand.
- Energieeinsparverordnung – EnEV §14(3). Complies with the German regulation for energy saving in buildings and building systems
- Automatic Night Setback that further reduces the energy consumption.
- Simple selection among three constant-pressure curves, three proportional-pressure curves or three fixed speeds with only one button . Quick and simple setup.
- ALPHA plug. Easy, quick and safe electrical connection.
- ALPHA2 is suitable for cold-water systems. Higher application flexibility .
- Electro-coated pump housing. No corrosion issues.
- No external motor protection is required. Reduced installation time and costs.

Lichid:

Lichide pompatate: Ap
 Gama temperaturii lichidului: 2 .. 110 °C
 Temperatura lichidului în timpul func ion rii: 60 °C
 Densitate: 983.2 kg/m³

Tehnic:

Clasa TF: 110
 Aprob ri pe etichet : VDE,GS,CE

Materiale:

Corpul pompei (stator): Font
 EN-GJL-150
 ASTM A48-150B
 Rotor: PES 30%GF

Instala ie:

Gama temperaturii ambientale: 0 .. 40 °C
 Presiune de func ionare maxim : 10 bar
 Racordarea pompei la instala ie: G 1 1/2
 Presiune maxim de func ionare: PN 10
 Distan a dintre porturi: 180 mm

Cant.	Descriere																				
	<p>Date electrice:</p> <table><tr><td>Putere de intrudus - P1:</td><td>3 .. 18 W</td></tr><tr><td>Frecven a re elei electrice:</td><td>50 Hz</td></tr><tr><td>Tensiune nominal :</td><td>1 x 230 V</td></tr><tr><td>Curent consumat maxim:</td><td>0.04 .. 0.18 A</td></tr><tr><td>Grad de protec ie (IEC 34-5):</td><td>X4D</td></tr><tr><td>Clas de izolare (IEC 85):</td><td>F</td></tr></table> <p>Altele:</p> <table><tr><td>Energy (EEI):</td><td>0.15</td></tr><tr><td>Greutate net :</td><td>2.01 kg</td></tr><tr><td>Greutate brut :</td><td>2.13 kg</td></tr><tr><td>Volum de transport:</td><td>0.004 m³</td></tr></table>	Putere de intrudus - P1:	3 .. 18 W	Frecven a re elei electrice:	50 Hz	Tensiune nominal :	1 x 230 V	Curent consumat maxim:	0.04 .. 0.18 A	Grad de protec ie (IEC 34-5):	X4D	Clas de izolare (IEC 85):	F	Energy (EEI):	0.15	Greutate net :	2.01 kg	Greutate brut :	2.13 kg	Volum de transport:	0.004 m ³
Putere de intrudus - P1:	3 .. 18 W																				
Frecven a re elei electrice:	50 Hz																				
Tensiune nominal :	1 x 230 V																				
Curent consumat maxim:	0.04 .. 0.18 A																				
Grad de protec ie (IEC 34-5):	X4D																				
Clas de izolare (IEC 85):	F																				
Energy (EEI):	0.15																				
Greutate net :	2.01 kg																				
Greutate brut :	2.13 kg																				
Volum de transport:	0.004 m ³																				

La cerere ALPHA3 25-40 180 50 Hz

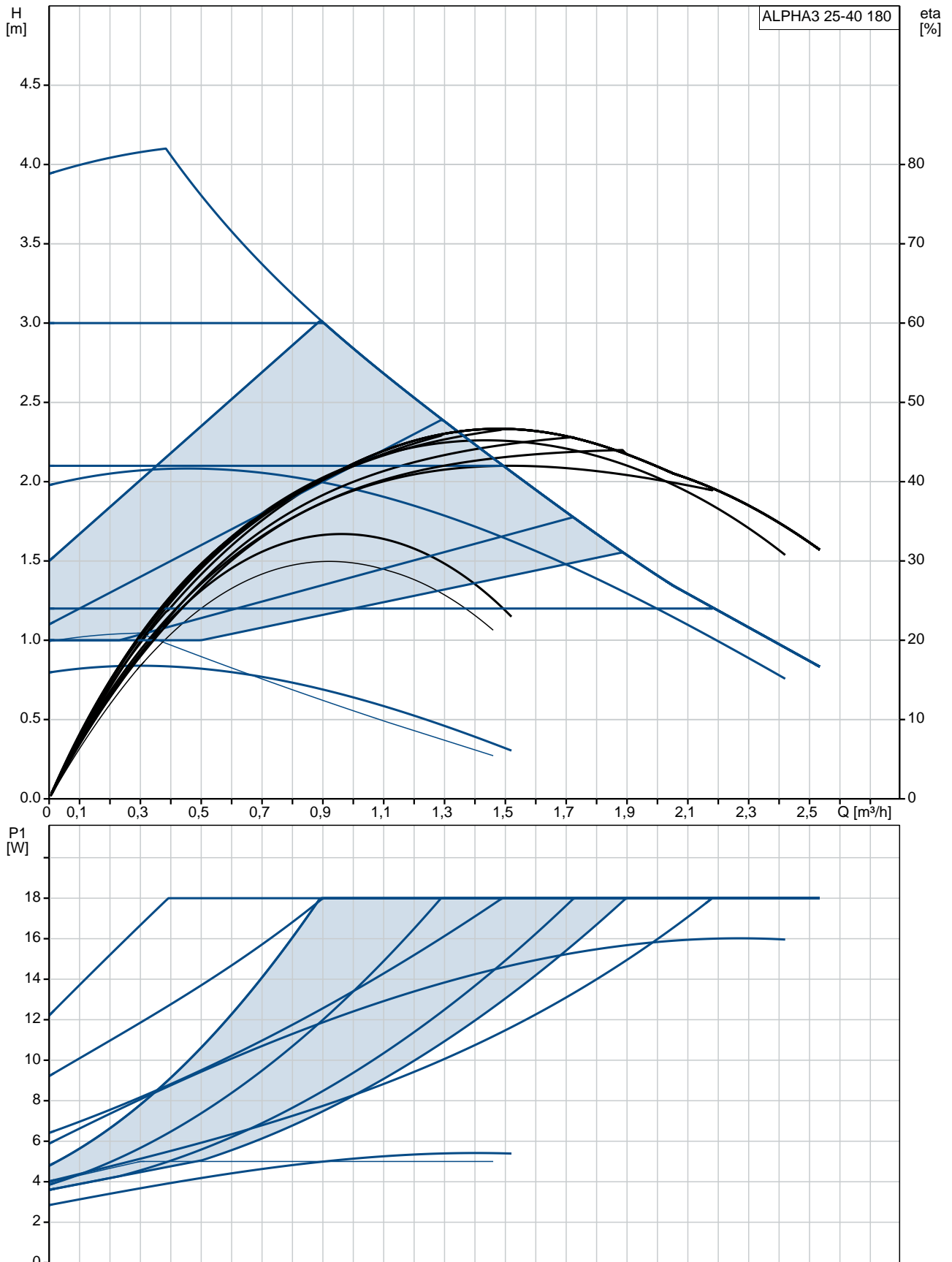

Descriere	Valori i tipuri
Informa ii generale:	
Nume produs::	ALPHA3 25-40 180
Nr. produs::	La cerere
Numărul EAN::	La cerere
Tehnic:	
În l ime de pompare max.:	40 dm
Clasa TF:	110
Aprob ri pe etichet :	VDE,GS,CE
Model:	A
Materiale:	
Corpul pompei (stator):	Font EN-GJL-150 ASTM A48-150B
Rotor:	PES 30%GF
Instala ie:	
Gama temperaturii ambientale:	0 .. 40 °C
Presiune de func ionare maxim :	10 bar
Racordarea pompei la instala ie:	G 1 1/2
Presiune maxim de func ionare:	PN 10
Distan a dintre porturi:	180 mm
Lichid:	
Lichide pompate:	Ap
Gama temperaturii lichidului:	2 .. 110 °C
Temperatura lichidului în timpul func ion rii:	60 °C
Densitate:	983.2 kg/m ³
Date electrice:	
Putere de introdus - P1:	3 .. 18 W
Frecven a re elei electrice:	50 Hz
Tensiune nominal :	1 x 230 V
Curent consumat maxim:	0.04 .. 0.18 A
Grad de protec ie (IEC 34-5):	X4D
Clas de izolare (IEC 85):	F
Tip protec ie motor încorporat :	F R
Protec ie termic :	ELEC
Control:	
Automat noaptea:	func ionare redus automat pe timp te noapte inclus
Pozi ia cutiei de conexiuni:	6H
Altele:	
Energy (EEI):	0.15
Greutate net :	2.01 kg
Greutate brut :	2.13 kg
Volum de transport:	0.004 m ³
Regiuni de vânzare:	D

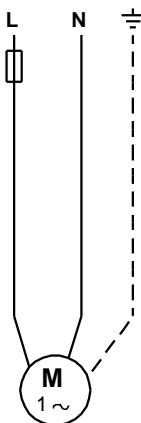
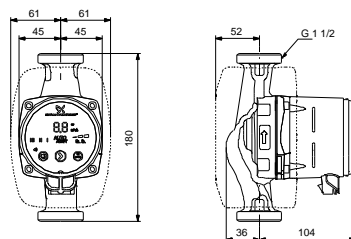
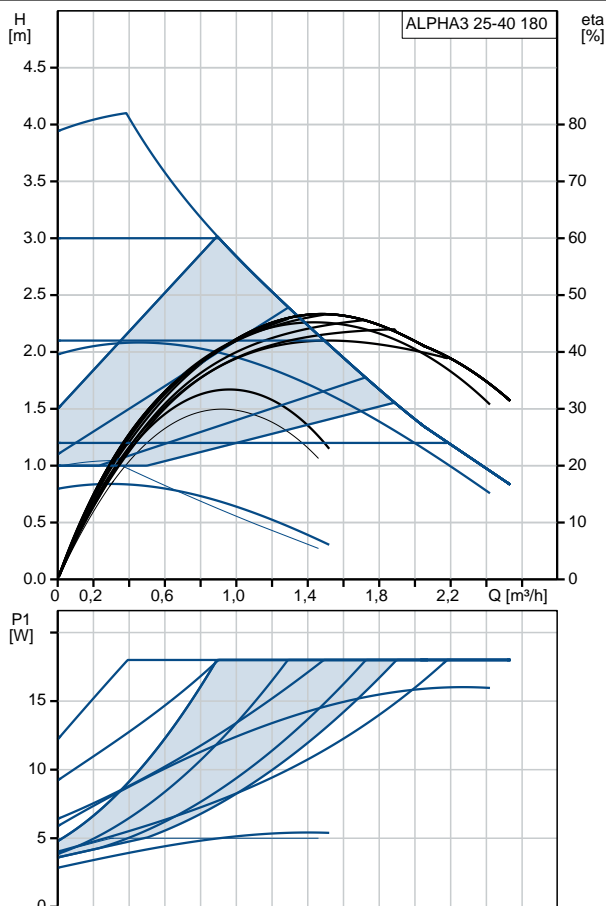

La cerere ALPHA3 25-40 180 50 Hz

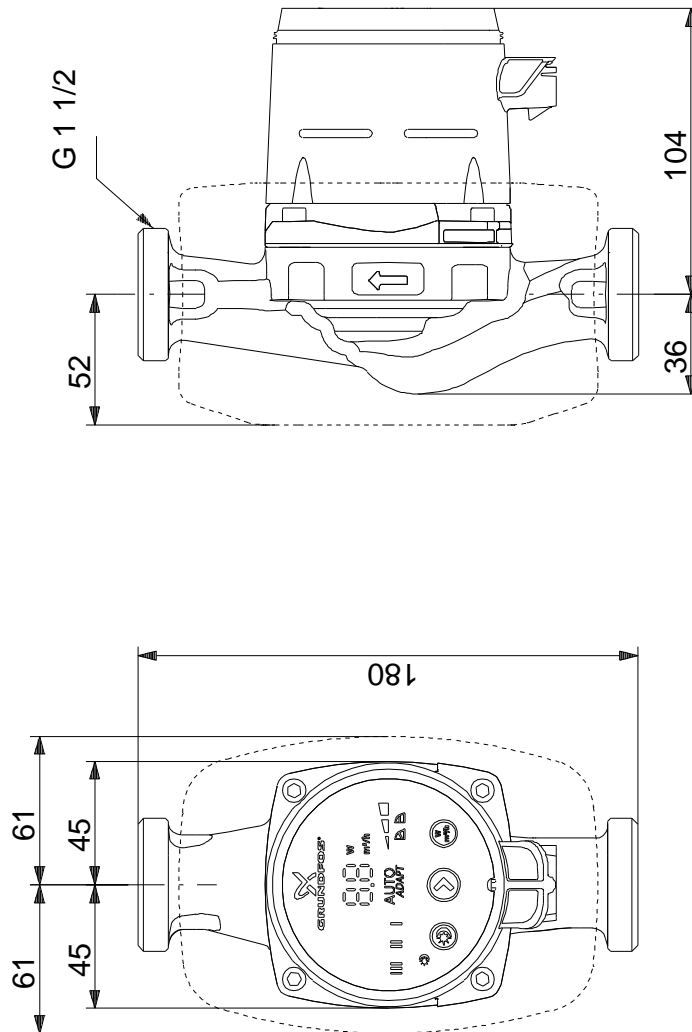

Not : Toate unit ile sunt in [mm] daca nu sunt altele specificate.
Negare: Acest desen dimensional simplificat nu prezint toate detaliile.

La cerere ALPHA3 25-40 180 50 Hz

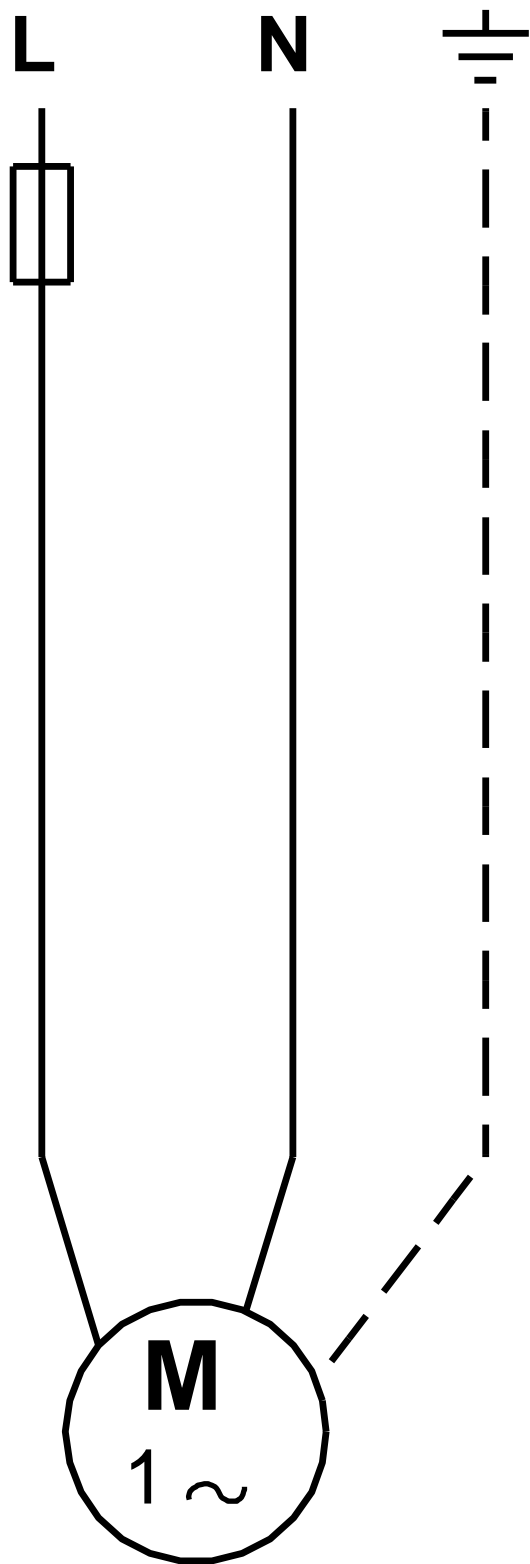

Not ! Toate unit ile sunt în [mm] dac nu sunt altele specificate.