

Fișă tehnică Canal, tip WDK 40060

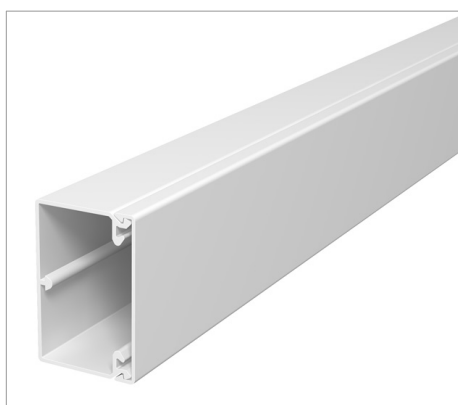

Capac și canal cu bază perforată.

Tip	Culoare	Lungime mm	Amb. m	Greutate kg/100 m	Nr. art.
WDK40060RW	alb pur; RAL 9010	2000	24	56.200	6191134
WDK40060CW	alb crem; RAL 9001	2000	24	56.200	6020887
WDK40060LGR	gri deschis; RAL 7035	2000	24	56.200	6027024
WDK40060GR	gri piatră; RAL 7030	2000	24	56.200	6025633

PVC Policlorură de vinil

l €/m

