

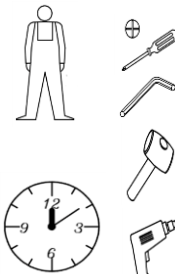

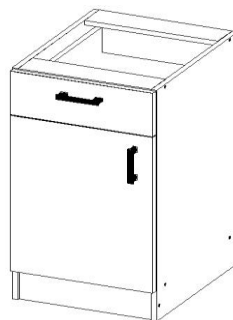









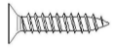

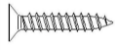

## START

CORP BAZA 1SERTAR 1USA 80x40x50  
VERSIUNEA: 01/30.04.2020



30 min

Va rugam sa verificati continutul coletului, existenta accesoriilor de feronerie, precum si a pieselor mentionate in schita de montaj. In cazul constatarii lipsurilor (feronerie, piese) sau defectiunilor va rugam sa anuntati personalul LUX ARTIM in termen de 24 ore de la achizitionarea produsului, comunicand lipsurile si defectiunile constatate si numarul stampilei C.T.C. de pe ambalaj. In cazul necomunicarii defectiunilor sau lipsurilor constatate in termenul de mai sus, SC LUX-ARTIM SRL nu-si asuma raspunderea pentru eventualele neconformitati. Va multumim pentru intelegere.

	
A - Eurosurub 5x50 – 18buc	H - Balama aplicata – 2buc
	
B - Holtzsurub 3.5x16 – 20buc	I – Surub maner 4x40 2buc
	
C - Holtzsurub 4x16 – 4buc	J - Cuie HDF - 28buc
	
D - Holtzsurub 4x18 – 4 buc	K- Holtzsurub 4x30 – 2 buc
	
E – Maner – 2buc	L-Glisiere 450mm-1set
	
F - Surub maner 25mm – 2 buc	M – Cheie imbus 6mm – 1buc
	
G-Picior negru M6+busca-4buc	N – Cheie imbus 5x50 – 1buc
	
G-Picior negru M6+busca-4buc	O – Capacele adezive -10 buc

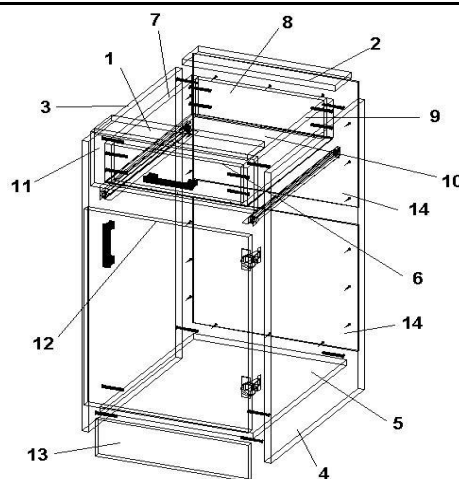

1 -Lonjeron fata	8-Spate sertar
2-Lonjeron spate	9-Laterala sertar
3-Laterala	10-Fund sertar
4-Laterala	11-Fata sertar
5-Placa fund	12-Usa
6-Fata interior sertar	13-Plinta
7-Laterala sertar	14-Spate HDF 2buc

### Instructiuni de asamblare corp masca chiuveta 2 usi

- Se fixeaza cele 4 buc picioare G pe lateralele 3 si 4, folosind cheia imbus de 6mm N
- Se cupleaza placa fund 5 cu lateralele 3 si 4 folosind 4buc eurosuruburi A.
- Se monteaza lonjeroanele 1 si 2 intre lateralele 3 si 4 cu eurosuruburi A.
- Se monteaza plinta 13 intre lateralele 3 si 4, folosind eurosuruburi A.
- Se monteaza sinele de la glisierile L pe lateralele 3 si 4 cu holtzsuruburile B.
- Se prind cele 2 placi spate Hdf 14 de lateralele 3 si 4, fundul 5 si lonjeronul 2 folosind cuie Hdf J.
- Se monteaza balamalele H pe usa 12 cu holtzsuruburi D.
- Se monteaza bratul balamalelor H pe laterala 4 folosind holtzsuruburi C.
- Se fixeaza manerul E pe usa 12 folosind suruburi F.
- Se cupleaza intre ele fata interior sertar 6, laterala sertar 7, spate sertar 8 si laterala 9 cu eurosuruburi A.
- Se prinde fund sertar 10 de cadrul asamblat anterior, folosind cuie Hdf J.
- Se monteaza glisierile L pe lateralele sertarului 7 si 9 cu holtzsuruburile B.
- Fata sertarului 11 se monteaza pe sertar, se fixeaza cu manerul E si suruburile I, apoi se fixeaza cu holtzsuruburile K.
- Se aplica capacele autoadezive O pe toate eurosuruburile vizibile.

Va rugam sa verificati continutul coletului, existenta accesoriilor de feronerie, precum si a pieselor mentionate in schita de montaj. In cazul constatarii lipsurilor (feronerie, piese) sau defectiunilor va rugam sa anuntati personalul LUX ARTIM in termen de 24 ore de la achizitionarea produsului, comunicand lipsurile si defectiunile constatate si numarul stampilei C.T.C. de pe ambalaj. In cazul necomunicarii defectiunilor sau lipsurilor constatate in termenul de mai sus, SC LUX-ARTIM SRL nu-si asuma raspunderea pentru eventualele neconformitati.







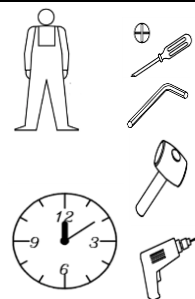
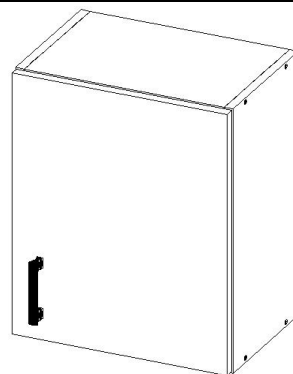



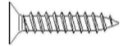

Va multumim pentru intelegere.

## START

CORP SUSPENDAT 1USA 51x40x30  
VERSIUNEA: 01/30.04.2020

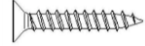

30 min

	
A-Eurosurub 5x50 – 8 buc	H-Balama aplicata – 2 buc
	
B-Capacele adezive -8 buc	I-Surub maner 25mm 2 buc
	
C-Holtzsurub 4x16 – 8buc	J – Cuie Hdf – 14 buc
	
D – Holtzsurub 6x70 – 2 buc	K–Cheie imbus 5x50 – 1 buc
	
E-Maner – 1 buc	L-Holtzsurub 4x18 – 4buc
	
F-Suport polita - 4buc	M-Coltar L demontabil -2buc
	
G-Diblu 10x60 - 2buc	

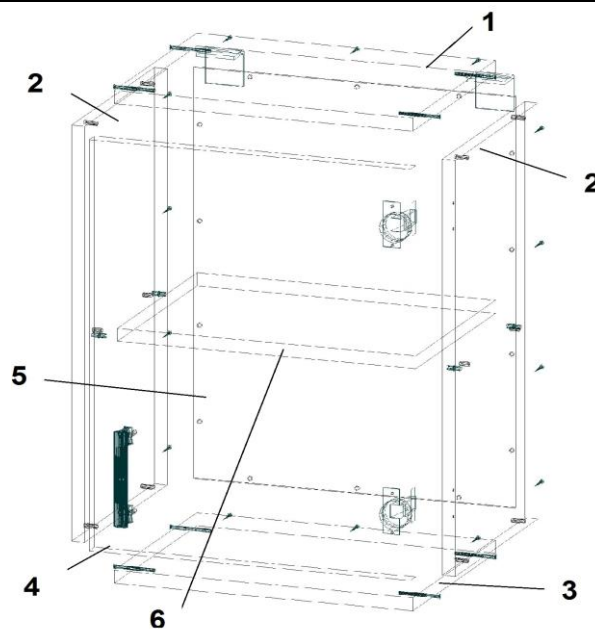

1 - Placa fund PAL – 1 buc	4 - Usa PAL - 1 buc
2 - Laterala PAL – 2 buc	5 - Spate hdf - 1 buc
3 - Fund PAL – 1 buc	6 - Polita - 1 buc

### Instructiuni de asamblare corp masca chiuveta 2 usi

1. Se cupleaza capacul 1 si fundul 3 intre lateralele 2 folosind 8 buc eurosuruburi A
2. Se prinde, folosind cuie HDF J, placa spate hdf 5 de lateralele 2 si placile 1 si 3 prin batere cu ciocanul
3. Se monteaza coltarele demontabile M pe capacul 1 in colturile corpului cu ajutorul holtzsuruburilor C
4. Se monteaza balamalele H pe usa 4 cu ajutorul holtzsuruburilor L
5. Se monteaza bratul balamalelor H pe laterala 2 cu ajutorul holtzsuruburilor C
6. Se monteaza manerul E pe usa 4 cu ajutorul suruburilor I
7. Se aplica capacelele adezive B pe fiecare eurosurub A
8. Se monteaza in perete la inaltimea dorita diblurile G folosind o nivela pentru asigurarea orizontalitatii
9. Se aseaza corpul pe pozitie si se fixeaza de perete cu holtzsuruburi D prin coltarele M in diblurile G montate deja in perete
10. La 24 de ore dupa montaj se strang din nou holtzsuruburile D in diblurile G pentru fixarea definitiva de perete







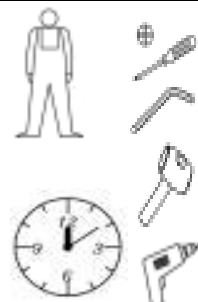
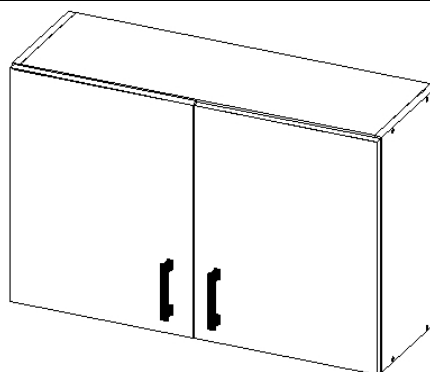



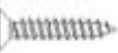

Va rugam sa verificati continutul coletului, existenta accesoriilor de feronerie, precum si a pieselor mentionate in schita de montaj. In cazul constatarii lipsurilor (feronerie, piese) sau defectiunilor va rugam sa anuntati personalul LUX ARTIM in termen de 24 ore de la achizitionarea produsului, comunicand lipsurile si defectiunile constatate si numarul stampilei C.T.C. de pe ambalaj. In cazul necomunicarii defectiunilor sau lipsurilor constatate in termenul de mai sus, SC LUX-ARTIM SRL nu-si asuma raspunderea pentru eventualele neconformitati.  
Va multumim pentru intelegere.

## START

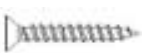
CORP SUSPENDAT 2USI 51x80x30  
VERSIUNEA: 01/30.04.2020

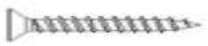

30 min

	
A-Eurosurub 5x50 – 8 buc	H-Balama aplicata – 4buc
	
B-Capacele adezive -8 buc	I-Surub maner 25mm 4buc
	
C-Holtzsurub 4x16 – 12buc	J- Cuie Hdf – 20 buc
	
D-Holtzsurub 4x18 - 8buc	K-Cheita imbus 5x50 – 1 buc
	
E-Maner – 2 buc	L-Coltar L demontabil-2buc
	
F-Suport polita-4buc	M- diblu 10x60 – 2 buc
	
G-Holtzsurub 6x70 – 2 buc	

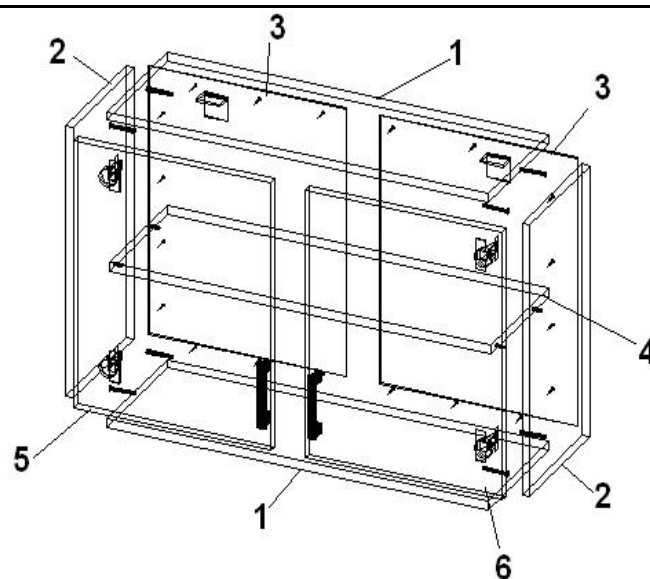

1 - Placa orizontala PAL – 2 bu 4 - Raft PAL - 1 buc  
2 - Laterala PAL – 2 buc 5 - Usa stanga - 1 buc  
3 - Spate HDF – 2 buc 6 - Usa dreapta - 1 buc

### Instructiuni de asamblare corp masca chiuveta 2 usi

1. Se cupleaza placile orizontale 1 intre lateralele 2 folosind 8 buc eurosuruburi A
2. Se prind, folosind cuie HDF J, placile spate HDF 3 de lateralele 2 si placile orizontale 1 prin batere cu ciocanul
3. Se monteaza coltarele demontabile L pe placa orizontala 1 in colturile corpului cu ajutorul holtzsuruburilor C
4. Se aseaza raftul 4 pe suportii polita F dupa introducerea lor in gaurile corespunzatoare din lateralele 2
5. Se monteaza balamalele H pe usile 5 si 6 cu ajutorul holtzsuruburilor D
6. Se monteaza bratul balamalelor H pe lateralele 2 cu ajutorul holtzsuruburilor C
7. Se monteaza manerele E pe usile 5 si 6 cu ajutorul suruburilor I
8. Se aplica capacelele adezive B pe fiecare eurosurub A
9. Se monteaza in perete la inaltimea dorita diblurile M folosind o nivela pentru asigurarea orizontalitatii
10. Se aseaza corpul pe pozitie si se fixeaza de perete cu holtzsuruburi G prin coltarele L in diblurile M montate deja in perete
11. La 24 de ore dupa montaj se strang din nou holtzsuruburile G in diblurile M pentru fixarea definitiva de perete







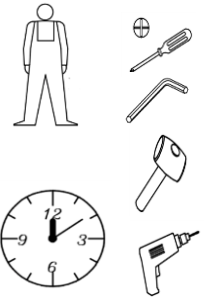
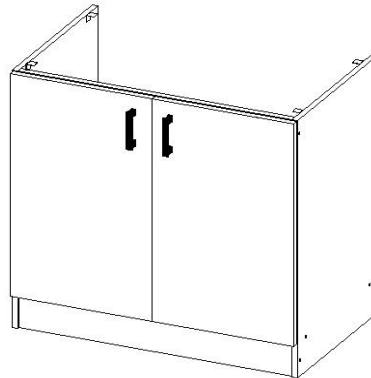



Va rugam sa verificati continutul coletului, existenta accesoriilor de feronerie, precum si a pieselor mentionate in schita de montaj. In cazul constatarii lipsurilor (feronerie, piese) sau defectiunilor va rugam sa anuntati personalul LUX ARTIM in termen de 24 ore de la achizitionarea produsului, comunicand lipsurile si defectiunile constatate si numarul stampilei C.T.C. de pe ambalaj. In cazul necomunicarii defectiunilor sau lipsurilor constatate in termenul de mai sus, SC LUX-ARTIM SRL nu-si asuma raspunderea pentru eventualele neconformitati.  
Va multumim pentru intelegere.

## START

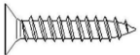
CORP MASCA CHIUVETA 2 USI 80x80x50  
VERSIUNEA: 01/30.04.2020



30 min

 <b>A</b> - Eurosurub 5x50 – 10 buc	 <b>F</b> -Balama aplicata-4buc
 <b>B</b> – Capacele adezive -10 buc	 <b>G</b> – Surub maner 25mm 4 buc
 <b>C</b> - Holtzsurub 4x16 – 16buc	 <b>H</b> - Holtzsurub 4x18 – 8buc
 <b>D</b> – Maner selectat – 2 buc	 <b>I</b> -Cheie imbus 6mm-1buc  <b>J</b> -Cheie imbus 5x50-1buc
 <b>E</b> -Picioar negru M6+bucsa-4 buc	 <b>K</b> – Coltar Zn 22x22 – 4 buc

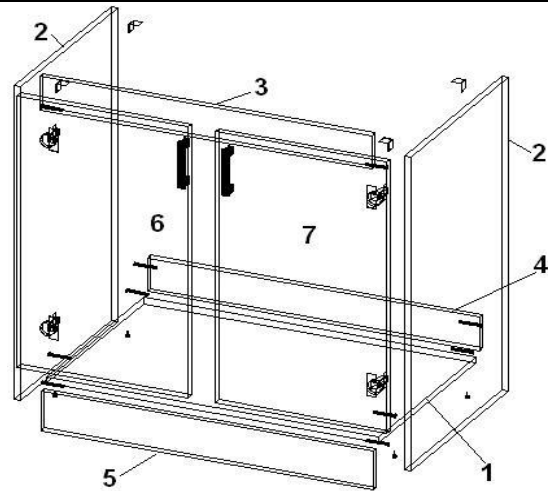

1 - Placa fund PAL – 1 buc	5 – Plinta PAL – 1 buc
2 - Laterala PAL – 2 buc	6 – Usa stanga – 1 buc
3 - Lonjeroan frontal PAL – 1 buc	7 – Usa dreapta – 1 buc
4 - Lonjeroan spate PAL - 1 buc	

### Instructiuni de asamblare corp masca chiuveta 2 usi

1. Se fixeaza cele 4 buc picioare E pe lateralele 2, folosind cheia imbus de 6mm I
2. Se cupleaza placa fund 1 cu lateralele 2 folosind 4 buc eurosuruburi A
3. Se monteaza lonjeroanele 3 si 4 intre lateralele 2 cu eurosuruburi A
4. Se monteaza plinta 5 intre lateralele 2 folosind 2 buc eurosuruburi A
5. Se monteaza balamalele F pe usile 6 si 7 fixandu-se cu ajutorul holtzsuruburilor H
6. Se monteaza bratul balamalelor F pe lateralele 2 cu ajutorul holtzsuruburilor C
7. Se fixeaza la nivel coltarele Zn K pe lateralele 2 cu holtzsuruburile C
8. Se monteaza manerele D pe usile 6 si 7 prin prindere cu suruburile G
9. Se aplica capacelele adezive B pe fiecare eurosurub A
10. Se aseaza corpul pe o suprafata orizontala si se regleaza usile din bratul balamalelor.



SC LUX-ARTIM SRL  
 STR.AVANTULUI NR.11,ONESTI,BACAU  
 TEL.:0234317940, office@luxartim.ro  
[www.luxartim.ro](http://www.luxartim.ro)

Va rugam sa verificati continutul coletului, existenta accesoriilor de feronerie, precum si a pieselor mentionate in schita de montaj. In cazul constatarii lipsurilor (feronerie, piese) sau defectiunilor va rugam sa anuntati personalul LUX ARTIM in termen de 24 ore de la achizitionarea produsului, comunicand lipsurile si defectiunile constatate si numarul stampilei C.T.C. de pe ambalaj. In cazul necomunicarii defectiunilor sau lipsurilor constatate in termenul de mai sus, SC LUX-ARTIM SRL nu-si asuma raspunderea pentru eventualele neconformitati. Va multumim pentru intelegere.

## START

CORP BAZA 2USI 80x80x50  
 VERSIUNEA: 01/30.04.2020

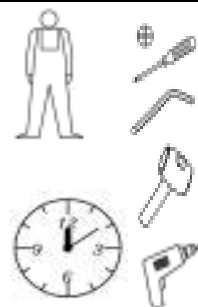
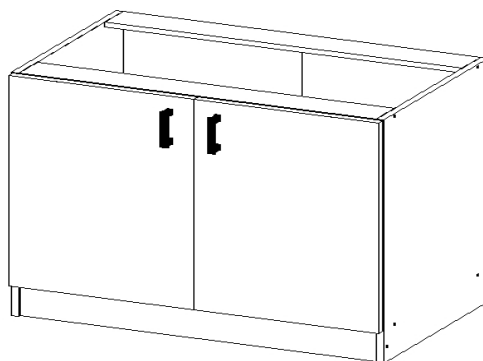

30 min

 A-Eurosurub 5x50 – 10 buc	 G-Balama aplicata – 4 buc
 B-Capacele adezive -10 buc	 H-Surub maner 25mm 4 buc
 C-Holtzsurub 4x16 – 8buc	 I – Cuie Hdf – 22 buc
 D-Picior negru M6+busca-4buc	 J-Cheie imbus 5x50-1buc
 E-Maner – 2 buc	 K-Holtzsurub 4x18 – 8buc
 F-Suport polita 4buc	 L-Cheie imbus 6mm-1buc

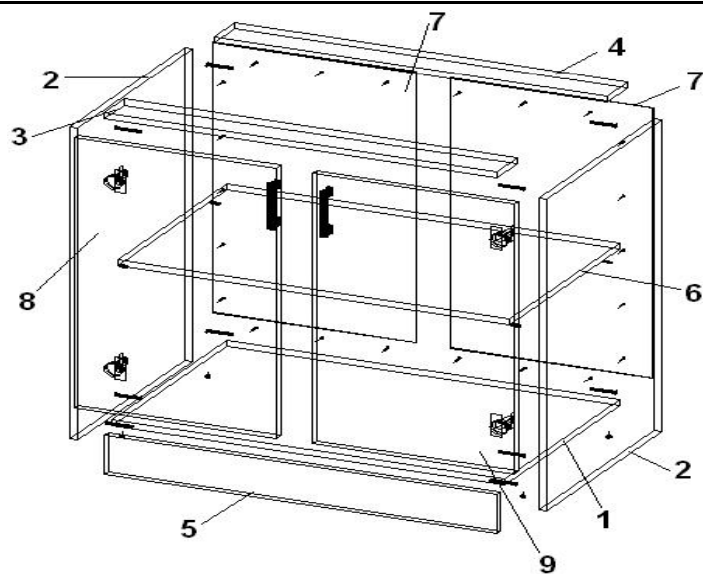

- |                                  |                         |
|----------------------------------|-------------------------|
| 1 - Placa fund PAL – 1 buc       | 6 – Raft PAL – 1 buc    |
| 2 - Laterala PAL – 2 buc         | 7 – Spate hdf – 2 buc   |
| 3 - Lonjeron frontal PAL – 1 buc | 8 - Usa stanga - 1 buc  |
| 4 - Lonjeron spate PAL - 1 buc   | 9 - Usa dreapta - 1 buc |
| 5 – Plinta PAL – 1 buc           |                         |

### Instructiuni de asamblare corp masca chiuveta 2 usi

1. Se fixeaza cele 4 buc picioare E pe lateralele 2, folosind cheia imbus de 6mm L
2. Se cupleaza placa fund 1 cu lateralele 2 folosind 4 buc eurosuruburi A
3. Se monteaza lonjeroanele 3 si 4 intre lateralele 2 cu eurosuruburi A
4. Se monteaza plinta 5 intre lateralele 2 folosind eurosuruburi A
5. Se prind cu tinte I cele doua placi spate hdf 7 de lateralele 2, placa fund 1 si lonjeronul 4 prin batere cu ciocanul
6. Se aseaza raftul 6 in corp dupa introducerea suportilor de polita F in gaurile corespunzatoare din lateralele 2
7. Se monteaza balamalele G pe usile 8 si 9 fixandu-se cu ajutorul holtzsuruburilor K
8. Se monteaza bratul balamalelor G pe lateralele 2 cu ajutorul holtzsuruburilor C
9. Se monteaza manerele E pe usile 8 si 9 prin prindere cu suruburile H
10. Se aplica capacelele adezive B pe fiecare eurosurub A
11. Se aseaza corpul pe o suprafata orizontala si se regleaza usile din bratul balamalelor