



SC LUX-ARTIM SRL
 STR.AVANTULUI NR.11,ONESTI,BACAU
 TEL.:0234317940, office@luxartim.ro
www.luxartim.ro







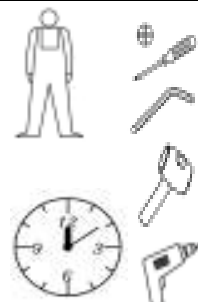
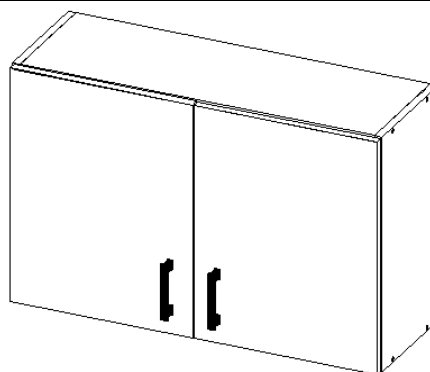



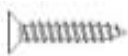

Va rugam sa verificati continutul coletului, existenta accesoriilor de feronerie, precum si a pieselor mentionate in schita de montaj. In cazul constatarii lipsurilor (feronerie, piese) sau defectiunilor va rugam sa anuntati personalul LUX ARTIM in termen de 24 ore de la achizitionarea produsului, comunicand lipsurile si defectiunile constatate si numarul stampilei C.T.C. de pe ambalaj. In cazul necomunicarii defectiunilor sau lipsurilor constatate in termenul de mai sus, SC LUX-ARTIM SRL nu-si asuma raspunderea pentru eventualele neconformitati. Va multumim pentru intelegere.

START

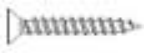
CORP SUSPENDAT 2USI 51x80x30
 VERSIUNEA: 01/30.04.2020

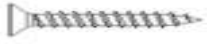

30 min

	
A-Eurosurub 5x50 – 8 buc	H-Balama aplicata – 4buc
	
B-Capacele adezive -8 buc	I-Surub maner 25mm 4buc
	
C-Holtzsurub 4x16 – 12buc	J- Cuie Hdf – 20 buc
	
D-Holtzsurub 4x18 - 8buc	K-Cheita imbus 5x50 – 1 buc
	
E-Maner – 2 buc	L-Coltar L demontabil-2buc
	
F-Suport polita-4buc	M- diblu 10x60 – 2 buc
	
G-Holtzsurub 6x70 – 2 buc	

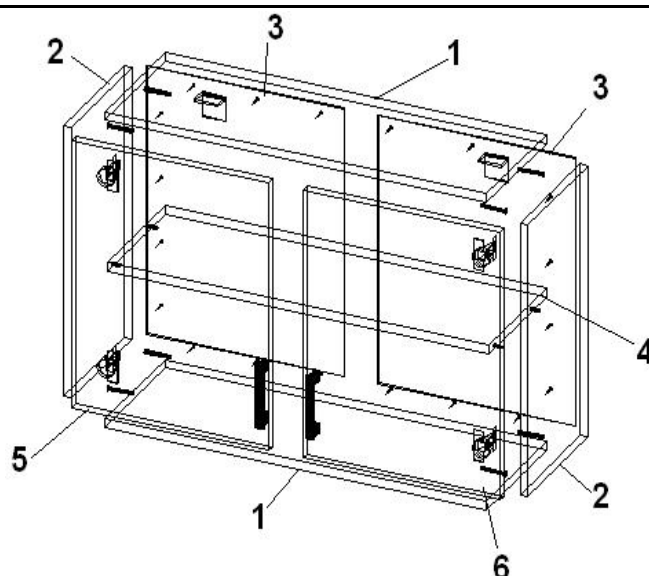

- 1 - Placa orizontala PAL – 2 bu
- 2 - Laterala PAL – 2 buc
- 3 - Spate HDF – 2 buc
- 4 - Raft PAL - 1 buc
- 5 - Usa stanga - 1 buc
- 6 - Usa dreapta - 1 buc

Instructiuni de asamblare corp masca chiuveta 2 usi

1. Se cupleaza placile orizontale 1 intre lateralele 2 folosind 8 buc eurosuruburi A
2. Se prind, folosind cuie HDF J, placile spate HDF 3 de lateralele 2 si placile orizontale 1 prin batere cu ciocanul
3. Se monteaza coltarele demontabile L pe placa orizontala 1 in colturile corpului cu ajutorul holtzsuruburilor C
4. Se aseaza raftul 4 pe suportii polita F dupa introducerea lor in gaurile corespunzatoare din lateralele 2
5. Se monteaza balamalele H pe usile 5 si 6 cu ajutorul holtzsuruburilor D
6. Se monteaza bratul balamalelor H pe lateralele 2 cu ajutorul holtzsuruburilor C
7. Se monteaza manerele E pe usile 5 si 6 cu ajutorul suruburilor I
8. Se aplica capacelele adezive B pe fiecare eurosurub A
9. Se monteaza in perete la inaltimea dorita diblurile M folosind o nivela pentru asigurarea orizontalitatii
10. Se aseaza corpul pe pozitie si se fixeaza de perete cu holtzsuruburi G prin coltarele L in diblurile M montate deja in perete
11. La 24 de ore dupa montaj se strang din nou holtzsuruburile G in diblurile M pentru fixarea definitiva de perete