

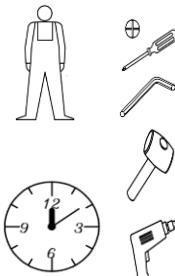

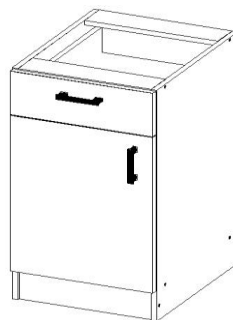









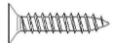

## START

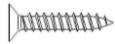
CORP BAZA 1SERTAR 1USA 80x40x50  
VERSIUNEA: 01/30.04.2020



30 min

Va rugam sa verificati continutul coletului, existenta accesoriilor de feronerie, precum si a pieselor mentionate in schita de montaj. In cazul constatarii lipsurilor (feronerie, piese) sau defectiunilor va rugam sa anuntati personalul LUX ARTIM in termen de 24 ore de la achizitionarea produsului, comunicand lipsurile si defectiunile constatate si numarul stampilei C.T.C. de pe ambalaj. In cazul necomunicarii defectiunilor sau lipsurilor constatate in termenul de mai sus, SC LUX-ARTIM SRL nu-si asuma raspunderea pentru eventualele neconformitati. Va multumim pentru intelegere.

	
A - Eurosurbub 5x50 – 18buc	H - Balama aplicata – 2buc
	
B - Holtzsurbub 3.5x16 – 20buc	I – Surub maner 4x40 2buc
	
C - Holtzsurbub 4x16 – 4buc	J - Cuie HDF - 28buc
	
D - Holtzsurbub 4x18 – 4 buc	K- Holtzsurbub 4x30 – 2 buc
	
E – Maner – 2buc	L-Glisiere 450mm-1set
	
F - Surub maner 25mm – 2 buc	M – Cheie imbus 6mm – 1buc N – Cheie imbus 5x50 – 1buc
	
G-Picior negru M6+busca-4buc	O – Capacele adezive -10 buc

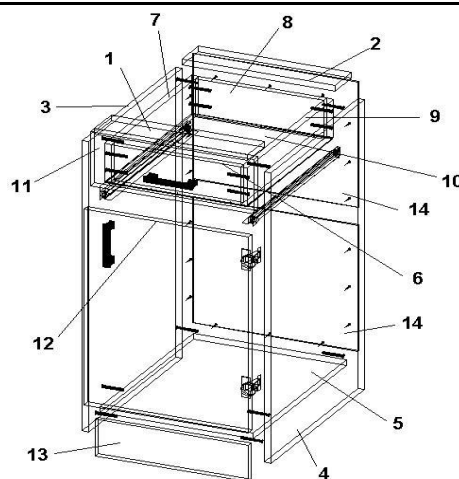

- |                        |                   |
|------------------------|-------------------|
| 1 -Lonjeron fata       | 8-Spate sertar    |
| 2-Lonjeron spate       | 9-Laterala sertar |
| 3-Laterala             | 10-Fund sertar    |
| 4-Laterala             | 11-Fata sertar    |
| 5-Placa fund           | 12-Usa            |
| 6-Fata interior sertar | 13-Plinta         |
| 7-Laterala sertar      | 14-Spate HDF 2buc |

### Instructiuni de asamblare corp masca chiuveta 2 usi

- Se fixeaza cele 4 buc picioare G pe lateralele 3 si 4, folosind cheia imbus de 6mm N
- Se cupleaza placa fund 5 cu lateralele 3 si 4 folosind 4buc eurosurbuburi A.
- Se monteaza lonjeroanele 1 si 2 intre lateralele 3 si 4 cu eurosurbuburi A.
- Se monteaza plinta 13 intre lateralele 3 si 4, folosind eurosurbuburi A.
- Se monteaza sinele de la glisierile L pe lateralele 3 si 4 cu holtzsurbuburile B.
- Se prind cele 2 placi spate Hdf 14 de lateralele 3 si 4, fundul 5 si lonjeronul 2 folosind cuie Hdf J.
- Se monteaza balamalele H pe usa 12 cu holtzsurbuburi D.
- Se monteaza bratul balamalelor H pe laterala 4 folosind holtzsurbuburi C.
- Se fixeaza manerul E pe usa 12 folosind suruburi F.
- Se cupleaza intre ele fata interior sertar 6, laterala sertar 7, spate sertar 8 si laterala 9 cu eurosurbuburi A.
- Se prinde fund sertar 10 de cadrul asamblat anterior, folosind cuie Hdf J.
- Se monteaza glisierile L pe lateralele sertarului 7 si 9 cu holtzsurbuburile B.
- Fata sertarului 11 se monteaza pe sertar, se fixeaza cu manerul E si suruburile I, apoi se fixeaza cu holtzsurbuburile K.
- Se aplica capacele autoadezive O pe toate eurosurbuburile vizibile.