

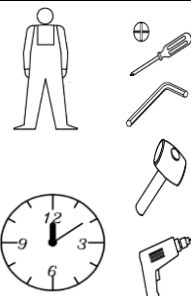

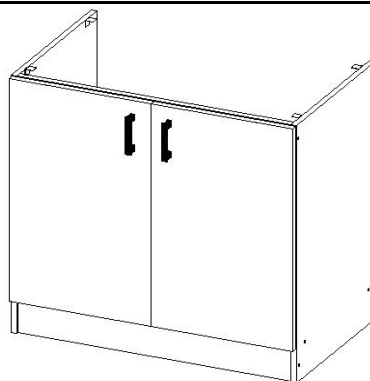







Va rugam sa verificati continutul coletului, existenta accesoriilor de feronerie, precum si a pieselor mentionate in schita de montaj. In cazul constatarii lipsurilor (feronerie, piese) sau defectiunilor va rugam sa anuntati personalul LUX ARTIM in termen de 24 ore de la achizitionarea produsului, comunicand lipsurile si defectiunile constatate si numarul stampilei C.T.C. de pe ambalaj. In cazul necomunicarii defectiunilor sau lipsurilor constatate in termenul de mai sus, SC LUX-ARTIM SRL nu-si asuma raspunderea pentru eventualele neconformitati.  
Va multumim pentru intelegere.

## START

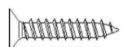
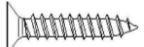
CORP MASCA CHIUVETA 2 USI 80x80x50  
VERSIUNEA: 01/30.04.2020



30 min

 A - Eurosurub 5x50 – 10 buc	 F-Balama aplicata-4buc
 B – Capacele adezive -10 buc	 G – Surub maner 25mm 4 buc
 C - Holtzsurub 4x16 – 16buc	 H - Holtzsurub 4x18 – 8buc
 D – Maner selectat – 2 buc	 I-Cheie imbus 6mm-1buc  J-Cheie imbus 5x50-1buc
 E-Picior negru M6+bucsa-4 buc	 K – Coltar Zn 22x22 – 4 buc

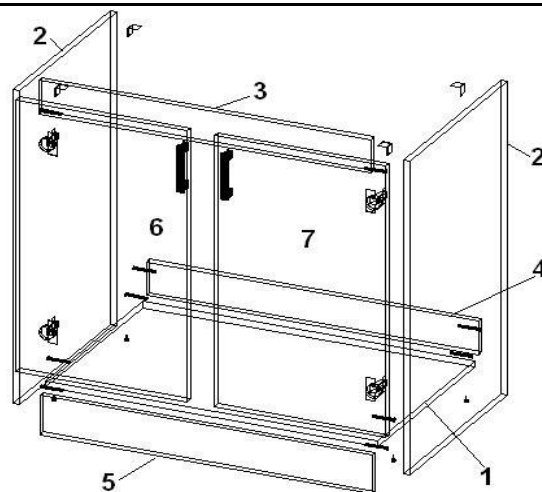

1 - Placa fund PAL – 1 buc	5 – Plinta PAL – 1 buc
2 - Laterala PAL – 2 buc	6 – Usa stanga – 1 buc
3 - Lonjeron frontal PAL – 1 buc	7 – Usa dreapta – 1 buc
4 - Lonjeron spate PAL - 1 buc	

### Instructiuni de asamblare corp masca chiuveta 2 usi

1. Se fixeaza cele 4 buc picioare E pe lateralele 2, folosind cheia imbus de 6mm I
2. Se cupleaza placa fund 1 cu lateralele 2 folosind 4 buc eurosuruburi A
3. Se monteaza lonjeroanele 3 si 4 intre lateralele 2 cu eurosuruburi A
4. Se monteaza plinta 5 intre lateralele 2 folosind 2 buc eurosuruburi A
5. Se monteaza balamalele F pe usile 6 si 7 fixandu-se cu ajutorul holtzsuruburilor H
6. Se monteaza bratul balamalelor F pe lateralele 2 cu ajutorul holtzsuruburilor C
7. Se fixeaza la nivel coltarele Zn K pe lateralele 2 cu holtzsuruburile C
8. Se monteaza manerele D pe usile 6 si 7 prin prindere cu suruburile G
9. Se aplica capacelele adezive B pe fiecare eurosurub A
10. Se aseaza corpul pe o suprafata orizontala si se regleaza usile din bratul balamalelor.