

Va rugam sa verificati continutul coletului, existenta accesoriilor de feronerie, precum si a pieselor mentionate in schita de montaj. In cazul constatarii lipsurilor (feronerie, piese) sau defectiunilor va rugam sa anuntati personalul LUX ARTIM in termen de 24 ore de la achizitionarea produsului, comunicand lipsurile si defectiunile constatate si numarul stampilei C.T.C. de pe ambalaj. In cazul necomunicarii defectiunilor sau lipsurilor constatate in termenul de mai sus, SC LUX-ARTIM SRL nu-si asuma raspunderea pentru eventualele neconformitati. Va multumim pentru intelegere.

DOMINO - D3

CORP BAZA 1SERTAR 1USA 82x40x53
VERSIUNEA: 01/1.10.2020

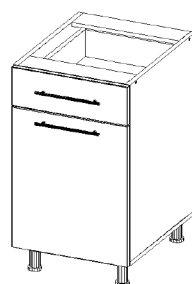

















X1



45 min



 A - Eurosurub 5x50 - 8 buc B - Eurosurub 7x50 - 1 buc	 I - Surub maner 4x25 - 2 buc
 C - Capacele adezive - 4 buc	 J - Suporti de polita - 4 buc
 D - Balama aplicata - 2 buc	 K - Cuie HDF - 30 buc
 E - Holtzsurub 3,5x16 - 24 buc	 L - Cheie imbus 5x50 - 1 buc  M - Cheie imbus 7x50 - 1 buc
 F - Maner - 2 buc	 N - Set metalbox - 1 set
 G - Holtzsurub 4x25 - 2 buc	 O - Surub maner 4x20 - 2 buc
 H - Picior plastic reglabil-4 buc	 P - Holtzsurub 4x16 - 28 buc
 Q - Amortizor si placuta amortizare	

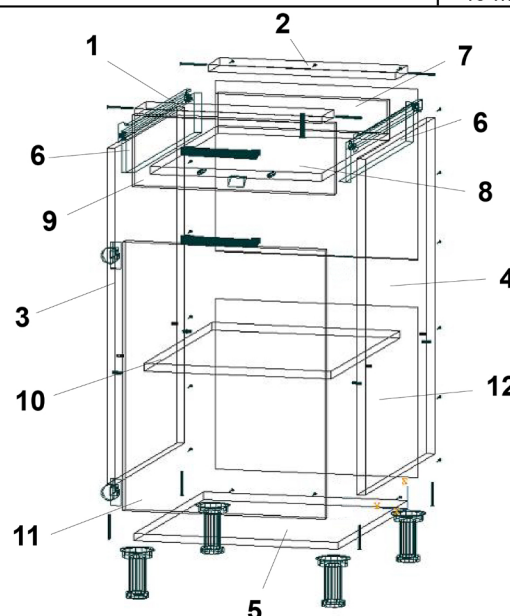

- | | |
|------------------------------|----------------------|
| 1 - Lonjeron fata | 7 - Spate sertar |
| 2 - Lonjeron spate | 8 - Fund sertar |
| 3 - Laterală stanga | 9 - Fata sertar |
| 4 - Laterală dreapta | 10 - Raft |
| 5 - Placa de baza | 11 - Usa |
| 6 - Laterale metalbox sertar | 12 - Spate HDF 2 buc |

Instructiuni de asamblare corp baza 1 sertar 1 usa

- 1 - Se monteaza 4 buc picior plastic H pe placa de baza 5 cu holtzsuruburile E.
- 2 - Se monteaza sinele de la seturile metalbox N pe lateralele 3 si 4 cu holtzsuruburi E.
- 3 - Se cupleaza placa de baza 5 cu lateralele 3 si 4 folosind eurosuruburi A.
- 4 - Se monteaza lonjeroanele 1 si 2 intre lateralele 3 si 4 cu eurosuruburi A.
- 5 - Se prind cu cuie Hdf placile spate Hdf 12 de lateralele 3 si 4, placa de baza 5 si lonjeron spate 2.
- 6 - Se monteaza balamalele D pe usa 11 si pe lateralele 3 si 4 cu eurosuruburi E.
- 7 - Se strapung gaurile de maner din interior spre exterior cu un burghiu de 4,8. Se fixeaza manerul F pe usa 11 folosind surub maner O.
- 8 - Se aseaza raftul 10 pe suportii de polita J, dupa introducerea lor in gaurile corespunzatoare din lateralele 3 si 4.
- 9 - Se monteaza sertarul cupland lateralele metalbox 6 de fundul sertarului 8 cu holtzsuruburi E. Intre laterale se monteaza spate sertar 7 cu holtzsuruburi E. Placa fund 8 se prinde de spate sertar 7 cu eurosurub B.
Pe laterala stanga se prinde amortizorul Q, iar placuta amortizare se prinde pe fundul sertarului 8, in partea stanga, pe punctare, cu holtzsuruburi G.
- 10 - Fata sertarului 9 se monteaza pe sertar si se fixeaza cu holtzsuruburile P, dupa care se fixeaza manerul F cu suruburile I.
- 11 - Se aplica capacele autoadezive C pe toate eurosuruburile A vizibile.