

Va rugam sa verificati continutul coletului, existenta accesoriilor de feronerie, precum si a pieselor mentionate in schita de montaj. In cazul constatarii lipsurilor (feronerie, piese) sau defectiunilor va rugam sa anuntati personalul LUX ARTIM in termen de 24 ore de la achizitionarea produsului, comunicand lipsurile si defectiunile constatate si numarul stampilei C.T.C. de pe ambalaj. In cazul necomunicarii defectiunilor sau lipsurilor constatate in termenul de mai sus, SC LUX-ARTIM SRL nu-si asuma raspunderea pentru eventualele neconformitati. Va multumim pentru intelegere.

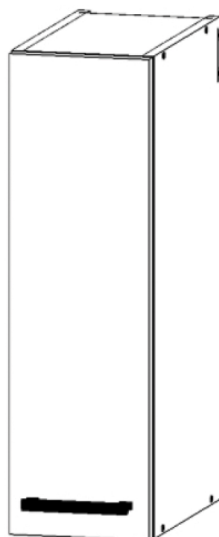







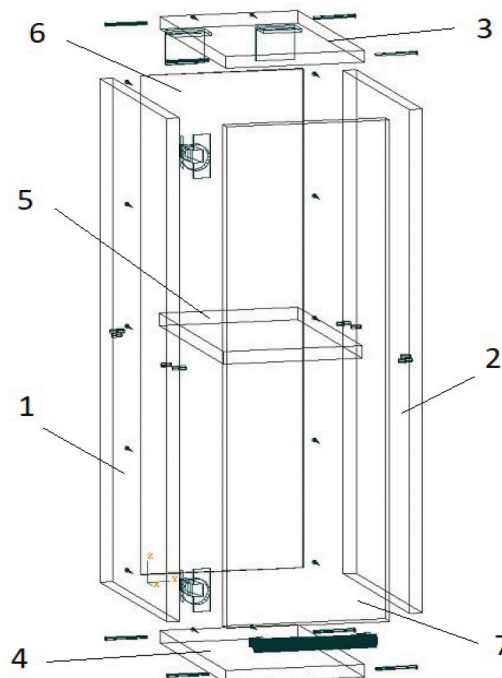



## DOMINO - D21

CORP SUSPENDAT 1USA 1RAFT 20X65X32.1



30min



			
A-eurosurub 5x50 - 8buc	D-cuie HDF - 14buc	G- suport polita - 4buc	J – Holtzsurub 6x70 – 2 buc
			
B-capacele autoadezive-8buc	E-holtzsurub 4x16 - 12buc	H-Coltar L demontabil-2 buc	K-balama -2buc
			
C-cheie imbus 5x50- 1buc	F - Maner – 1 buc	I-Surub maner - 2buc	L – Diblu 10x60 – 2 buc

1-Laterala stanga-1buc

4-Placa baza-1buc

7-Usa -1buc

2-Laterala dreapta-1buc

5-Raft-1buc

3-Capac interior - 1buc

6-Spate HDF - 1buc

1. Se cupleaza lateralele 1 si 2 cu capac 3 si placa baza 4 folosind eurosuruburi A;

2. Se prinde spatele HDF 6 cu tinte HDF D, prin batere cu ciocanul pe cadrul format de lateralele 1 si 2, capac 3 si placa baza 4

3. Se monteaza balamalele K pe usa 7 cu holtzsuruburi E, apoi se fixeaza pe laterala 2 cu holtzsuruburi E

4. Se prinde manerul F pe usa 7 cu suruburile I

5. Se aseaza raftul 5 pe suportii de polita G dupa introducerea lor in gaurile corespunzatoare din lateralele 1 si 2

6. Pentru fixarea corpului de perete sunt folosite 2 coltare "L" demontabile H prinse in partea superioara pe placa capac 3 cu holtzsuruburi E, iar in perete cu dibluri L si holtzsuruburi J

7. Pentru mascarea eurosuruburilor vizibile A se folosesc capacele albe autoadezive B.