

Va rugam sa verificati continutul coletului, existenta accesoriilor de feronerie, precum si a pieselor mentionate in schita de montaj. In cazul constatarii lipsurilor (feronerie, piese) sau defectiunilor va rugam sa anuntati personalul LUX ARTIM in termen de 24 ore de la achizitionarea produsului, comunicand lipsurile si defectiunile constatate si numarul stampilei C.T.C. de pe ambalaj. In cazul necomunicarii defectiunilor sau lipsurilor constatate in termenul de mai sus, SC LUX-ARTIM SRL nu-si asuma raspunderea pentru eventualele neconformitati. Va multumim pentru intelegere.

DOMINO - D1
MASCA CHIUVETA 2USI 80x82x53
VERSIUNEA: 01/02.10.2010











X2



30 min

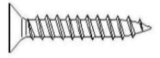

| | |
|---|---|
|  A - Eurosurub 5x50 – 8 buc |  G - Balama aplicata – 4 buc |
|  B-Capacele adezive – 4 buc |  H – Surub maner – 4 buc |
|  C-Picior plastic reglabil-4 buc |  I – Coltar Zn 40x40– 4 buc |
|  D-Holtzsurub 4x16 – 48 buc |  F – Cheita inbus 5x50 – 1 buc |
|  E –Maner – 2 buc | |

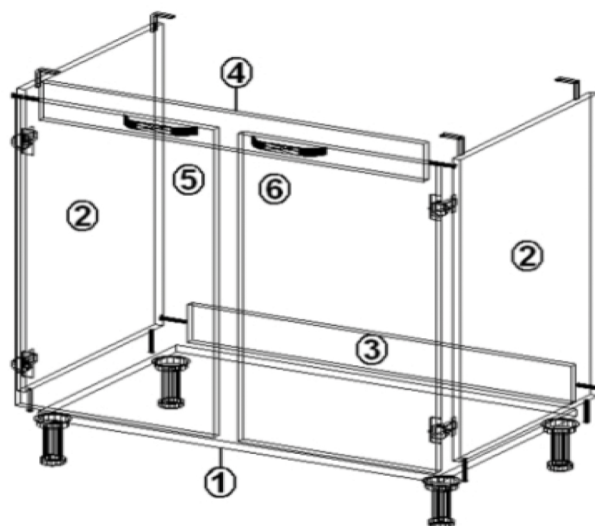

- 1 - Placa de baza PAL – 1 buc
- 2 - Laterala PAL – 2 buc
- 3 - Lonjeron spate PAL – 1 buc
- 4 - Lonjeron frontal PAL - 1 buc
- 5 - Usa stanga - 1 buc
- 6 - Usa dreapta - 1 buc

Instructiuni de asamblare corp masca chiuveta 2 usi

1. Se fixeaza cele 4 buc picioare C pe placa de baza 1 cu ajutorul holtzsuruburilor D la 4 cm de margine
2. Se cupleaza placa de baza 1 cu lateralele 2 folosind 4 buc eurosuruburi A
3. Se monteaza lonjeroanele 3 si 4 intre lateralele 2 cu eurosuruburi A
4. Se monteaza balamalele G pe usile 5 si 6 si pe lateralele 2 cu ajutorul holtzsuruburilor D
5. Se monteaza manerele E pe usile 5 si 6 cu ajutorul suruburilor H, prin strapungerea gaurilor de maner din interior spre exterior
6. Pentru mascarea eurosuruburilor vizibile A se folosesc capacele albe autoadezive B.

* Optional: pentru fixarea blatului se vor folosi 4 coltare I prinse cu holtzsuruburi D