

Va rugam sa verificati continutul coletului, existenta accesoriilor de feronerie, precum si a pieselor mentionate in schita de montaj. In cazul constatarii lipsurilor (feronerie, piese) sau defectiunilor va rugam sa anuntati personalul LUX ARTIM in termen de 24 ore de la achizitionarea produsului, comunicand lipsurile si defectiunile constatate si numarul stampilei C.T.C. de pe ambalaj. In cazul necomunicarii defectiunilor sau lipsurilor constatate in termenul de mai sus, SC LUX-ARTIM SRL nu-si asuma raspunderea pentru eventualele neconformitati. Va multumim pentru intelegere.

DOMINO - D8

CORP SUSPENDAT 2USI 80x65x32.1
VERSIUNEA: 1/1.10.2020

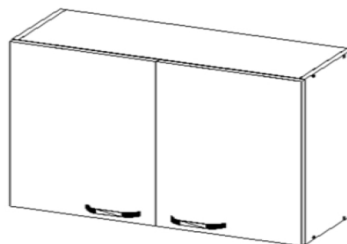

X2



30 min



A - Eurosurub 5x50 – 8 buc



H - Balama aplicata – 4 buc



B – Capacele adezive -8 buc



I – Surub maner – 4 buc



C - Holtzsurub 6x70– 2 buc



J - Suporti de polita – 4 buc

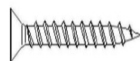

D – Holtzsurub 4x16 – 20 buc



K - Cuie HDF – 22 buc



E - Maner – 2 buc



L – Cheita imbus – 1 buc



F – Diblu 10x60 – 2 buc



M – Coltar L demontabil – 2 buc

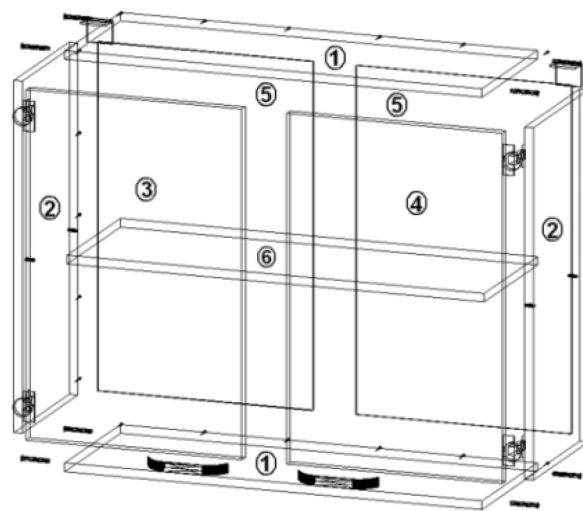

- 1 - Placa orizontala – 2 buc
- 2 - Laterala PAL – 2 buc
- 3 - Usa stanga – 1 buc
- 4 - Usa dreapta – 1 buc
- 5 - Spate hdf – 2 buc
- 6 - Raft - 1 buc

Instructiuni de asamblare corp suspendat 2 usi

1. Se cupleaza lateralele 2 cu placile orizontale 1 folosind 8 buc eurosuruburi A
2. Se prind cu tinte K placile spate hdf 5 pe lateralele 2 si placile orizontale 1 prin batere cu ciocanul verificand ca diagonalele carcusei sa fie egale
3. Se monteaza balamalele H pe usile 3 si 4 cu holtzsuruburi D, apoi se fixeaza pe lateralele 2 cu holtzsuruburi D
4. Se prind manerele E pe usile 3 si 4 cu suruburile I
5. Se aseaza raftul 6 pe suportii de polita J dupa introducerea lor in gaurile corespunzatoare din lateralele 2
6. Pentru fixarea corpului de perete sunt folosite 2 coltare "L" demontabile M prinse in partea superioara pe placa 1 cu holtzsuruburi D, iar in perete cu dibluri F si holtzsuruburi C
7. Pentru mascarea eurosuruburilor vizibile A se folosesc capacele albe autoadezive B.

Va rugam sa verificati continutul coletului, existenta accesoriilor de feronerie, precum si a pieselor mentionate in schita de montaj. In cazul constatarii lipsurilor (feronerie, piese) sau defectiunilor va rugam sa anuntati personalul LUX ARTIM in termen de 24 ore de la achizitionarea produsului, comunicand lipsurile si defectiunile constatate si numarul stampilei C.T.C. de pe ambalaj. In cazul necomunicarii defectiunilor sau lipsurilor constatate in termenul de mai sus, SC LUX-ARTIM SRL nu-si asuma raspunderea pentru eventualele neconformitati. Va multumim pentru intelegere.

DOMINO - D9

CORP SUSPENDAT 2USI STICLA 80x65x32
VERSIUNEA: 01/1.10.2020















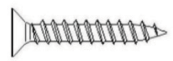

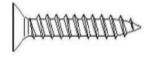
X2



30 min



	
A - Eurosurbub 5x50 – 12 buc	H - Balama aplicata – 2 buc
	
B – Capacele adezive -12 buc	I – Surub maner – 4 buc
	
C - Holtzsurub 3.5x16 – 16 buc	J - Balama semiaplicata - 2 buc
	
D – Holtzsurub 4x16 – 20 buc	K -Cuie HDF – 24 buc
	
E - Maner – 2 buc	L – Cheita imbus – 1 buc
	
F – Diblu 10x60 – 2 buc	M - Coltar L demontabil – 2 buc
	
G – Holtzsurub 6x70 – 2 buc	N - Telescop gaz - 4 buc

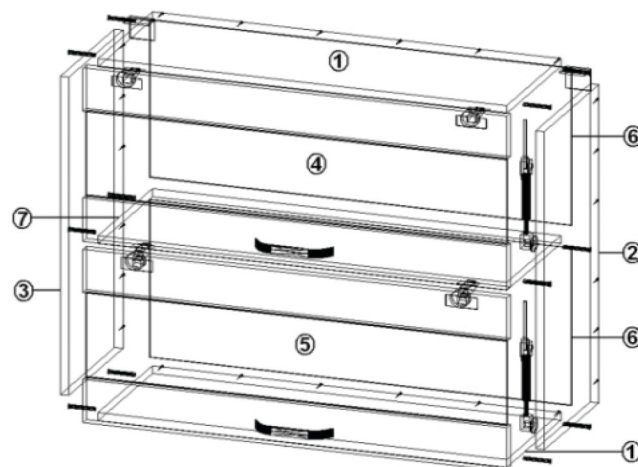

- 1 - Placa orizontala - 2 buc
- 2 - Laterala dreapta PAL - 1 buc
- 3 - Laterala stanga PAL - 1 buc
- 4 - Usa superioara - 1 buc
- 5 - Usa inferioara - 1 buc
- 6 - Spate HDF - 2 buc
- 7 - Raft PAL - 1 buc

Instructiuni de asamblare corp suspendat 2 usi sticla

1. Se cupleaza lateralele **2** si **3** cu placile orizontale **1** folosind 8 buc eurosurbuburi **A**
2. Se fixeaza raftul **7** intre lateralele **2** si **3** cu 4 buc eurosurbuburi **A**
3. Se prind cu tinte **K** placile spate hdf **6** pe lateralele **2** si **3** si placile orizontale **1** prin batere cu ciocanul
4. Se monteaza balamalele **H** pe usa **4** cu holtzsuruburi **C**, apoi se fixeaza pe placa orizontala superioara **1** cu holtzsuruburi **D**
5. Se monteaza balamalele **J** pe usa **5** cu holtzsuruburi **C**, apoi se fixeaza pe raftul **7** cu holtzsuruburi **D**
6. Montarea tuburilor de gaz **N** se face intre usa **4** si lateralele dreapta **2** si stanga **3**, respectiv usa **5** si lateralele dreapta **2** si stanga **3** cu ajutorul holtzsuruburilor **D**
7. Se prind manerele **E** pe usile **4** si **5** cu suruburile **I**, prin strapungerea gaurilor din interior spre exterior
8. Pentru fixarea corpului de perete sunt folosite 2 coltare L demontabile **M** prinse in partea superioara pe placa **1** cu holtzsuruburi **D**, iar in perete cu dibluri **F** si holtzsuruburi **G**
9. Pentru mascarea eurosurbuburilor vizibile **A** se folosesc capacele albe autoadezive **B**.

Va rugam sa verificati continutul coletului, existenta accesoriilor de feronerie, precum si a pieselor mentionate in schita de montaj. In cazul constatarii lipsurilor (feronerie, piese) sau defectiunilor va rugam sa anuntati personalul LUX ARTIM in termen de 24 ore de la achizitionarea produsului, comunicand lipsurile si defectiunile constatate si numarul stampilei C.T.C. de pe ambalaj. In cazul necomunicarii defectiunilor sau lipsurilor constatate in termenul de mai sus, SC LUX-ARTIM SRL nu-si asuma raspunderea pentru eventualele neconformitati. Va multumim pentru intelegere.

DOMINO - D10

CORP HOTA 60x50x32.1
VERSIUNEA: 1/01.10.2020

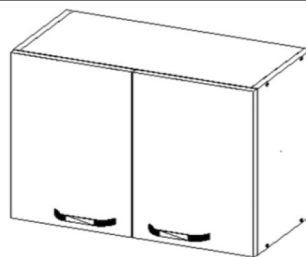

X2



30 min



A - Eurosurub 5x50 – 8 buc



H - Balama aplicata – 4 buc



B – Capacele adezive -8 buc



I – Surub maner – 4 buc



C - Holtzsurub 6x70 – 2 buc



J – Coltar L demontabil – 2 buc

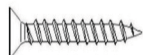

D – Holtzsurub 4x16 – 20 buc



K - Cuie HDF – 16 buc



E - Maner – 2 buc



L – Cheita inbus – 1 buc



F – Diblu 10x60 – 2 buc

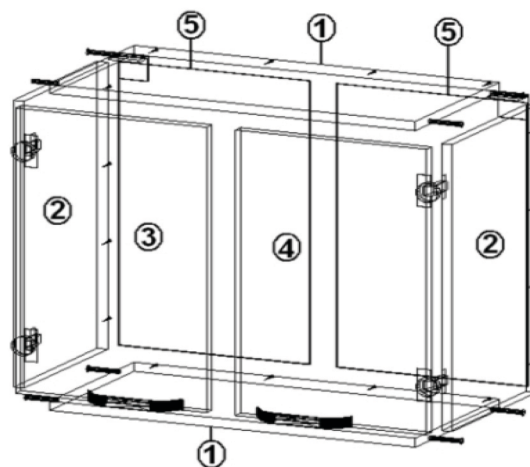

1 - Placa orizontala - 2 buc
2 - Laterală PAL - 2 buc
3 - Usa stanga - 1 buc
4 - Usa dreapta - 1 buc
5 - Spate HDF - 2 buc

Instructiuni de asamblare corp hota

1. Se cupleaza lateralele 2 cu placile orizontale 1 folosind 8 buc eurosuruburi A
2. Se prind cu tinte K placile spate hdf 5 pe lateralele 2 si placile orizontale 1 prin batere cu ciocanul verificand ca diagonalele carcasei sa fie egale
3. Se monteaza balamalele H pe usile 3 si 4 cu holtzsuruburi D, apoi se fixeaza pe lateralele 2 cu holtzsuruburi D
4. Se prind manerele E pe usile 3 si 4 cu suruburile I
5. Pentru fixarea corpului de perete sunt folosite 2 coltare L demontabile J prinse in partea superioara pe placa 1 cu holtzsuruburi D, iar in perete cu dibluri F si holtzsuruburi C
6. Pentru mascarea eurosuruburilor vizibile A se folosesc capacele albe autoadezive B.

DOMINO - D12

CORP BAZA 3SERTARE 60X82x53
VERSIUNEA: 01/1.10.2020

Va rugam sa verificati continutul coletului, existenta accesoriilor de feronerie, precum si a pieselor mentionate in schita de montaj. In cazul constatarii lipsurilor (feronerie, piese) sau defectiunilor va rugam sa anuntati personalul LUX ARTIM in termen de 24 ore de la achizitionarea produsului, comunicand lipsurile si defectiunile constatate si numarul stampilei C.T.C. de pe ambalaj. In cazul necomunicarii defectiunilor sau lipsurilor constatate in termenul de mai sus, SC LUX-ARTIM SRL nu-si asuma raspunderea pentru eventualele neconformitati. Va multumim pentru intelegere.

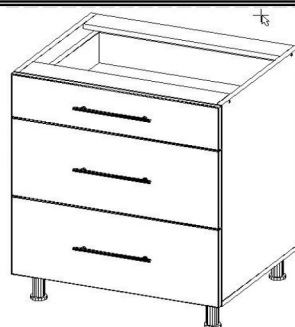











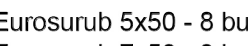

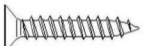
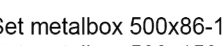

X2

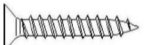

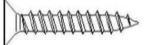
30 min



	
A - Eurosurub 5x50 - 8 buc	I - Maner - 3 buc
	
B - Eurosurub 7x50 - 3 buc	J - Surub maner 4x25 - 6 buc
	
C - Capacele adezive - 4 buc	K1 - Set metalbox 500x86-1 set
	
D - Holtzsurub 4x30 - 6 buc	K2 - Set metalbox 500x150-2 seturi
	
E - Holtzsurub 4x16 - 32 buc	L - Cheie imbus 5x50 - 1 buc
	
F - Holtzsurub 3,5x16 - 90 buc	M - Cheie imbus 7x50 - 1 buc
	
G - Holtzsurub 4x25 - 12 buc	N - Cuie HDF - 34 buc
	
H - Picior plastic reglabil - 4 buc	O - Amortizor si placuta amortizare - 3 buc

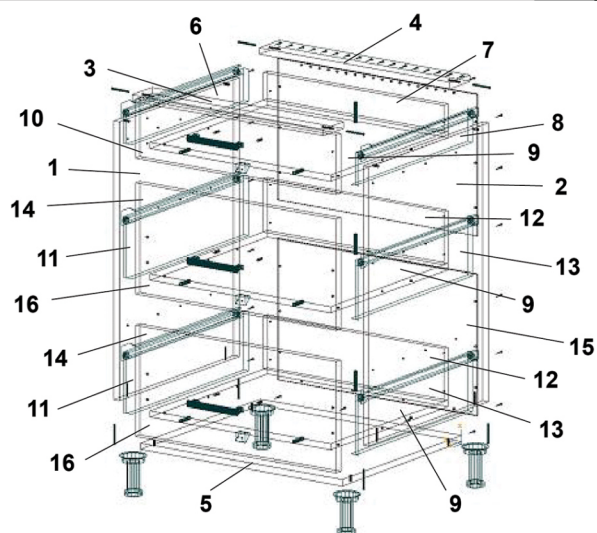

1 - Laterală stanga	9 - Baza sertar 3 buc
2 - Laterală dreapta	10 - Fata exterior sertar
3 - Lonjeron fata	11 - Laterală stanga metalbox sertar 2 buc
4 - Lonjeron spate	12 - Spate sertar 2 buc
5 - Placa de baza	13 - Laterală dreapta metalbox sertar 2 buc
6 - Laterală stanga metalbox sertar	14 - Fata exteriora sertar 2 buc
7 - Spate sertar	15 - Spate HDF 2 buc
8 - Laterală dreapta metalbox sertar	

Instructiuni de asamblare corp baza 3 sertare

- 1 - Se monteaza picioarele de plastic H pe placa de baza 5 cu holtzsuruburile E.
- 2 - Se cupleaza placa de baza 5 cu lateralele 1 si 2 folosind eurosuruburi A.
- 3 - Se monteaza lonjeroanele 3 si 4 intre lateralele 1 si 2 cu eurosuruburi A.
- 4 - Se prind placile spate HDF 15 de lateralele 1 si 2, placa de baza 5 si lonjeron spate 4, folosind cuie HDF N.
- 5 - Se monteaza sinele de la seturile metalbox K pe lateralele 1 si 2 cu holtzsuruburi F.
- 6 - Se monteaza sertarul cupland lateralele metalbox 6 de fundul sertarului 8 cu holtzsuruburi F. Intre laterale se monteaza spate sertar 7 cu holtzsuruburi E. Placa fund 8 se prinde de spate sertar 7 cu eurosurub B.
- 7 - Pe laterala stanga se prinde amortizorul O, iar placuta amortizare se prinde pe fundul sertarului 8, in partea stanga, pe punctare, cu holtzsuruburi G.
- 8 - Fata sertarului 10 si 14 se monteaza pe sertar si se fixeaza manerul I cu suruburile J.
- 9 - Se aplica capacele autoadezive C pe toate eurosuruburile A vizibile.

Va rugam sa verificati continutul coletului, existenta accesoriilor de feronerie, precum si a pieselor mentionate in schita de montaj. In cazul constatarii lipsurilor (feronerie, piese) sau defectiunilor va rugam sa anuntati personalul LUX ARTIM in termen de 24 ore de la achizitionarea produsului, comunicand lipsurile si defectiunile constatate si numarul stampilei C.T.C. de pe ambalaj. In cazul necomunicarii defectiunilor sau lipsurilor constatate in termenul de mai sus, SC LUX-ARTIM SRL nu-si asuma raspunderea pentru eventualele neconformitati. Va multumim pentru intelegere.

DOMINO - D13

CORP SUPERIOR 2 USI 60x65X32.1
VERSIUNEA: 1/01.10.2020

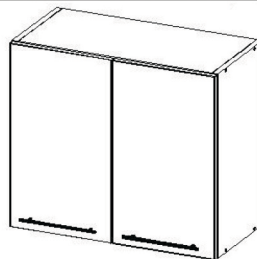

X2



30 min



A - Eurosurub 5x50 – 8 buc



G – Cheita imbus 5x50 – 1 buc



B – Capacele adezive -8 buc



H - Balama aplicata – 4 buc



C – Holtzsurub 6x70 – 2 buc



I – Surub maner 4x20 – 4 buc

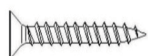

D – Holtzsurub 4x16 – 20 buc



J - Suporti de polita – 4 buc



E - Maner – 2 buc



K - Cuie HDF – 22 buc



F – Diblu 10x60 – 2 buc



L – Coltar L demontabil alb– 2 buc

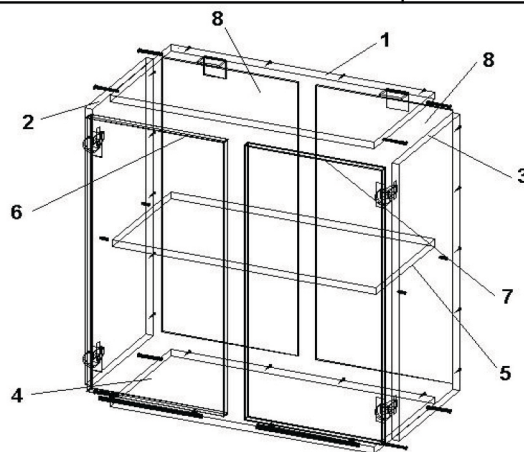

1 - Capac
2 - Laterala stanga
3 - Laterala dreapta
4 - Placa de baza
5 - Raft
6 - Usa stanga

7 - Usa dreapta
8 - Spate HDF 2 buc

- 1 - Se fixeaza placa de baza 4 de lateralele 2 si 3 cu eurosuruburi A.
- 2 - Se fixeaza placa capac 1 de lateralele 2 si 3 cu eurosuruburi A.
- 3 - Se prind cele 2 bucati spate Hdf 8 de lateralele 2 si 3, placa de baza 4 si capac 1, folosind cuie Hdf K.
- 4 - Se introduc suportii de polita J in gaurile de pe lateralele 2 si 3 si se aseaza raftul 5.
- 5 - Se prind pe usile 6 si 7 balamalele H cu holtzsuruburile D.
- 6 - Se fixeaza bratul balamalei H pe lateralele 2 si 3 cu holtzsuruburile D.
- 7 - Se prind manerele E pe usile 6 si 7 cu suruburile I.
- 8 - De placa capac 1 se prind coltarele demontabile L folosind holtzsuruburi D, apoi se fixeaza pe perete folosind diblurile F si holtzsuruburile C.
- 9 - Pe eurosuruburile A vizibile se lipest capacele adezive B.

Va rugam sa verificati continutul coletului, existenta accesoriilor de feronerie, precum si a pieselor mentionate in schita de montaj. In cazul constatarii lipsurilor (feronerie, piese) sau defectiunilor va rugam sa anuntati personalul LUX ARTIM in termen de 24 ore de la achizitionarea produsului, comunicand lipsurile si defectiunile constatate si numarul stampilei C.T.C. de pe ambalaj. In cazul necomunicarii defectiunilor sau lipsurilor constatate in termenul de mai sus, SC LUX-ARTIM SRL nu-si asuma raspunderea pentru eventualele neconformitati. Va multumim pentru intelegere.

DOMINO - D1
MASCA CHIUVETA 2USI 80x82x53
VERSIUNEA: 01/02.10.2010











X2



30 min

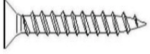

 A - Eurosurub 5x50 – 8 buc	 G - Balama aplicata – 4 buc
 B-Capacele adezive – 4 buc	 H – Surub maner – 4 buc
 C-Picior plastic reglabil-4 buc	 I – Coltar Zn 40x40– 4 buc
 D-Holtzsurub 4x16 – 48 buc	 F – Cheita inbus 5x50 – 1 buc
 E –Maner – 2 buc	

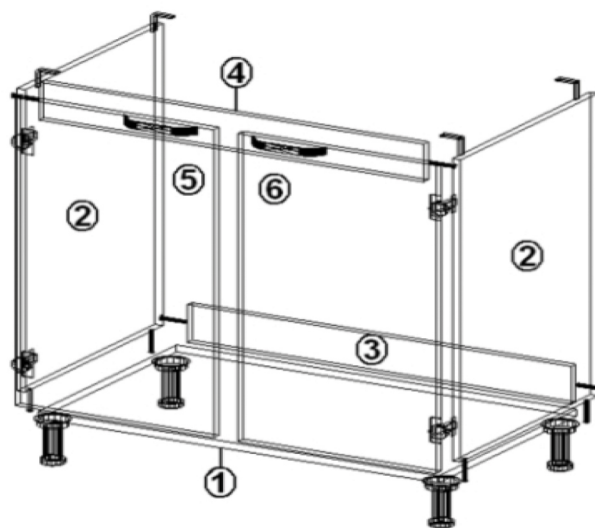

- 1 - Placa de baza PAL – 1 buc
- 2 - Laterala PAL – 2 buc
- 3 - Lonjeron spate PAL – 1 buc
- 4 - Lonjeron frontal PAL - 1 buc
- 5 - Usa stanga - 1 buc
- 6 - Usa dreapta - 1 buc

Instructiuni de asamblare corp masca chiuveta 2 usi

1. Se fixeaza cele 4 buc picioare C pe placa de baza 1 cu ajutorul holtzsuruburilor D la 4 cm de margine
2. Se cupleaza placa de baza 1 cu lateralele 2 folosind 4 buc eurosuruburi A
3. Se monteaza lonjeroanele 3 si 4 intre lateralele 2 cu eurosuruburi A
4. Se monteaza balamalele G pe usile 5 si 6 si pe lateralele 2 cu ajutorul holtzsuruburilor D
5. Se monteaza manerele E pe usile 5 si 6 cu ajutorul suruburilor H, prin strapungerea gaurilor de maner din interior spre exterior
6. Pentru mascarea eurosuruburilor vizibile A se folosesc capacele albe autoadezive B.

* Optional: pentru fixarea blatului se vor folosi 4 coltare I prinse cu holtzsuruburi D

Va rugam sa verificati continutul coletului, existenta accesoriilor de feronerie, precum si a pieselor mentionate in schita de montaj. In cazul constatarii lipsurilor (feronerie, piese) sau defectiunilor va rugam sa anuntati personalul LUX ARTIM in termen de 24 ore de la achizitionarea produsului, comunicand lipsurile si defectiunile constatate si numarul stampilei C.T.C. de pe ambalaj. In cazul necomunicarii defectiunilor sau lipsurilor constatate in termenul de mai sus, SC LUX-ARTIM SRL nu-si asuma raspunderea pentru eventualele neconformitati. Va multumim pentru intelegere.

DOMINO - D2

CORP BAZA 2USI 80x82x53
VERSIUNEA: 01/1.10.2020



X2



30 min



A - Eurosurub 5x50 – 8 buc



G - Balama aplicata – 4 buc



B – Capacele adezive - 4 buc



H – Surub maner – 4 buc



C – Picior plastic reglabil – 4 buc



I – Cuie HDF - 22 buc

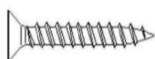

D – Holtzsurub 4x16 – 32 buc



J – Cheie imbus 5x50 - 1 buc



E - Maner - 2 buc



F - Suport polita - 4 buc

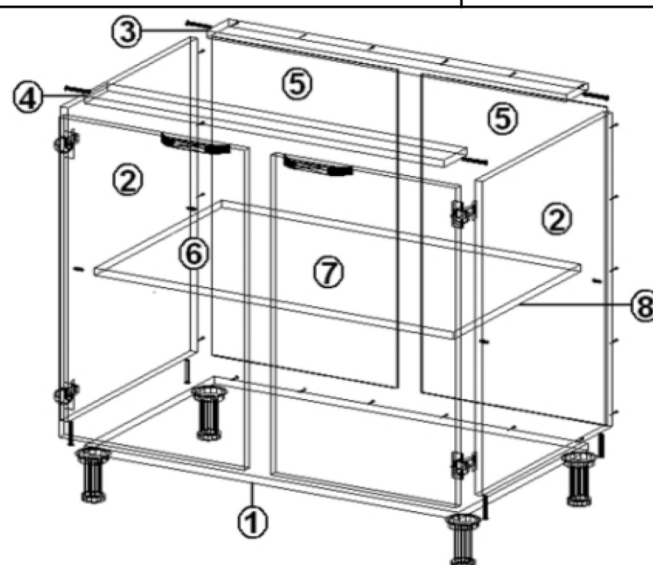

- 1 - Placa de baza PAL - 1 buc
- 2 - Laterala PAL - 2 buc
- 3 - Lonjeron spate PAL - 1 buc
- 4 - Lonjeron frontal PAL - 1 buc
- 5 - Spate HDF - 2 buc
- 6 - Usa stanga - 1 buc
- 7 - Usa dreapta - 1 buc
- 8 - Raft - 1 buc

Instructiuni de asamblare corp baza 2 usi

1. Se fixeaza cele 4 buc picioare **C** pe placa de baza **1** cu ajutorul holtzsuruburilor **D** la 4 cm de margine
2. Se cupleaza placa de baza **1** cu lateralele **2** folosind 4 buc eurosuruburi **A**
3. Se monteaza lonjeroanele **3** si **4** intre lateralele **2** cu eurosuruburi **A**
4. Se prind cu tinte **I** placile spate hdf **7** de placa fund **1**, lateralele **2** si lonjeronul spate **3**, verificand ca diagonalele carcasi sa fie egale
5. Se aseaza raftul **8** pe suportii polita **F** dupa introducerea lor in gaurile corespunzatoare din lateralele **2**
6. Se monteaza balamalele **G** pe usile **6** si **7** si pe lateralele **2** cu ajutorul holtzsuruburilor **D**
7. Se monteaza manerele **E** pe usile **6** si **7** cu ajutorul suruburilor **H** prin strapungerea gaurilor de maner din interior spre exterior
8. Pentru mascarea eurosuruburilor vizibile **A** se folosesc capacele albe autoadezive **B**.



Interior pentru
o stare de bine

SC LUX-ARTIM SRL
STR. AVANTULUI NR.11, ONESTI, BACAU
TEL.:0234317940, office@luxartim.ro
www.luxartim.ro

Va rugam sa verificati continutul coletului, existenta accesoriilor de feronerie, precum si a pieselor mentionate in schita de montaj. In cazul constatarii lipsurilor (feronerie, piese) sau defectiunilor va rugam sa anuntati personalul LUX ARTIM in termen de 24 ore de la achizitionarea produsului, comunicand lipsurile si defectiunile constatate si numarul stampilei C.T.C. de pe ambalaj. In cazul necomunicarii defectiunilor sau lipsurilor constatate in termenul de mai sus, SC LUX-ARTIM SRL nu-si asuma raspunderea pentru eventualele neconformitati. Va multumim pentru intelegere.

DOMINO - D4

CORP CUPTOR 82X60X53
VERSIUNEA:01/30.09.2020

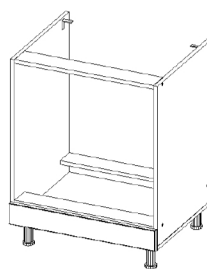

X2



20 min



A - Eurosurub 5x50 – 10 buc



E – Coltar Zn 22X22 -3buc



B –Capacele adezive–6 buc



F - Coltar Zn 40X40 - 2buc

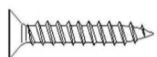

C - Holtzsurub 4x16 – 30 buc



G – Cheita imbus – 1 buc



D - Picioar plastic reglabil - 4 buc

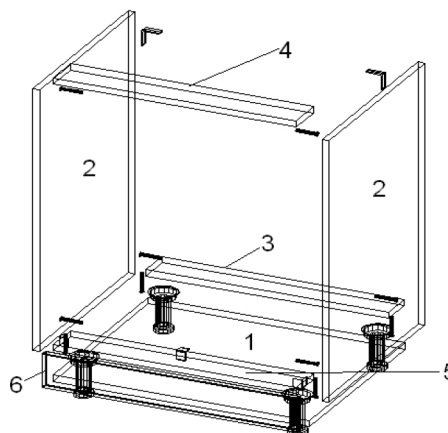

- 1 - Placa de baza PAL - 1 buc
- 2 - Laterala PAL - 2 buc
- 3 - Lonjeron spate PAL (necantuit) - 1 buc
- 4 - Lonjeron superior PAL - 1 buc
- 5 - Lonjeron frontal PAL - 1 buc
- 6 - Parte fixa PAL - 1 buc

Instructiuni de asamblare corp cuptor 60 cm

1. Se fixeaza cele 4 buc picioare D pe placa de baza 1 cu ajutorul holtzsuruburilor C la 4 cm de margine
2. Se cupleaza placa de baza 1 cu lateralele 2 folosind 4 buc eurosuruburi A
3. Se monteaza lonjeroanele 3, 4 si 5 intre lateralele 2 cu eurosuruburi A
4. Se prinde partea fixa 6 de lateralele 2 si lonjeronul 5 cu ajutorul coltarelor mici E si holtzsuruburilor C
5. Pentru mascarea eurosuruburilor vizibile A se folosesc capacele albe autoadezive B.

* Optional: pentru fixarea blatului se vor folosi 2 coltare F prinse cu holtzsuruburi C