



Interior pentru  
o stare de bine

SC LUX-ARTIM SRL  
STR. AVANTULUI NR.11, ONESTI, BACAU  
TEL.:0234317940, office@luxartim.ro  
[www.luxartim.ro](http://www.luxartim.ro)

Va rugam sa verificati continutul coletului, existenta accesoriilor de feronerie, precum si a pieselor mentionate in schita de montaj. In cazul constatarii lipsurilor (feronerie, piese) sau defectiunilor va rugam sa anuntati personalul LUX ARTIM in termen de 24 ore de la achizitionarea produsului, comunicand lipsurile si defectiunile constatate si numarul stampilei C.T.C. de pe ambalaj. In cazul necomunicarii defectiunilor sau lipsurilor constatate in termenul de mai sus, SC LUX-ARTIM SRL nu-si asuma raspunderea pentru eventualele neconformitati. Va multumim pentru intelegere.

## DOMINO - D9

CORP SUSPENDAT 2USI STICLA 80x65x32  
VERSIUNEA: 01/1.10.2020















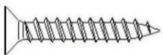

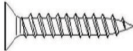
X2



30 min



 <b>A - Eurosurbub 5x50 – 12 buc</b>	 <b>H - Balama aplicata – 2 buc</b>
 <b>B – Capacele adezive -12 buc</b>	 <b>I – Surub maner – 4 buc</b>
 <b>C - Holtzsurbub 3.5x16 – 16 buc</b>	 <b>J - Balama semiaplicata - 2 buc</b>
 <b>D – Holtzsurbub 4x16 – 20 buc</b>	 <b>K -Cuie HDF – 24 buc</b>
 <b>E - Maner – 2 buc</b>	 <b>L – Cheita imbus – 1 buc</b>
 <b>F – Diblu 10x60 – 2 buc</b>	 <b>M - Coltar L demontabil – 2 buc</b>
 <b>G – Holtzsurbub 6x70 – 2 buc</b>	 <b>N - Telescop gaz - 4 buc</b>

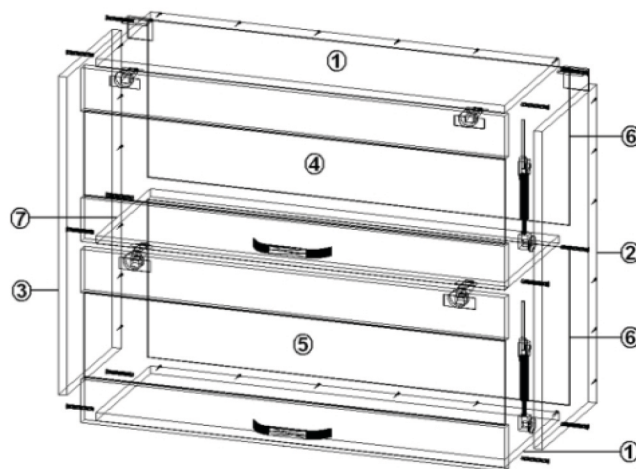

- 1 - Placa orizontala - 2 buc
- 2 - Laterala dreapta PAL - 1 buc
- 3 - Laterala stanga PAL - 1 buc
- 4 - Usa superioara - 1 buc
- 5 - Usa inferioara - 1 buc
- 6 - Spate HDF - 2 buc
- 7 - Raft PAL - 1 buc

### Instructiuni de asamblare corp suspendat 2 usi sticla

1. Se cupleaza lateralele **2** si **3** cu placile orizontale **1** folosind 8 buc eurosurbuburi **A**
2. Se fixeaza raftul **7** intre lateralele **2** si **3** cu 4 buc eurosurbuburi **A**
3. Se prind cu tinte **K** placile spate hdf **6** pe lateralele **2** si **3** si placile orizontale **1** prin batere cu ciocanul
4. Se monteaza balamalele **H** pe usa **4** cu holtzsurbuburi **C**, apoi se fixeaza pe placa orizontala superioara **1** cu holtzsurbuburi **D**
5. Se monteaza balamalele **J** pe usa **5** cu holtzsurbuburi **C**, apoi se fixeaza pe raftul **7** cu holtzsurbuburi **D**
6. Montarea tuburilor de gaz **N** se face intre usa **4** si lateralele dreapta **2** si stanga **3**, respectiv usa **5** si lateralele dreapta **2** si stanga **3** cu ajutorul holtzsurbuburilor **D**
7. Se prind manerele **E** pe usile **4** si **5** cu suruburile **I**, prin strapungerea gaurilor din interior spre exterior
8. Pentru fixarea corpului de perete sunt folosite 2 coltare L demontabile **M** prinse in partea superioara pe placa **1** cu holtzsurbuburi **D**, iar in perete cu dibluri **F** si holtzsurbuburi **G**
9. Pentru mascarea eurosurbuburilor vizibile **A** se folosesc capacele albe autoadezive **B**.

Va rugam sa verificati continutul coletului, existenta accesoriilor de feronerie, precum si a pieselor mentionate in schita de montaj. In cazul constatarii lipsurilor (feronerie, piese) sau defectiunilor va rugam sa anuntati personalul LUX ARTIM in termen de 24 ore de la achizitionarea produsului, comunicand lipsurile si defectiunile constatate si numarul stampilei C.T.C. de pe ambalaj. In cazul necomunicarii defectiunilor sau lipsurilor constatate in termenul de mai sus, SC LUX-ARTIM SRL nu-si asuma raspunderea pentru eventualele neconformitati. Va multumim pentru intelegere.

## DOMINO - D10

CORP HOTA 60x50x32.1  
VERSIUNEA: 1/01.10.2020

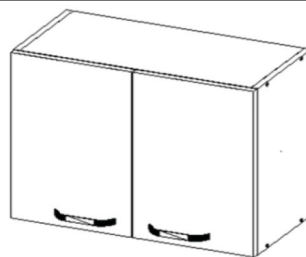

X2



30 min



A - Eurosurub 5x50 – 8 buc



H - Balama aplicata – 4 buc



B – Capacele adezive -8 buc



I – Surub maner – 4 buc



C - Holtzsurub 6x70 – 2 buc



J – Coltar L demontabil – 2 buc

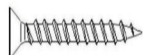

D – Holtzsurub 4x16 – 20 buc



K - Cuie HDF – 16 buc



E - Maner – 2 buc



L – Cheita inbus – 1 buc



F – Diblu 10x60 – 2 buc

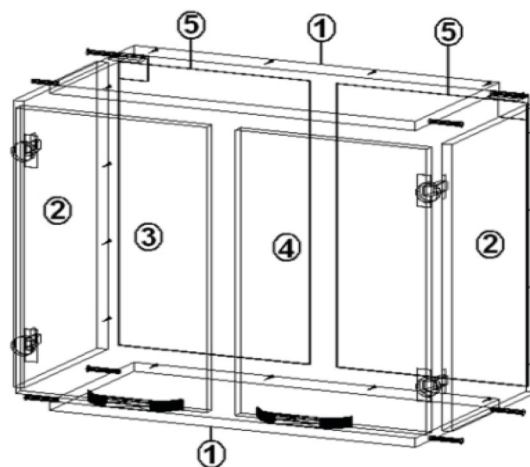

1 - Placa orizontala - 2 buc  
2 - Laterală PAL - 2 buc  
3 - Usa stanga - 1 buc  
4 - Usa dreapta - 1 buc  
5 - Spate HDF - 2 buc

### Instructiuni de asamblare corp hota

1. Se cupleaza lateralele 2 cu placile orizontale 1 folosind 8 buc eurosuruburi A
2. Se prind cu tinte K placile spate hdf 5 pe lateralele 2 si placile orizontale 1 prin batere cu ciocanul verificand ca diagonalele carcusei sa fie egale
3. Se monteaza balamalele H pe usile 3 si 4 cu holtzsuruburi D, apoi se fixeaza pe lateralele 2 cu holtzsuruburi D
4. Se prind manerele E pe usile 3 si 4 cu suruburile I
5. Pentru fixarea corpului de perete sunt folosite 2 coltare L demontabile J prinse in partea superioara pe placa 1 cu holtzsuruburi D, iar in perete cu dibluri F si holtzsuruburi C
6. Pentru mascarea eurosuruburilor vizibile A se folosesc capacele albe autoadezive B.



Va rugam sa verificati continutul coletului, existenta accesoriilor de feronerie, precum si a pieselor mentionate in schita de montaj. In cazul constatarii lipsurilor (feronerie, piese) sau defectiunilor va rugam sa anuntati personalul LUX ARTIM in termen de 24 ore de la achizitionarea produsului, comunicand lipsurile si defectiunile constatate si numarul stampilei C.T.C. de pe ambalaj. In cazul necomunicarii defectiunilor sau lipsurilor constatate in termenul de mai sus, SC LUX-ARTIM SRL nu-si asuma raspunderea pentru eventualele neconformitati. Va multumim pentru intelegere.

## DOMINO - D12

CORP BAZA 3SERTARE 60X82x53  
VERSIUNEA: 01/1.10.2020

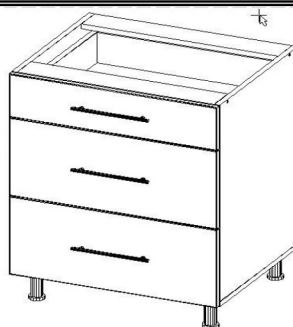



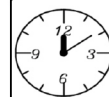







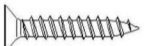

X2

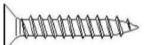

30 min



	
<b>A</b> - Eurosurub 5x50 - 8 buc	<b>I</b> - Maner - 3 buc
<b>B</b> - Eurosurub 7x50 - 3 buc	
	
<b>C</b> - Capacele adezive - 4 buc	<b>J</b> - Surub maner 4x25 - 6 buc
	
<b>D</b> - Holtzsurub 4x30 - 6 buc	<b>K1</b> - Set metalbox 500x86-1 set
	<b>K2</b> - Set metalbox 500x150-2 seturi
<b>E</b> - Holtzsurub 4x16 - 32 buc	
	<b>L</b> - Cheie imbus 5x50 - 1 buc
<b>F</b> - Holtzsurub 3,5x16 - 90 buc	<b>M</b> - Cheie imbus 7x50 - 1 buc
	
<b>G</b> - Holtzsurub 4x25 - 12 buc	<b>N</b> - Cuie HDF - 34 buc
	
<b>H</b> - Picior plastic reglabil - 4 buc	<b>O</b> - Amortizor si placuta amortizare - 3 buc

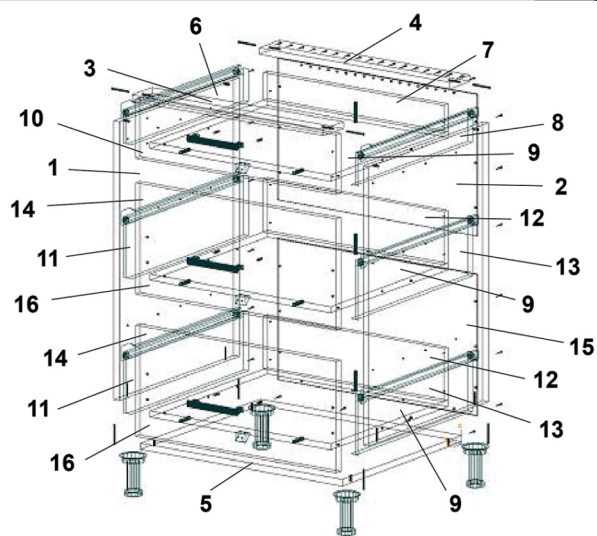

1 - Laterală stanga	9 - Baza sertar 3 buc
2 - Laterală dreapta	10 - Fata exterior sertar
3 - Lonjeron fata	11 - Laterală stanga metalbox sertar 2 buc
4 - Lonjeron spate	12 - Spate sertar 2 buc
5 - Placa de baza	13 - Laterală dreapta metalbox sertar 2 buc
6 - Laterală stanga metalbox sertar	14 - Fata exteriora sertar 2 buc
7 - Spate sertar	15 - Spate HDF 2 buc
8 - Laterală dreapta metalbox sertar	

### Instructiuni de asamblare corp baza 3 sertare

- 1 - Se monteaza picioarele de plastic H pe placa de baza 5 cu holtzsuruburile E.
- 2 - Se cupleaza placa de baza 5 cu lateralele 1 si 2 folosind eurosuruburi A.
- 3 - Se monteaza lonjeroanele 3 si 4 intre lateralele 1 si 2 cu eurosuruburi A.
- 4 - Se prind placile spate HDF 15 de lateralele 1 si 2, placa de baza 5 si lonjeron spate 4, folosind cuie HDF N.
- 5 - Se monteaza sinele de la seturile metalbox K pe lateralele 1 si 2 cu holtzsuruburi F.
- 6 - Se monteaza sertarul cupland lateralele metalbox 6 de fundul sertarului 8 cu holtzsuruburi F. Intre laterale se monteaza spate sertar 7 cu holtzsuruburi E. Placa fund 8 se prinde de spate sertar 7 cu eurosurub B.
- 7 - Pe laterala stanga se prinde amortizorul O, iar placuta amortizare se prinde pe fundul sertarului 8, in partea stanga, pe punctare, cu holtzsuruburi G.
- 8 - Fata sertarului 10 si 14 se monteaza pe sertar si se fixeaza manerul I cu suruburile J.
- 9 - Se aplica capacele autoadezive C pe toate eurosuruburile A vizibile.









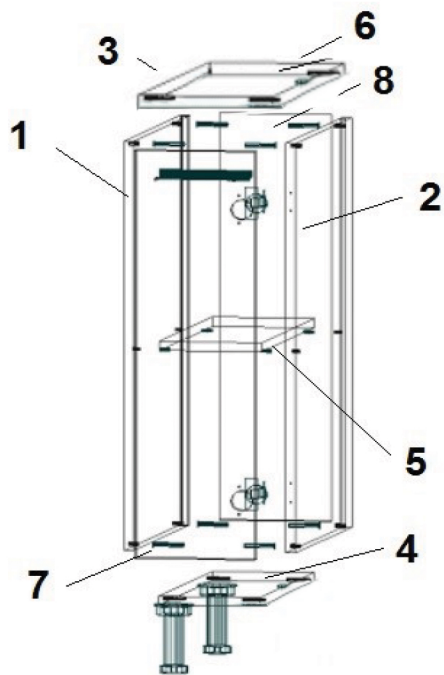

Va rugam sa verificati continutul coletului, existenta accesoriilor de feronerie, precum si a pieselor mentionate in schita de montaj. In cazul constatarii lipsurilor (feronerie, piese) sau defectiunilor va rugam sa anuntati personalul LUX ARTIM in termen de 24 ore de la achizitionarea produsului, comunicand lipsurile si defectiunile constatate si numarul stampilei C.T.C. de pe ambalaj. In cazul necomunicarii defectiunilor sau lipsurilor constatate in termenul de mai sus, SC LUX-ARTIM SRL nu-si asuma raspunderea pentru eventualele neconformitati. Va multumim pentru intelegere.

**DOMINO - D19**  
CORP BAZA 1USA 1RAFT 20x82x53



30min



 A-eurosurub 5x50 - 8buc	 D-holtzsurub 4x16 - 16buc	 G-maner - 1buc	 J-holtzsurub 4x25 - 4buc
 B-cuie HDF - 14buc	 E-picior plastic - 2buc	 H-balama - 2buc	 K-cheie imbus 5x50 - 1buc
 C-Capacele autoadezive - 4buc	 F- suport polita - 4buc	 I-surub maner - 2buc	

- |                         |                      |            |
|-------------------------|----------------------|------------|
| 1-Laterala stanga-1buc  | 4-Placa capac-1buc   | 7-HDF-1buc |
| 2-Laterala dreapta-1buc | 5-Polita mobila-1buc |            |
| 3-Placa baza-1buc       | 6-Usa-1buc           |            |

1. Se cupleaza placa baza 3 de lateralele 1 si 2 cu eurosuruburi A;
2. Se cupleaza placa capac 4 de lateralele 1 si 2 cu eurosuruburi A;
3. Se fixeaza placa spate HDF 7 de lateralele 1 si 2, placa de baza 3 si placa capac 4, folosind cuie HDF B;
4. Pe placa baza 3, la 4cm de marginea din fata respectiv din spate, se prind picioarele E cu holtzsuruburi D, pe linia lateralelor pentru a evita ruperea placii de baza;
5. Se bat cu ciocanul suportii de polita F in gaurile de pe lateralele 1 si 2, dupa care se aseaza polita 5;
6. Se monteaza balamalele H pe usa 6 cu holtzsuruburi D
7. Se monteaza placutele balamalelor H, cu holtzsuruburi D, pe laterala 1 sau 2 (dupa cum doriti deschiderea), dupa care se gaureste pentru maner cu un burghiu de 4,8 din interior spre exterior;
8. Se fixeaza manerul G pe usa 7 cu suruburile I;
9. Se aplica capacelele autoadezive pe toate eurosuruburile A vizibile.



Va rugam sa verificati continutul coletului, existenta accesoriilor de feronerie, precum si a pieselor mentionate in schita de montaj. In cazul constatarii lipsurilor (feronerie, piese) sau defectiunilor va rugam sa anuntati personalul LUX ARTIM in termen de 24 ore de la achizitionarea produsului, comunicand lipsurile si defectiunile constatate si numarul stampilei C.T.C. de pe ambalaj. In cazul necomunicarii defectiunilor sau lipsurilor constatate in termenul de mai sus, SC LUX-ARTIM SRL nu-si asuma raspunderea pentru eventualele neconformitati. Va multumim pentru intelegere.











## DOMINO - D20

CORP TURN 3USI 60X211X53

VERSIUNEA: 1/01.10.2020



30 min

	
<b>A - Eurosurub 5x50 – 16 buc</b>	<b>F - Balama aplicata – 6 buc</b>
	
<b>B – Capacele adezive -8 buc</b>	<b>G – Surub maner – 6 buc</b>
	
<b>C – Picioar plastic reglabil – 4 buc</b>	<b>H – Cuie Hdf -50 buc</b>
	
<b>D – Holtzsurub 4x16 – 40 buc</b>	<b>I – Cheita imbus 5x50 – 1 buc</b>
	
<b>E - Maner – 3 buc</b>	<b>J– Suport polita – 8 buc</b>

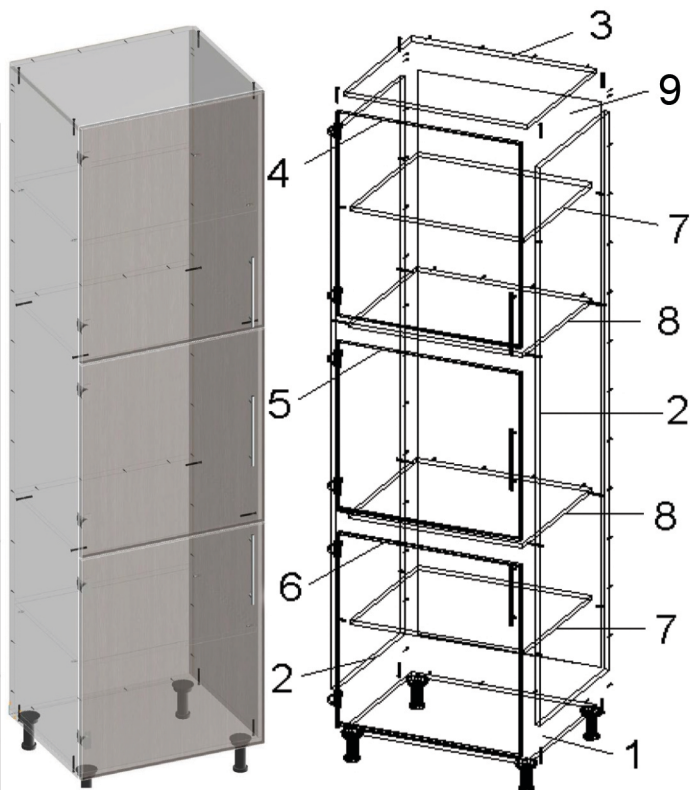

1-Placa de baza

2-Laterala 2 buc

3-Placa capac

4-Usa superioara 678mm

5-Usa mijoc 607mm

6-Usa inferioara 717mm

7-Polita mobila 2 buc

8-Polita fixa 2 buc

9-Placa spate HDF

### Instructiuni de asamblare:

- 1 - Se fixeaza cele 4 picioare C pe placa de baza 1 cu holtzsuruburi D la 4 cm de margine;
- 2 - Se cupleaza placa de baza 1 de lateralele 2 folosind 4 buc eurosuruburi A;
- 3 - Se monteaza capacul 3 pe lateralele 2 cu eurosuruburi A;
- 4 - Se monteaza politele fixe 8 intre lateralele 2 cu eurosuruburi A;
- 5 - Se prinde placa spate Hdf 9 de placa de baza 1, lateralele 2 si placa capac 3, folosind cuie Hdf H;
- 6 - Se monteaza balamalele F pe usa superioara 4, din mijloc 5 si inferioara 6, folosind holtzsuruburi D;
- 7 - Se prind usile pe laterala punctata cu holtzsuruburi D;
- 8 - Se introduc suportii de polita J in gaurile de fixare, apoi se aseaza rafturile 7;
- 9 - Se monteaza manerele E pe cele trei usi cu suruburile G;
- 10 - Pentru mascarea eurosuruburilor vizibile se folosesc capacele albe autoadezive B.

Va rugam sa verificati continutul coletului, existenta accesoriilor de feronerie, precum si a pieselor mentionate in schita de montaj. In cazul constatarii lipsurilor (feronerie, piese) sau defectiunilor va rugam sa anuntati personalul LUX ARTIM in termen de 24 ore de la achizitionarea produsului, comunicand lipsurile si defectiunile constatate si numarul stampilei C.T.C. de pe ambalaj. In cazul necomunicarii defectiunilor sau lipsurilor constatate in termenul de mai sus, SC LUX-ARTIM SRL nu-si asuma raspunderea pentru eventualele neconformitati. Va multumim pentru intelegere.





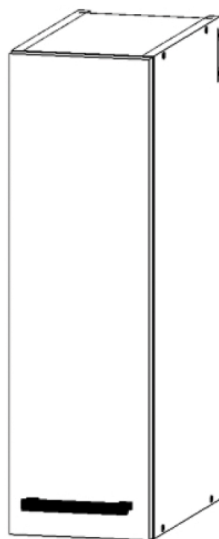



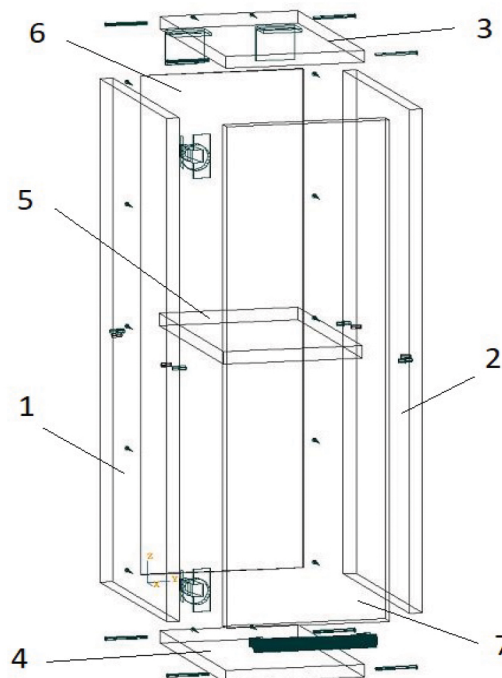

## DOMINO - D21

CORP SUSPENDAT 1USA 1RAFT 20X65X32.1

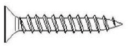

30min



 A-eurosurub 5x50 - 8buc	 D-cuie HDF - 14buc	 G- suport polita - 4buc	 J – Holtzsurub 6x70 – 2 buc
 B-capacele autoadezive-8buc	 E-holtzsurub 4x16 - 12buc	 H-Coltar L demontabil-2 buc	 K-balama -2buc
 C-cheie imbus 5x50- 1buc	 F - Maner – 1 buc	 I-Surub maner - 2buc	 L – Diblu 10x60 – 2 buc

1-Laterala stanga-1buc

4-Placa baza-1buc

7-Usa -1buc

2-Laterala dreapta-1buc

5-Raft-1buc

3-Capac interior - 1buc

6-Spate HDF - 1buc

1. Se cupleaza lateralele 1 si 2 cu capac 3 si placa baza 4 folosind eurosuruburi A;

2. Se prinde spatele HDF 6 cu tinte HDF D, prin batere cu ciocanul pe cadrul format de lateralele 1 si 2, capac 3 si placa baza 4

3. Se monteaza balamalele K pe usa 7 cu holtzsuruburi E, apoi se fixeaza pe laterala 2 cu holtzsuruburi E

4. Se prinde manerul F pe usa 7 cu suruburile I

5. Se aseaza raftul 5 pe suportii de polita G dupa introducerea lor in gaurile corespunzatoare din lateralele 1 si 2

6. Pentru fixarea corpului de perete sunt folosite 2 coltare "L" demontabile H prinse in partea superioara pe placa capac 3 cu holtzsuruburi E, iar in perete cu dibluri L si holtzsuruburi J

7. Pentru mascarea eurosuruburilor vizibile A se folosesc capacele albe autoadezive B.



Va rugam sa verificati continutul coletului, existenta accesoriilor de feronerie, precum si a pieselor mentionate in schita de montaj. In cazul constatarii lipsurilor (feronerie, piese) sau defectiunilor va rugam sa anuntati personalul LUX ARTIM in termen de 24 ore de la achizitionarea produsului, comunicand lipsurile si defectiunile constatate si numarul stampilei C.T.C. de pe ambalaj. In cazul necomunicarii defectiunilor sau lipsurilor constatate in termenul de mai sus, SC LUX-ARTIM SRL nu-si asuma raspunderea pentru eventualele neconformitati. Va multumim pentru intelegere.

**DOMINO - D1**  
MASCA CHIUVETA 2USI 80x82x53  
VERSIUNEA: 01/02.10.2010











X2



30 min

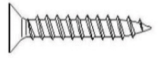

 <b>A - Eurosurub 5x50 – 8 buc</b>	 <b>G - Balama aplicata – 4 buc</b>
 <b>B-Capacele adezive – 4 buc</b>	 <b>H – Surub maner – 4 buc</b>
 <b>C-Picior plastic reglabil-4 buc</b>	 <b>I – Coltar Zn 40x40– 4 buc</b>
 <b>D-Holtzsurub 4x16 – 48 buc</b>	 <b>F – Cheita inbus 5x50 – 1 buc</b>
 <b>E –Maner – 2 buc</b>	

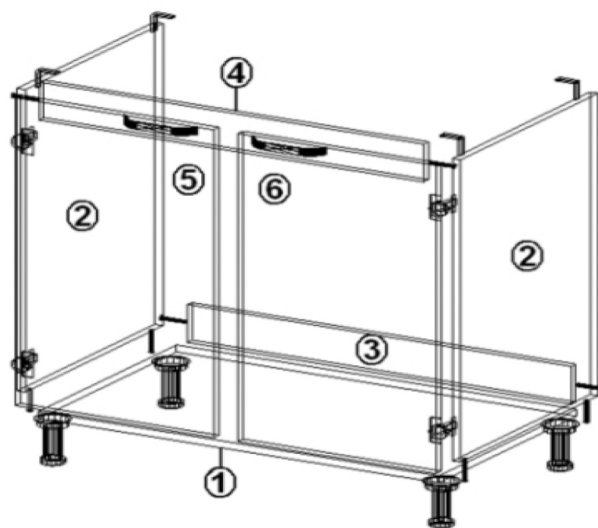

- 1 - Placa de baza PAL – 1 buc
- 2 - Laterala PAL – 2 buc
- 3 - Lonjeron spate PAL – 1 buc
- 4 - Lonjeron frontal PAL - 1 buc
- 5 - Usa stanga - 1 buc
- 6 - Usa dreapta - 1 buc

**Instructiuni de asamblare corp masca chiuveta 2 usi**

1. Se fixeaza cele 4 buc picioare C pe placa de baza 1 cu ajutorul holtzsuruburilor D la 4 cm de margine
2. Se cupleaza placa de baza 1 cu lateralele 2 folosind 4 buc eurosuruburi A
3. Se monteaza lonjeroanele 3 si 4 intre lateralele 2 cu eurosuruburi A
4. Se monteaza balamalele G pe usile 5 si 6 si pe lateralele 2 cu ajutorul holtzsuruburilor D
5. Se monteaza manerele E pe usile 5 si 6 cu ajutorul suruburilor H, prin strapungerea gaurilor de maner din interior spre exterior
6. Pentru mascarea eurosuruburilor vizibile A se folosesc capacele albe autoadezive B.

\* Optional: pentru fixarea blatului se vor folosi 4 coltare I prinse cu holtzsuruburi D

Va rugam sa verificati continutul coletului, existenta accesoriilor de feronerie, precum si a pieselor mentionate in schita de montaj. In cazul constatarii lipsurilor (feronerie, piese) sau defectiunilor va rugam sa anuntati personalul LUX ARTIM in termen de 24 ore de la achizitionarea produsului, comunicand lipsurile si defectiunile constatate si numarul stampilei C.T.C. de pe ambalaj. In cazul necomunicarii defectiunilor sau lipsurilor constatate in termenul de mai sus, SC LUX-ARTIM SRL nu-si asuma raspunderea pentru eventualele neconformitati. Va multumim pentru intelegere.

## DOMINO - D2

CORP BAZA 2USI 80x82x53  
VERSIUNEA: 01/1.10.2020



X2



30 min



**A** - Eurosurub 5x50 – 8 buc



**G** - Balama aplicata – 4 buc



**B** – Capacele adezive - 4 buc



**H** – Surub maner – 4 buc



**C** – Picior plastic reglabil – 4 buc



**I** – Cuie HDF - 22 buc

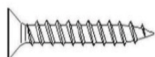

**D** – Holtzsurub 4x16 – 32 buc



**J** – Cheie imbus 5x50 - 1 buc



**E** - Maner - 2 buc



**F** - Suport polita - 4 buc

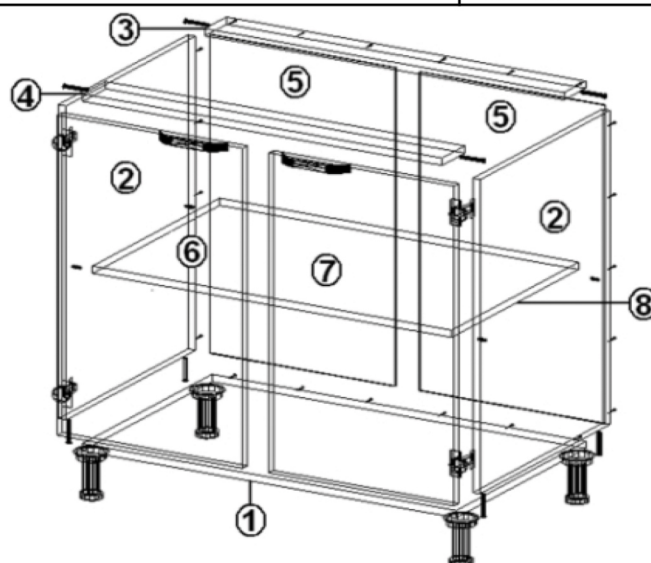

- 1 - Placa de baza PAL - 1 buc
- 2 - Laterala PAL - 2 buc
- 3 - Lonjeron spate PAL - 1 buc
- 4 - Lonjeron frontal PAL - 1 buc
- 5 - Spate HDF - 2 buc
- 6 - Usa stanga - 1 buc
- 7 - Usa dreapta - 1 buc
- 8 - Raft - 1 buc

### Instructiuni de asamblare corp baza 2 usi

1. Se fixeaza cele 4 buc picioare **C** pe placa de baza **1** cu ajutorul holtzsuruburilor **D** la 4 cm de margine
2. Se cupleaza placa de baza **1** cu lateralele **2** folosind 4 buc eurosuruburi **A**
3. Se monteaza lonjeroanele **3** si **4** intre lateralele **2** cu eurosuruburi **A**
4. Se prind cu tinte **I** placile spate hdf **7** de placa fund **1**, lateralele **2** si lonjeronul spate **3**, verificand ca diagonalele carcasi sa fie egale
5. Se aseaza raftul **8** pe suportii polita **F** dupa introducerea lor in gaurile corespunzatoare din lateralele **2**
6. Se monteaza balamalele **G** pe usile **6** si **7** si pe lateralele **2** cu ajutorul holtzsuruburilor **D**
7. Se monteaza manerele **E** pe usile **6** si **7** cu ajutorul suruburilor **H** prin strapungerea gaurilor de maner din interior spre exterior
8. Pentru mascarea eurosuruburilor vizibile **A** se folosesc capacele albe autoadezive **B**.



Va rugam sa verificati continutul coletului, existenta accesoriilor de feronerie, precum si a pieselor mentionate in schita de montaj. In cazul constatarii lipsurilor (feronerie, piese) sau defectiunilor va rugam sa anuntati personalul LUX ARTIM in termen de 24 ore de la achizitionarea produsului, comunicand lipsurile si defectiunile constatate si numarul stampilei C.T.C. de pe ambalaj. In cazul necomunicarii defectiunilor sau lipsurilor constatate in termenul de mai sus, SC LUX-ARTIM SRL nu-si asuma raspunderea pentru eventualele neconformitati. Va multumim pentru intelegere.

## DOMINO - D8

CORP SUSPENDAT 2USI 80x65x32.1  
VERSIUNEA: 1/1.10.2020

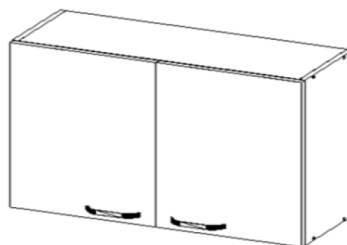

X2



30 min



**A** - Eurosurub 5x50 – 8 buc



**H** - Balama aplicata – 4 buc



**B** – Capacele adezive -8 buc



**I** – Surub maner – 4 buc



**C** - Holtzsurub 6x70– 2 buc



**J** - Suporti de polita – 4 buc

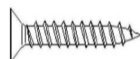

**D** – Holtzsurub 4x16 – 20 buc



**K** - Cuie HDF – 22 buc



**E** - Maner – 2 buc



**L** – Cheita imbus – 1 buc



**F** – Diblu 10x60 – 2 buc



**M** – Coltar L demontabil – 2 buc

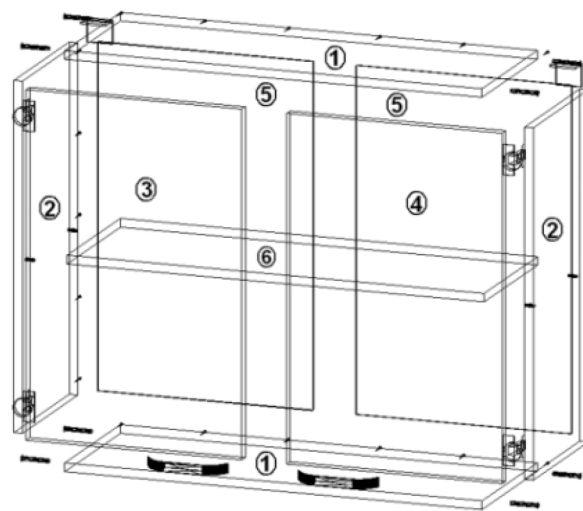

1 - Placa orizontala – 2 buc

2 - Laterala PAL – 2 buc

3 - Usa stanga – 1 buc

4 - Usa dreapta – 1 buc

5 - Spate hdf – 2 buc

6 - Raft - 1 buc

### Instructiuni de asamblare corp suspendat 2 usi

1. Se cupleaza lateralele 2 cu placile orizontale 1 folosind 8 buc eurosuruburi A
2. Se prind cu tinte K placile spate hdf 5 pe lateralele 2 si placile orizontale 1 prin batere cu ciocanul verificand ca diagonalele carcusei sa fie egale
3. Se monteaza balamalele H pe usile 3 si 4 cu holtzsuruburi D, apoi se fixeaza pe lateralele 2 cu holtzsuruburi D
4. Se prind manerele E pe usile 3 si 4 cu suruburile I
5. Se aseaza raftul 6 pe suportii de polita J dupa introducerea lor in gaurile corespunzatoare din lateralele 2
6. Pentru fixarea corpului de perete sunt folosite 2 coltare "L" demontabile M prinse in partea superioara pe placa 1 cu holtzsuruburi D, iar in perete cu dibluri F si holtzsuruburi C
7. Pentru mascarea eurosuruburilor vizibile A se folosesc capacele albe autoadezive B.