

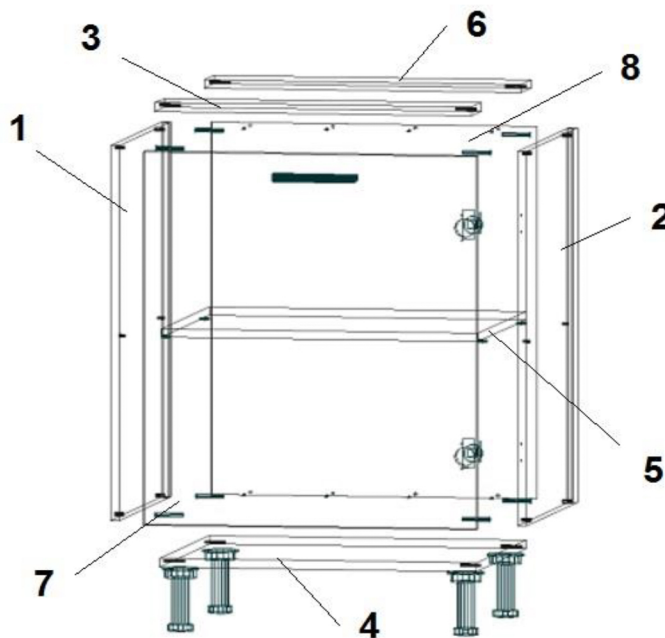

Va rugam sa verificati continutul coletului, existenta accesoriilor de feronerie, precum si a pieselor mentionate in schita de montaj. In cazul constatarii lipsurilor (feronerie, piese) sau defectiunilor va rugam sa anuntati personalul LUX ARTIM in termen de 24 ore de la achizitionarea produsului, comunicand lipsurile si defectiunile constatate si numarul stampilei C.T.C. de pe ambalaj. In cazul necomunicarii defectiunilor sau lipsurilor constatate in termenul de mai sus, SC LUX-ARTIM SRL nu-si asuma raspunderea pentru eventualele neconformitati. Va multumim pentru intelegere.

CHARM - C2S
CORP BAZA 1USA 1RAFT 60x84x54,3

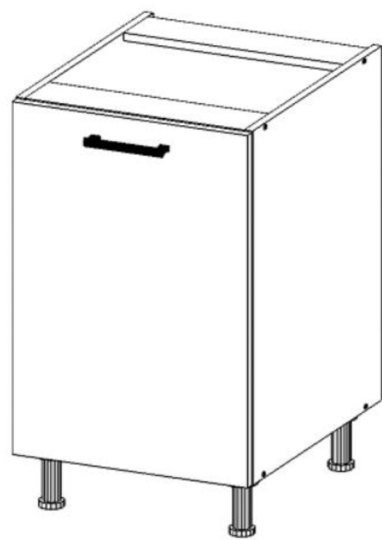

 A-eurosurub 7x50 - 8buc	 D-holtzsurub 4x16 - 4buc	 G- suport polita - 4buc	 J-Surub maner - 2buc
 B-cuie HDF - 8buc	 E-holtzsurub 4x25 - 4buc	 H-maner - 1buc	 K-cheie imbus 7x50 - 1buc
 C-holtzsurub 4x18 - 20buc	 F plastic - 4buc	 I-balama - 2buc	 L-capacele autoadezive-8buc

1- Laterala stanga-1buc	4-Placa baza-1buc	7-Usa-1buc
2-Laterala dreapta-1buc	5-Polita mobila-1buc	8-Placa spate HDF1buc
3-Lonjeron fata-1buc	6-Lonjeron spate-1buc	

1. Se cupleaza placa baza 4 de lateralele 1 si 2 cu eurosuruburi A;
2. Se aseaza placa spate HDF 8 in canalul de pe lateralele 1 si 2;
3. Se cupleaza lonjeroanele fata 3 si spate 6 de lateralele 1 si 2, folosind eurosuruburi A;
4. Se fixeaza placa spate HDF 8 de lonjeronul spate 6 si placa baza 7, folosind cuie HDF B;
5. Pe placa baza 4, la 4cm din fata respectiv din spate, se prind picioarele F cu holtzsuruburi C, pe linia lateralelor pentru a evita ruperea placii de baza;
6. Se bat cu ciocanul suportii de polita G in gaurile de pe lateralele 1 si 2, dupa care se aseaza polita 5;
7. Se monteaza balamalele I pe usa 7 cu holtzsuruburi C;
8. Se monteaza bratul balamalei H, cu holtzsuruburi D, pe laterala 1 sau 2 (dupa cum doriti deschiderea), dupa care se gaureste pentru maner cu un burghiu de 4,8 din interior spre exterior;
9. Se fixeaza manerul H pe usa 7 cu suruburile J;
10. Se aplica capacelele autoadezive pe toate eurosuruburile A vizibile;
11. Holtzsuruburile E pot fi folosite pentru cuplajul corpurilor intre ele.





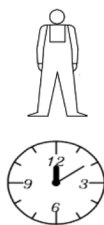
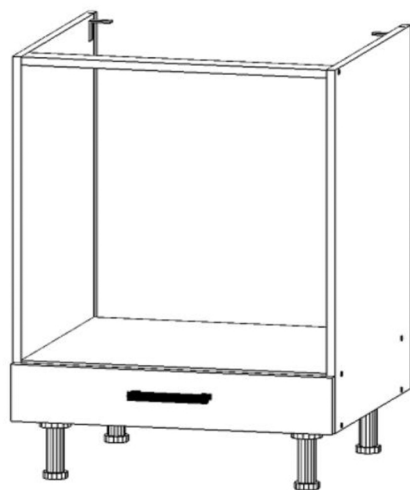



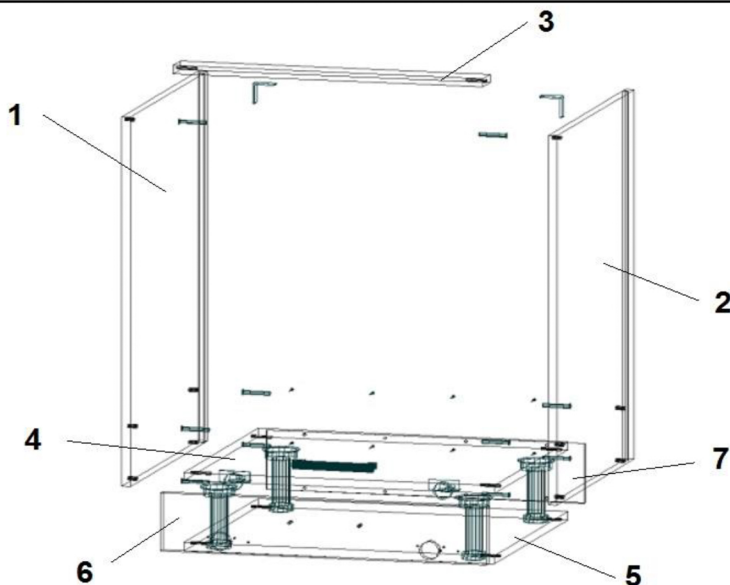

Va rugam sa verificati continutul coletului, existenta accesoriilor de feronerie, precum si a pieselor mentionate in schita de montaj. In cazul constatarii lipsurilor (feronerie, piese) sau defectiunilor va rugam sa anuntati personalul LUX ARTIM in termen de 24 ore de la achizitionarea produsului, comunicand lipsurile si defectiunile constatate si numarul stampilei C.T.C. de pe ambalaj. In cazul necomunicarii defectiunilor sau lipsurilor constatate in termenul de mai sus, SC LUX-ARTIM SRL nu-si asuma raspunderea pentru eventualele neconformitati. Va multumim pentru intelegere.

CHARM - C4S CORP CUPTOR 1USA 60x84x54,3



30min



 A-eurosurub 7x50 - 10buc	 D-picior plastic - 4buc	 G-holtzsurub 4x18 - 20buc H-holtzsurub 4x16 - 12buc I-holtzsurub 4x25 - 4buc	 K-Holtzsurub 3.5x16 - 2buc
 B-balama - 2buc	 E-maner banda - 1buc		 L-capacele autoadezive- 10buc
 C-cuie HDF-8buc	 F-coltar Zn 40x40 - 2buc	 J-cheie imbus 7x50 - 1buc	









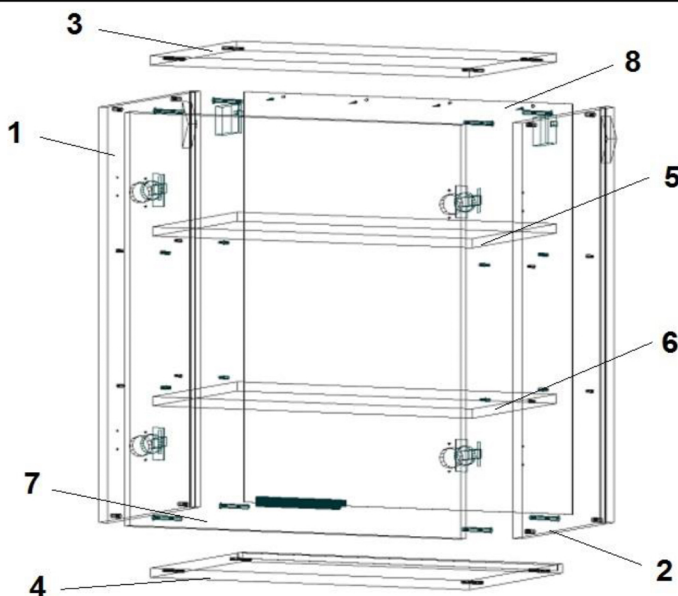
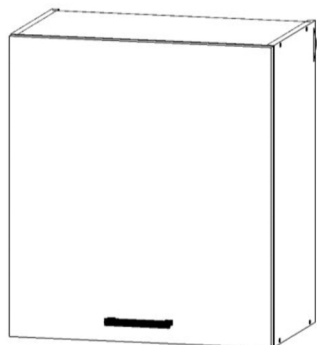

1- Laterala stanga-1buc	4-Polita fixa-1buc	7-HDF-1buc
2-Laterala dreapta-1buc	5-Placa baza-1buc	
3-Lonjeron fata-1buc	6-Usa-1buc	

- Se cupleaza placa baza 5 de lateralele stanga 1 si dreapta 2 cu eurosuruburi A;
- Se fixeaza lonjeron fata 3 de lateralele 1 si 2 cu eurosuruburi A;
- Se fixeaza HDF 7 in canalul lateralelor 1 si 2;
- Se monteaza balamalele B pe usa 6 folosind holtzsuruburi G;
- Se monteaza placutele balamalelor B pe placa baza 5, folosind holtzsuruburi H;
- Se fixeaza polita 4 de lateralele stanga 1 si dreapta 2 cu eurosuruburi A;
- Se fixeaza HDF 7 de placa baza 5 si polita fixa 4, folosind cuie HDF C;
- Se fixeaza picioarele D pe placa baza 5, cu holtzsuruburi G, la 4cm de marginea din fata, respectiv din spate, pe linia lateralelor, pentru a evita ruperea placii de baza;
- Se fixeaza manerul E pe cantul usii 6, cu holtzsuruburile maner K, pastrand 5cm de la margine;
- Se fixeaza coltarele Zn F in partea din spate a corpului cu holtzsuruburi H;
- Se aplica capacelele autoadezive pe toate eurosuruburile A vizibile.
- Pentru cuplarea corpurilor intre ele se folosesc holtzsuruburi I.

Va rugam sa verificati continutul coletului, existenta accesoriilor de feronerie, precum si a pieselor mentionate in schita de montaj. In cazul constatarii lipsurilor (feronerie, piese) sau defectiunilor va rugam sa anuntati personalul LUX ARTIM in termen de 24 ore de la achizitionarea produsului, comunicand lipsurile si defectiunile constatate si numarul stampilei C.T.C. de pe ambalaj. In cazul necomunicarii defectiunilor sau lipsurilor constatate in termenul de mai sus, SC LUX-ARTIM SRL nu-si asuma raspunderea pentru eventualele neconformitati. Va multumim pentru intelegere.

CHARM - C6S
CORP SUSPENDAT 1USA 2RAFTURI
60X72X37

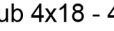

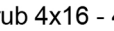
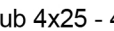
 A-eurosurub 7x50 - 8buc	 D-cuie HDF - 4buc	 I- suport polita - 8buc	 L-capacele autoadezive-8buc
 B- agatator reglabil stanga-1buc	 E-holtzsurub 4x30 - 4buc	 J-cheie imbus 7x50- 1buc	 M-balama -2buc
 C- agatator reglabil dreapta-1buc	 F-holtzsurub 4x18 - 4buc	 K-Surub maner - 2buc	 N-maner-1buc
 G-holtzsurub 4x16 - 4buc	 H-holtzsurub 4x25 - 4buc		

1- Laterală stanga-1buc
2-Laterală dreapta-1buc
3-Capac interior - 1buc

4-Placa baza-1buc
5-Polita mobila (raft)-1buc
6-Polita mobila (raft)-1buc









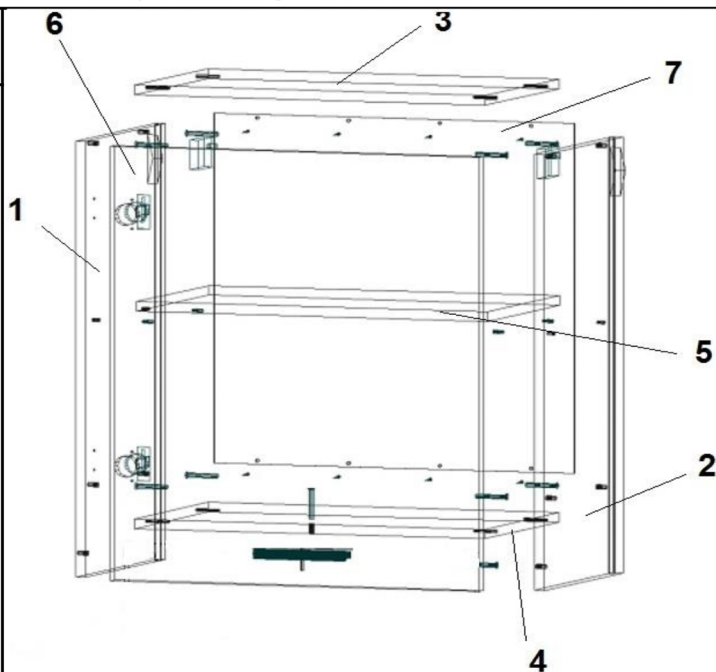
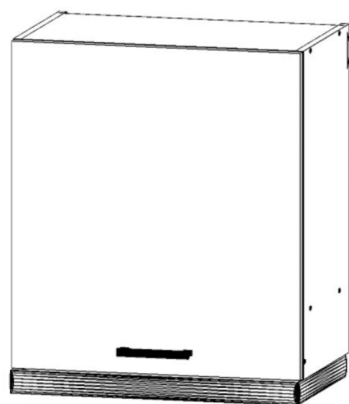

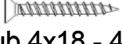
7-Usa -1buc
8- Spate HDF - 1buc

- Se cupleaza placa baza 4 de lateralele 1 si 2 cu eurosuruburi A;
- Se gaureste spatele HDF 8 astfel: se dau doua gauri cu freza $\Phi 25$, la 9mm de margine (stanga-dreapta) si 25mm de sus in jos;
- Se aseaza spatele HDF 8 in canalul lateralelor 1 si 2 si al placii baza 4, cu gaurile in partea de sus;
- Se cupleaza capacul interior 3 de lateralele 1 si 2 cu eurosuruburi A, dupa care se fixeaza de acesta placa spate HDF folosind cuie HDF D;
- Se fixeaza agatatorii reglabili B si C pe lateralele 1 si 2, in partea de sus a corpului, cu holtzsuruburi E;
- Se bat cu ciocanul suportii polita I in gaurile de pe lateralele 1 si 2, urmand a aseza politele 5 si 6;
- Se monteaza balamalele M pe usa 7 cu holtzsuruburi F;
- Se monteaza placutele balamalelor M cu holtzsuruburi G, pe laterala 1 sau 2(in functie de cum se doreste deschiderea usii) dupa care se strapung gaurile pentru maner cu un burghiu de 4,8 din interior spre exterior;
- Se fixeaza manerul N pe usa 7 cu suruburi K;
- Se aplica capacele L pe eurosuruburile A vizibile.
- Pentru cuplarea corpurilor intre ele se folosesc holtzsuruburile H.

Va rugam sa verificati continutul coletului, existenta accesoriilor de feronerie, precum si a pieselor mentionate in schita de montaj. In cazul constatarii lipsurilor (feronerie, piese) sau defectiunilor va rugam sa anuntati personalul LUX ARTIM in termen de 24 ore de la achizitionarea produsului, comunicand lipsurile si defectiunile constatate si numarul stampilei C.T.C. de pe ambalaj. In cazul necomunicarii defectiunilor sau lipsurilor constatate in termenul de mai sus, SC LUX-ARTIM SRL nu-si asuma raspunderea pentru eventualele neconformitati. Va multumim pentru intelegere.

CHARM - C10S
CORP SUSPENDAT HOTA 1USA 60X72X37



 A-eurosurub 7x50 - 8buc	 D-holtzsurub 4x18 - 4buc E-holtzsurub 4x16 - 4buc F-holtzsurub 4x25 - 4buc G-holtzsurub 4x30 - 4buc	 I-maner banda - 1buc	 L-holtzsurub 3.5x16- 2buc
 B-agatator reglabil stanga-1buc		 J-Cuie HDF-8buc	 M-cheie imbus 7x50- 1buc
 C-agatator reglabil dreapta-1buc	 H-balama - 2buc	 K-Suport polita-4buc	 N-capacele autoadezive-8buc
1- Laterala stanga-1buc 2-Laterala dreapta-1buc 3-Capac interior - 1buc	4-Polita fixa-1buc 5-Polita mobila (raft)-1buc 6-Usa-1buc	7-HDF-1buc	

1. Se cupleaza polita fixa 4 de lateralele 1 si 2 cu eurosuruburi A;
- 2.Placa HDF 7 se gaureste in partea de sus cu o freza de $\Phi 25$ la 25mm de sus in jos si la 9mm de la margine (stanga-dreapta), dupa care se introduc pe canal;
- 3.Se cupleaza capac interior 3 de lateralele 1 si 2 cu eurosuruburi A;
4. Pe laterala stanga 1 si dreapta 2 se fixeaza agatatorii reglabili B si C in partea de sus a corpului cu holtzsuruburi G;
- 5.Se fixeaza HDF 7 de capac interior 3 si polita fixa 4, folosind cuie HDF J;
6. Se gaureste polita fixa 4 in functie de tubulatura hotei, apoi se fixeaza hota;
- 7.Se bat cu ciocanul suportii de polita K pe laturile 1 si 2, dupa care se aseaza polita mobila 5;
8. Se monteaza balamalele H pe usa 6, folosind holtzsuruburi D;
- 9.Se monteaza placutele balamalelor pe laterala stanga 1, cu holtzsuruburi E;
10. Se fixeaza manerul I pe cantul usii 6 (pe latura de jos) folosind holtzsuruburile de maner L;
- 11.Se aplica capacele N pe toate eurosuruburile A vizibile.
- 12.Pentru cuplarea corpurilor intre ele se folosesc holtzsuruburi F.



Interior pentru
o stare de bine

SC LUX-ARTIM SRL
STR.AVANTULUI NR.11,ONESTI,BACAU
TEL.:0234317940, office@luxartim.ro
www.luxartim.ro

Va rugam sa verificati continutul coletului, existenta accesoriilor de feronerie, precum si a pieselor mentionate in schita de montaj. In cazul constatarii lipsurilor (feronerie, piese) sau defectiunilor va rugam sa anuntati personalul LUX ARTIM in termen de 24 ore de la achizitionarea produsului, comunicand lipsurile si defectiunile constatate si numarul stampilei C.T.C. de pe ambalaj. In cazul necomunicarii defectiunilor sau lipsurilor constatate in termenul de mai sus, SC LUX-ARTIM SRL nu-si asuma raspunderea pentru eventualele neconformitati. Va multumim pentru intelegere.

CHARM - C18S CORP TURN 2 USI 3 SERTARE 60X57X215.6

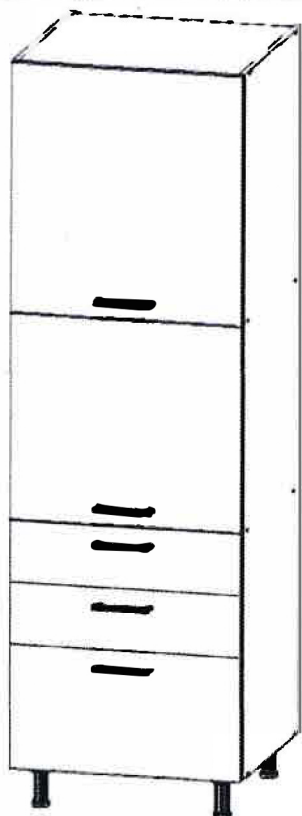

120min



- 1-Laterala stanga
- 2-Laterala dreapta
- 3-Capac interior
- 4-Polita fixa
- 5-Polita fixa
- 6-Placa de baza
- 7-Polita mobila
- 8-HDF
- 9-HDF
- 10-HDF
- 11-Usa
- 12-Usa
- 13-Laterala sertar stanga
- 14-Laterala sertar dreapta
- 15-Spate sertar
- 16-Fata interior sertar
- 17-Fata exterior sertar
- 18-Baza sertar
- 19-Laterala stanga sertar
- 20-Laterala dreapta sertar
- 21-Spate sertar
- 22-Fata interior sertar
- 23-Fata exterior sertar

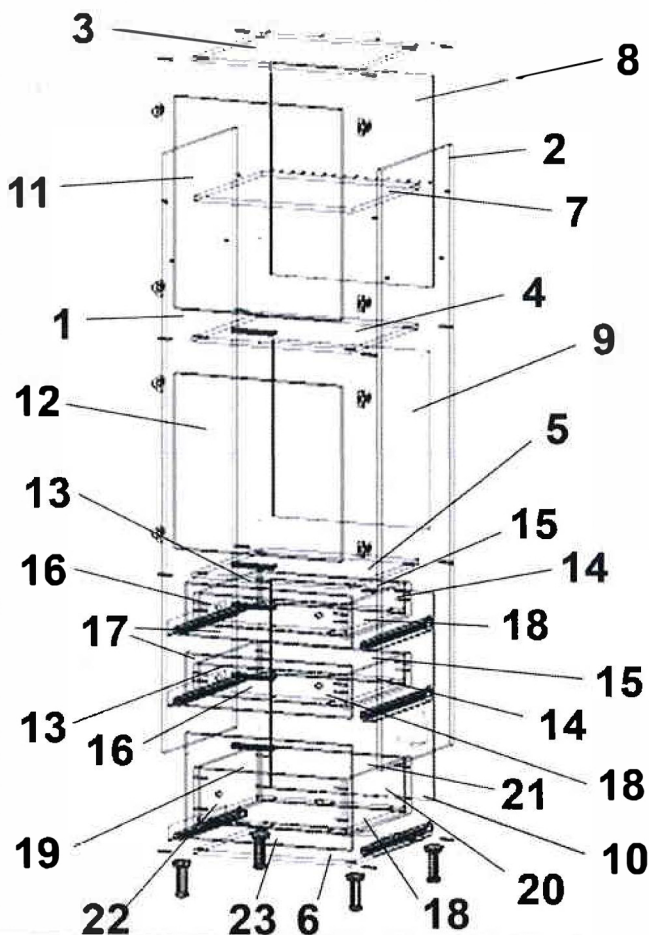

A-eurosurub 7x50 -16buc
B-eurosurub 5x50 -42buc

G-set tandem500-3seturi

K-maner - 5buc

N-capacele autoadezive-16 buc

C-holtzsurub 4x18 -88buc
D-holtzsurub 4x16 -12buc

H-picior plastic 120 - 4buc

L-element reglare front-6buc

O-suport polita - 4buc

E-holtzsurub 4x25 - 8buc

I -cuie HDF -20buc

M-Surub maner-10buc

P- surub element reglare front 4x25-6buc

F-balama - 4buc



J-cheie imbus 7x50 - 1buc



J-cheie imbus 7x50 - 1buc



- 1.Se cupleaza placa de baza 6 de lateralele 1 si 2 cu eurosuruburi A;
- 2.Se fixeaza politele fixe 4 si 5 de lateralele 1 si 2, folosind eurosuruburi A;
- 3.Se fixeaza placa capac 3 de lateralele 1 si 2 folosind eurosuruburi A;
- 4.Pe placa de baza 6, la 4 cm de la marginea din fata, respective spate, se monteaza picioarele H, folosind holtzsuruburi C, pe linia lateralelor pentru a evita ruperea placii de baza;
- 5.Se introduc in canalul de pe lateralele 1 si 2 cele 3 bucati HDF, cea de sus 8, cea din mijloc 9 si cea de jos 10;
- 6.Placile HDF 8, 9 si 10 se fixeaza folosind cuie HDF I de capac 3, placa de baza 6 si politele fixe 4 si 5;
- 7.Se fixeaza in gaurile de pe lateralele 1 si 2 suportii de polita O, dupa care se aseaza polita mobile 7;





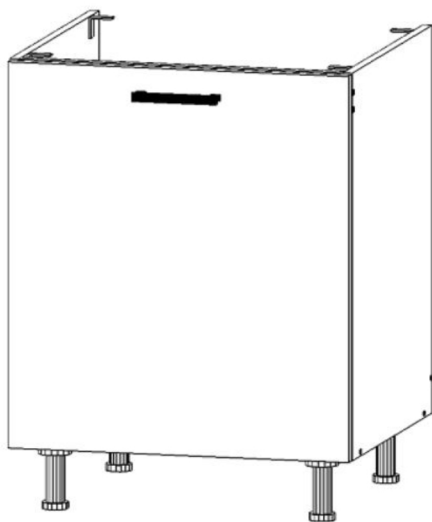



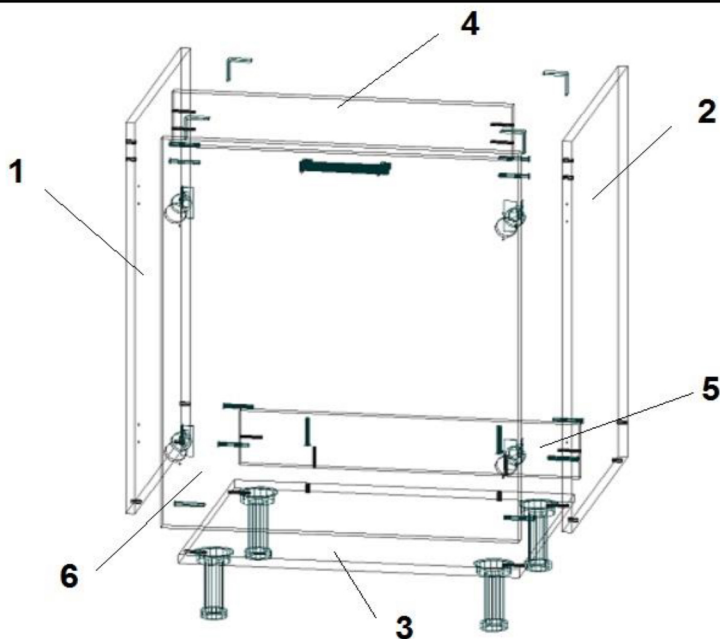

Va rugam sa verificati continutul coletului, existenta accesoriilor de feronerie, precum si a pieselor mentionate in schita de montaj. In cazul constatarii lipsurilor (feronerie, piese) sau defectiunilor va rugam sa anuntati personalul LUX ARTIM in termen de 24 ore de la achizitionarea produsului, comunicand lipsurile si defectiunile constatate si numarul stampilei C.T.C. de pe ambalaj. In cazul necomunicarii defectiunilor sau lipsurilor constatate in termenul de mai sus, SC LUX-ARTIM SRL nu-si asuma raspunderea pentru eventualele neconformitati. Va multumim pentru intelegere.

CHARM - C1S
MASCA CHIUVETA 1USA 60x84x54.3

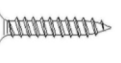
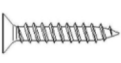

30min



 A-eurosurub 7x50 - 12buc	 D-picior plastic 120 - 4buc	 G-holtzsurub 4x16 - 20buc	 J-capacele autoadezive-10buc
 B-maner banda - 1buc	 E-coltar Zn 40x40-4buc	 H-holtzsurub 4x25 - 4buc	 K-Holtzsurub 3.5x16 - 2buc
 C-balama - 2buc	 F-holtzsurub 4x18 - 20buc	 I-cheie imbus 7x50-1buc	

1-Laterala stanga-1buc	4-Lonjeron fata sus-1buc
2-Laterala dreapta-1buc	5-Lonjeron spate jos-1buc
3-Placa baza-1buc	6-Usa -1buc

1. Se cupleaza placa baza 3 de lateralele 1 si 2 cu eurosuruburi A;
 2. Se fixeaza lonjeroanele fata sus 4 si spate jos 5 de lateralele 1 si 2 cu eurosuruburi A;
 3. Se fixeaza picioarele D pe placa baza 3 cu holtzsuruburi F, la distanta de 4cm de marginea din fata respectiv spate, pe linia lateralelor, pentru a evita ruperea placii de baza;
 4. Se monteaza balamalele C pe usa 6 cu holtzsuruburi F;
 5. Se monteaza bratul balamalei F folosind holtzsuruburi G, pe laterala 1 sau 2 (dupa cum se doreste deschiderea usii), dupa care se strapung gaurile pentru maner cu un burghiu de 4,8 din interior spre exterior;
 6. Se fixeaza manerul B pe cantul usii 6, cu holtzsuruburi de maner K, pastrand 5cm de la margine;
 7. Se aplica capacele autoadezive J pe eurosuruburile A vizibile;
 8. Se fiseaza coltarele Zn E pe lateralele 1 si 2 cu holtzsuruburi G;
 9. Holtzsuruburile H pot fi folosite pentru cuplarea corpurilor intre ele;
- Dupa montare, recomandam aplicarea unui cordon de silicon intre laterale si placa baza.





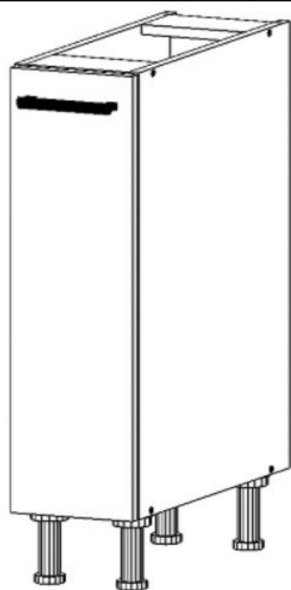



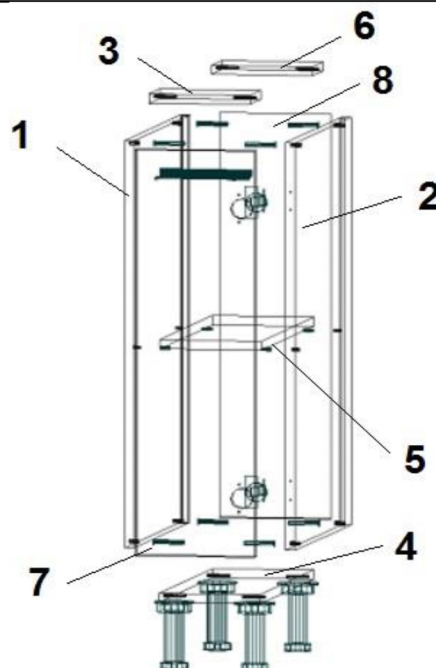



Va rugam sa verificati continutul coletului, existenta accesoriilor de feronerie, precum si a pieselor mentionate in schita de montaj. In cazul constatarii lipsurilor (feronerie, piese) sau defectiunilor va rugam sa anuntati personalul LUX ARTIM in termen de 24 ore de la achizitionarea produsului, comunicand lipsurile si defectiunile constatate si numarul stampilei C.T.C. de pe ambalaj. In cazul necomunicarii defectiunilor sau lipsurilor constatate in termenul de mai sus, SC LUX-ARTIM SRL nu-si asuma raspunderea pentru eventualele neconformitati. Va multumim pentru intelegere.

CHARM - C2D
CORP BAZA 1USA 1RAFT 20x84x54,3

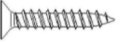

30min



 A-eurosurub 7x50 - 8buc	 D-holtzsurub 4x16 - 4buc	 G-maner - 1buc	 J-holtzsurub 4x25 - 4buc
 B-cuie HDF - 4buc	 E-picioar plastic - 4buc	 H-balama - 2buc	 K-cheie imbus 7x50 - 1buc
 C-holtzsurub 4x18-20buc	 F- suport polita - 4buc	 I-surub maner - 2buc	 L-capacele autoadezive-8buc
1- Laterala stanga-1buc 2-Laterala dreapta-1buc 3-Lonjeron fata-1buc	4-Placa baza-1buc 5-Polita mobila-1buc 6-Lonjeron spate-1buc	7-Usa-1buc 8-Spate HDF-1buc	

1. Se cupleaza placa baza 4 de lateralele 1 si 2 cu eurosuruburi A;
2. Se aseaza placa spate HDF 8 in canalul de pe lateralele 1 si 2;
3. Se cupleaza lonjeroanele fata 3 si spate 6 de lateralele 1 si 2, folosind eurosuruburi A;
4. Se fixeaza placa spate HDF 8 de lonjeronul spate 6 si placa baza 4, folosind cuie HDF, B;
5. Pe placa baza 4, la 4cm de marginea din fata respectiv din spate, se prind picioarele E cu holtzsuruburi C, pe linia lateralelor pentru a evita ruperea placii de baza;
6. Se bat cu ciocanul suportii de polita F in gaurile de pe lateralele 1 si 2, dupa care se aseaza polita 5;
7. Se monteaza balamalele H pe usa 7 cu holtzsuruburi C
8. Se monteaza placutele balamalelor H, cu holtzsuruburi D, pe laterala 1 sau 2 (dupa cum doriti deschiderea), dupa care se gaureste pentru maner cu un burghiu de 4,8 din interior spre exterior;
9. Se fixeaza manerul G pe usa 7 cu suruburile I;
10. Se aplica capacele autoadezive pe toate eurosuruburile A vizibile.