

Va rugam sa verificati continutul coletului, existenta accesoriilor de feronerie, precum si a pieselor mentionate in schita de montaj. In cazul constatarii lipsurilor (feronerie, piese) sau defectiunilor va rugam sa anuntati personalul LUX ARTIM in termen de 24 ore de la achizitionarea produsului, comunicand lipsurile si defectiunile constatate si numarul stampilei C.T.C. de pe ambalaj. In cazul necomunicarii defectiunilor sau lipsurilor constatate in termenul de mai sus, SC LUX-ARTIM SRL nu-si asuma raspunderea pentru eventualele neconformitati. Va multumim pentru intelegere.

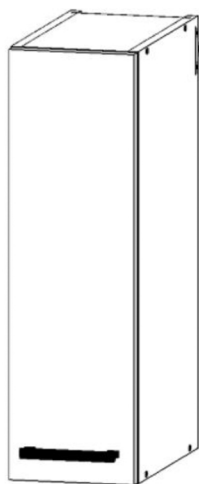







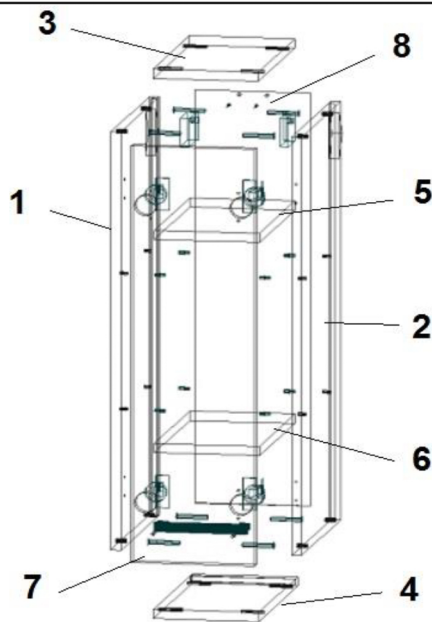

### CHARM - C6D

CORP SUSPENDAT 1USA 2RAFTURI 20X72X37



30min



 A-eurosurub 7x50 - 8buc	 D-cuie HDF - 2buc	 I- suport polita - 8buc	 L-capacele autoadezive-8buc
 B- agatator reglabil stanga-1buc	 E-holtzsurub 4x30 - 4buc	 J-cheie imbus 7x50- 1buc	 M-balama -2buc
 C- agatator reglabil dreapta-1buc	F-holtzsurub 4x18 - 4buc G-holtzsurub 4x16 - 4buc H-holtzsurub 4x25 - 4buc	 K-Surub maner - 2buc	 N-maner-1buc

1- Laterala stanga-1buc  
2-Laterala dreapta-1buc  
3-Capac interior - 1buc

4-Placa baza-1buc  
5-Polita mobila (raft)-1buc  
6-Polita mobila (raft)-1buc









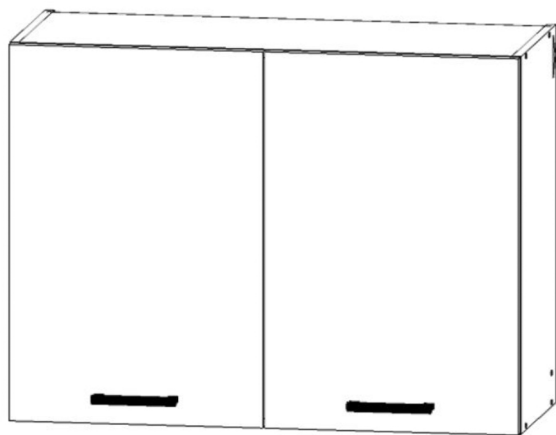
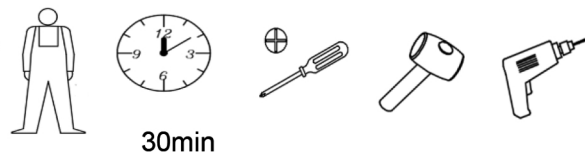
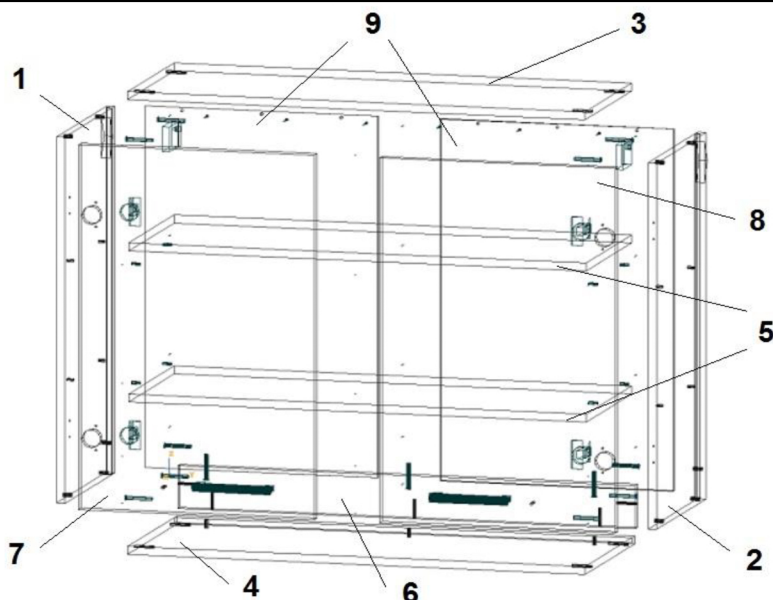



7-Usa -1buc  
8- Spate HDF - 1buc

1. Se cupleaza placa baza 4 de lateralele 1 si 2 cu eurosuruburi A;
2. Se gaureste spatele HDF 8 astfel: se dau doua gauri cu freza  $\Phi 25$ , la 9mm de margine (stanga-dreapta) si 25mm de sus in jos;
3. Se aseaza spatele HDF 8 in canalul lateralelor 1 si 2 si al placii baza 4, cu gaurile in partea de sus;
4. Se cupleaza capacul interior 3 de lateralele 1 si 2 cu eurosuruburi A, dupa care se fixeaza de acesta placa spate HDF folosind cuie HDF D;
5. Se fixeaza agatatorii reglabili B si C pe lateralele 1 si 2, in partea de sus a corpului, cu holtzsuruburi E;
6. Se bat cu ciocanul suportii polita I in gaurile de pe lateralele 1 si 2, urmand a aseza politele 5 si 6;
7. Se monteaza balamalele M pe usa 7 cu holtzsuruburi F;
8. Se monteaza placuta balamalelor M cu holtzsuruburi G, pe laterala 1 sau 2 (in functie de cum se doreste deschiderea usii) dupa care se strapung gaurile pentru maner cu un burghiu de 4,8 din interior spre exterior;
9. Se fixeaza manerul N pe usa 7 cu suruburi K;
10. Se aplica capacele L pe eurosuruburile A vizibile.
11. Pentru cuplarea corpurilor intre ele se folosesc holtzsuruburile H.

Va rugam sa verificati continutul coletului, existenta accesoriilor de feronerie, precum si a pieselor mentionate in schita de montaj. In cazul constatarii lipsurilor (feronerie, piese) sau defectiunilor va rugam sa anuntati personalul LUX ARTIM in termen de 24 ore de la achizitionarea produsului, comunicand lipsurile si defectiunile constatate si numarul stampilei C.T.C. de pe ambalaj. In cazul necomunicarii defectiunilor sau lipsurilor constatate in termenul de mai sus, SC LUX-ARTIM SRL nu-si asuma raspunderea pentru eventualele neconformitati. Va multumim pentru intelegere.

### CHARM - C6N CORP SUSPENDAT 2USI 2RAFTURI 90X72X37



 A-eurosurub 7x50 - 13buc	 D-cuie HDF - 6buc	 I- suport polita - 8buc	 L-capacele autoadezive-13buc
 B-agnetor reglabil stanga-1buc	 E-holtzsurub 4x30 - 4buc F-holtzsurub 4x18 - 8buc G-holtzsurub 4x16 - 8buc	 J-cheie imbus 7x50- 1buc	 M-profil imbinare HDF-1buc
 C-agnetor reglabil dreapta-1buc	 H-maner - 2buc O-holtzsurub 4x25 - 4buc	 K-Surub maner - 4buc	 N-balama - 4buc

1- Laterala stanga-1buc  
2-Laterala dreapta-1buc  
3-Capac interior - 1buc

4-Placa baza-1buc  
5-Polita mobila (raft)-2buc  
6-Plinta-1buc









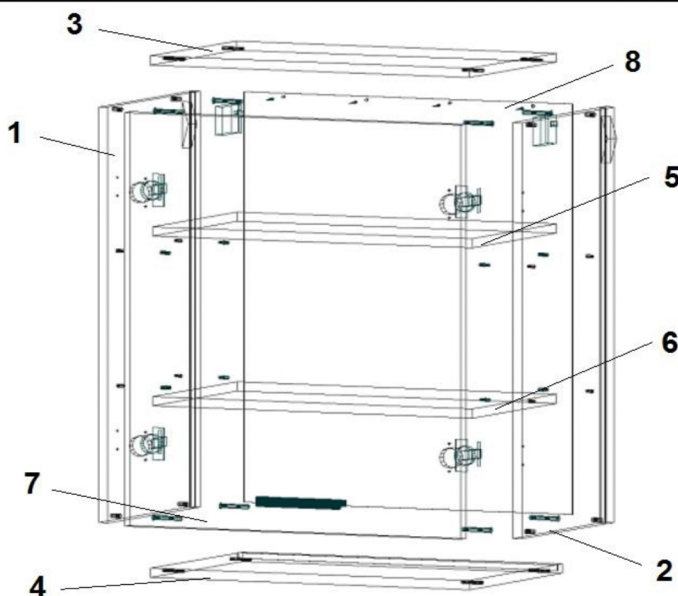
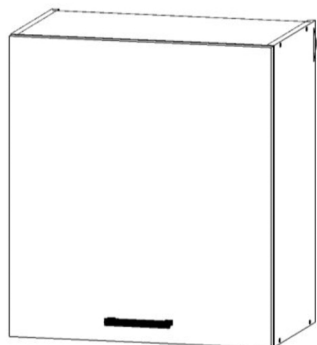

7-Usa stanga-1buc  
8-Usa dreapta - 1buc  
9-Placa spate HDF-2buc

- Se cupleaza placa baza 4 de lateralele 1 si 2 cu eurosuruburi A;
- Se imbina intre ele cele 2 placi spate HDF 9, folosind profil imbinare HDF M, se gauresc cu o freza  $\Phi 25$  in colturile exterioare, la 25mm de sus in jos si la 9mm de la margine, se introduc placile in canalul lateralelor 1 si 2 si al placii baza 4;
- Se cupleaza capacul interior 3 de lateralele 1 si 2 cu eurosuruburi A, dupa care se fixeaza de acesta placile spate HDF folosind cuie HDF D;
- Se fixeaza plinta 6 de lateralele 1 si 2 si placa baza 4 cu eurosuruburi A;
- Se fixeaza agatatorii reglabili B si C pe lateralele 1 si 2, in partea de sus a corpului, cu holtzsuruburi E;
- Se fixeaza suportii polita I pe lateralele 1 si 2, urmand a aseza politele 5;
- Se monteaza balamalele N pe usile 7 si 8, cu holtzsuruburi F;
- Se monteaza placutele balamalelor N pe lateralele 1 si 2 cu holtzsuruburi G;
- Se fixeaza manerele H pe usile 7 si 8 cu suruburi K
- Se aplica capacele L pe eurosuruburile A vizibile.
- Pentru prinderea corpurilor intre ele (stanga-dreapta) se pot folosi holtzsuruburile O.

Va rugam sa verificati continutul coletului, existenta accesoriilor de feronerie, precum si a pieselor mentionate in schita de montaj. In cazul constatarii lipsurilor (feronerie, piese) sau defectiunilor va rugam sa anuntati personalul LUX ARTIM in termen de 24 ore de la achizitionarea produsului, comunicand lipsurile si defectiunile constatate si numarul stampilei C.T.C. de pe ambalaj. In cazul necomunicarii defectiunilor sau lipsurilor constatate in termenul de mai sus, SC LUX-ARTIM SRL nu-si asuma raspunderea pentru eventualele neconformitati. Va multumim pentru intelegere.

**CHARM - C6S**  
**CORP SUSPENDAT 1USA 2RAFTURI**  
**60X72X37**

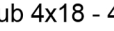

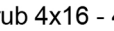
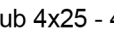
 A-eurosurub 7x50 - 8buc	 D-cuie HDF - 4buc	 I- suport polita - 8buc	 L-capacele autoadezive-8buc
 B- agatator reglabil stanga-1buc	 E-holtzsurub 4x30 - 4buc	 J-cheie imbus 7x50- 1buc	 M-balama -2buc
 C- agatator reglabil dreapta-1buc	 F-holtzsurub 4x18 - 4buc	 K-Surub maner - 2buc	 N-maner-1buc
 G-holtzsurub 4x16 - 4buc	 H-holtzsurub 4x25 - 4buc		

1- Laterală stanga-1buc	4-Placa baza-1buc	7-Usa -1buc
2-Laterală dreapta-1buc	5-Polita mobila (raft)-1buc	8- Spate HDF - 1buc
3-Capac interior - 1buc	6-Polita mobila (raft)-1buc	

- Se cupleaza placa baza 4 de lateralele 1 si 2 cu eurosuruburi A;
- Se gaureste spatele HDF 8 astfel: se dau doua gauri cu freza  $\Phi 25$ , la 9mm de margine (stanga-dreapta) si 25mm de sus in jos;
- Se aseaza spatele HDF 8 in canalul lateralelor 1 si 2 si al placii baza 4, cu gaurile in partea de sus;
- Se cupleaza capacul interior 3 de lateralele 1 si 2 cu eurosuruburi A, dupa care se fixeaza de acesta placa spate HDF folosind cuie HDF D;
- Se fixeaza agatatorii reglabili B si C pe lateralele 1 si 2, in partea de sus a corpului, cu holtzsuruburi E;
- Se bat cu ciocanul suportii polita I in gaurile de pe lateralele 1 si 2, urmand a aseza politele 5 si 6;
- Se monteaza balamalele M pe usa 7 cu holtzsuruburi F;
- Se monteaza placutele balamalelor M cu holtzsuruburi G, pe laterala 1 sau 2(in functie de cum se doreste deschiderea usii) dupa care se strapung gaurile pentru maner cu un burghiu de 4,8 din interior spre exterior;
- Se fixeaza manerul N pe usa 7 cu suruburi K;
- Se aplica capacele L pe eurosuruburile A vizibile.
- Pentru cuplarea corpurilor intre ele se folosesc holtzsuruburile H.









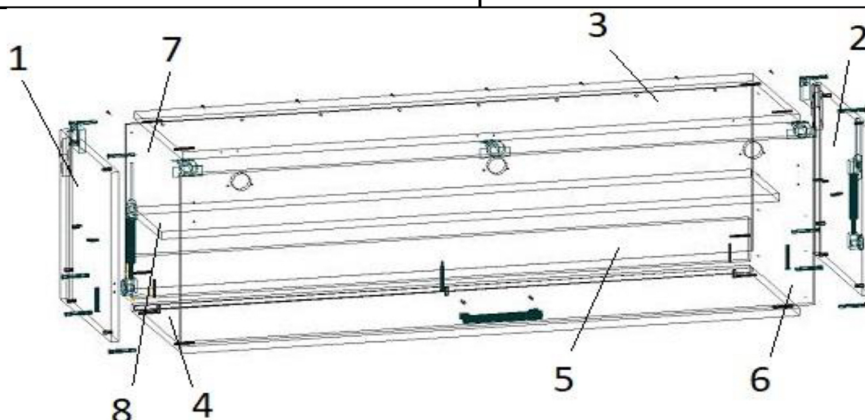
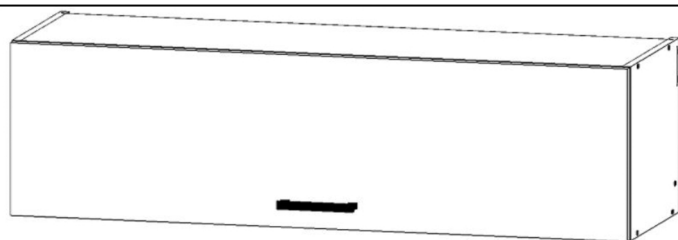



Va rugam sa verificati continutul coletului, existenta accesoriilor de feronerie, precum si a pieselor mentionate in schita de montaj. In cazul constatarii lipsurilor (feronerie, piese) sau defectiunilor va rugam sa anuntati personalul LUX ARTIM in termen de 24 ore de la achizitionarea produsului, comunicand lipsurile si defectiunile constatate si numarul stampilei C.T.C. de pe ambalaj. In cazul necomunicarii defectiunilor sau lipsurilor constatate in termenul de mai sus, SC LUX-ARTIM SRL nu-si asuma raspunderea pentru eventualele neconformitati. Va multumim pentru intelegere.

## CHARM - C9U

CORP SUSPENDAT 1USA ORIZONTALA  
120x36X37

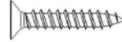
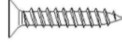

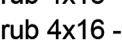
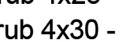
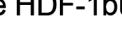
 A-eurosurub 7x50-13buc	 E-agatator regl.dreapta-1buc	 I-telescop 60N-2buc	 L-cheie imbus 7x50 - 1buc
 B-capacele autoadezive-13buc	 F-agatator regl. stanga-1buc	 J-balama - 3buc	 M-maner-1buc
 C-holtzsurub 4x18 - 6buc	 G-holtzsurub 4x25 - 4buc	 K-cuie HDF-8buc	 N-Surub maner - 2buc
 D-holtzsurub 4x16 - 6buc	 H-holtzsurub 4x30 - 4buc	 O-Suport polita-4buc	
1- Laterală stanga-1buc	4-Placa baza-1buc	7-Placa spate HDF-1buc	
2- Laterală dreapta-1buc	5-Plinta-1buc	8-Polita-1buc	
3- Placa capac-1buc	6-Usa-1buc		

1. Se cupleaza lateralele 1 si 2 de placa baza 4, cu eurosuruburi A;
2. Se gaureste spatele HDF 7, cu freza  $\Phi 25$ , la 9mm de margine (stanga-dreapta) si 25mm de sus in jos
3. Se fixeaza spatele HDF 7 in canalul lateralelor 1 si 2 si al placii baza 4;
4. Se cupleaza capacul 3 de lateralele 1 si 2 cu eurosuruburi A, dupa care se fixeaza placa HDF 7 de acesta folosind cuie HDF K;
5. In interiorul corpului, in partea de jos, se fixeaza plinta 5 de lateralele 1, 2 si baza 4 cu eurosuruburi A;
6. In colturile de sus stanga si dreapta se fixeaza agatatorul reglabil F, respectiv E cu holtzsuruburi H;
7. Se bat cu ciocanul suportii polita O, in lateralele 1 si 2, dupa care se pozitioneaza polita 8;
8. Pe lateralele 1 si 2, pe punctari, se fixeaza piesele rotunde ale telescoapelor, cu holtzurile din ambalajul lor;
9. Se monteaza balamalele J pe usa 6 cu holtzsuruburi C;
10. Pe usa 6 se monteaza clemele mai lungi ale telescoapelor I (in stanga, respectiv dreapta, pe punctaje)
11. Se monteaza placutele balamalelor J pe placa capac 3, cu holtzsuruburi D;
12. In clemele fixate pe usa 6 si lateralele 1 si 2 se cupleaza telescopul I;
13. Se fixeaza manerul M pe usa 6 cu suruburile de maner N
14. Pentru cuplarea corpurilor intre ele (stanga-dreapta) puteti folosi holtzsuruburile G.







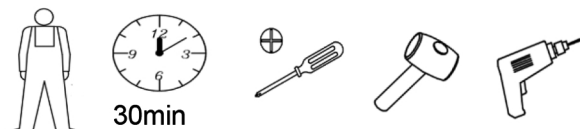



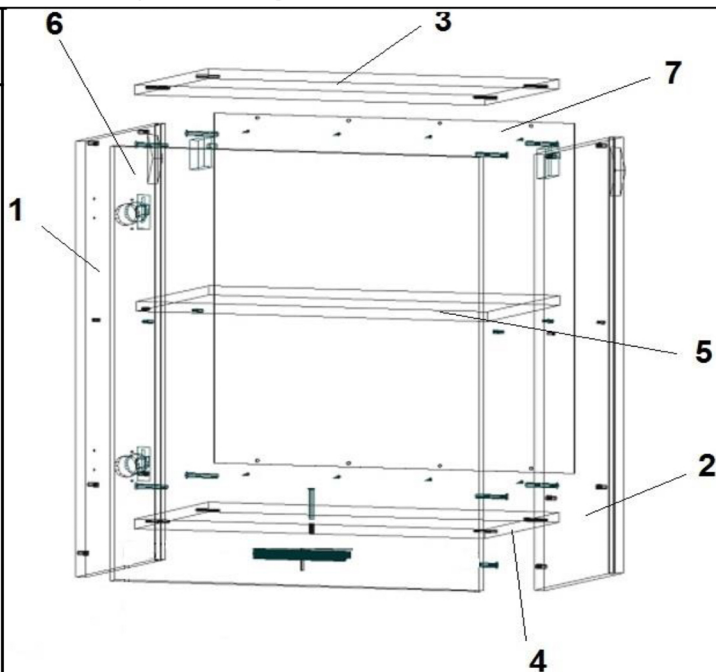
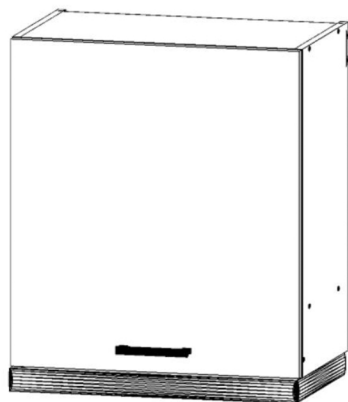

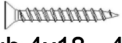

Va rugam sa verificati continutul coletului, existenta accesoriilor de feronerie, precum si a pieselor mentionate in schita de montaj. In cazul constatarii lipsurilor (feronerie, piese) sau defectiunilor va rugam sa anuntati personalul LUX ARTIM in termen de 24 ore de la achizitionarea produsului, comunicand lipsurile si defectiunile constatate si numarul stampilei C.T.C. de pe ambalaj. In cazul necomunicarii defectiunilor sau lipsurilor constatate in termenul de mai sus, SC LUX-ARTIM SRL nu-si asuma raspunderea pentru eventualele neconformitati. Va multumim pentru intelegere.

**CHARM - C10S**  
CORP SUSPENDAT HOTA 1USA 60X72X37



30min



 A-eurosurub 7x50 - 8buc	 D-holtzsurub 4x18 - 4buc E-holtzsurub 4x16 - 4buc F-holtzsurub 4x25 - 4buc G-holtzsurub 4x30 - 4buc	 I-maner banda - 1buc	 L-holtzsurub 3.5x16- 2buc
 B-agatator reglabil stanga-1buc		 J-Cuie HDF-8buc	 M-cheie imbus 7x50- 1buc
 C-agatator reglabil dreapta-1buc	 H-balama - 2buc	 K-Suport polita-4buc	 N-capacele autoadezive-8buc
1- Laterala stanga-1buc 2-Laterala dreapta-1buc 3-Capac interior - 1buc	4-Polita fixa-1buc 5-Polita mobila (raft)-1buc 6-Usa-1buc	7-HDF-1buc	

1. Se cupleaza polita fixa 4 de lateralele 1 si 2 cu eurosuruburi A;
- 2.Placa HDF 7 se gaureste in partea de sus cu o freza de  $\Phi 25$  la 25mm de sus in jos si la 9mm de la margine (stanga-dreapta), dupa care se introduc pe canal;
- 3.Se cupleaza capac interior 3 de lateralele 1 si 2 cu eurosuruburi A;
4. Pe laterala stanga 1 si dreapta 2 se fixeaza agatatorii reglabili B si C in partea de sus a corpului cu holtzsuruburi G;
- 5.Se fixeaza HDF 7 de capac interior 3 si polita fixa 4, folosind cuie HDF J;
6. Se gaureste polita fixa 4 in functie de tubulatura hotei, apoi se fixeaza hota;
- 7.Se bat cu ciocanul suportii de polita K pe laturile 1 si 2, dupa care se aseaza polita mobila 5;
8. Se monteaza balamalele H pe usa 6, folosind holtzsuruburi D;
- 9.Se monteaza placutele balamalelor pe laterala stanga 1, cu holtzsuruburi E;
10. Se fixeaza manerul I pe cantul usii 6 (pe latura de jos) folosind holtzsuruburile de maner L;
- 11.Se aplica capacele N pe toate eurosuruburile A vizibile.
- 12.Pentru cuplarea corpurilor intre ele se folosesc holtzsuruburi F.



Interior pentru  
o stare de bine

SC LUX-ARTIM SRL  
STR.AVANTULUI NR.11,ONESTI,BACAU  
TEL.:0234317940, office@luxartim.ro  
[www.luxartim.ro](http://www.luxartim.ro)

Va rugam sa verificati continutul coletului, existenta accesoriilor de feronerie, precum si a pieselor mentionate in schita de montaj. In cazul constatarii lipsurilor (feronerie, piese) sau defectiunilor va rugam sa anuntati personalul LUX ARTIM in termen de 24 ore de la achizitionarea produsului, comunicand lipsurile si defectiunile constatate si numarul stampilei C.T.C. de pe ambalaj. In cazul necomunicarii defectiunilor sau lipsurilor constatate in termenul de mai sus, SC LUX-ARTIM SRL nu-si asuma raspunderea pentru eventualele neconformitati. Va multumim pentru intelegere.

### CHARM - C12N CORP BAZA 3SERTARE 90x84x54,3

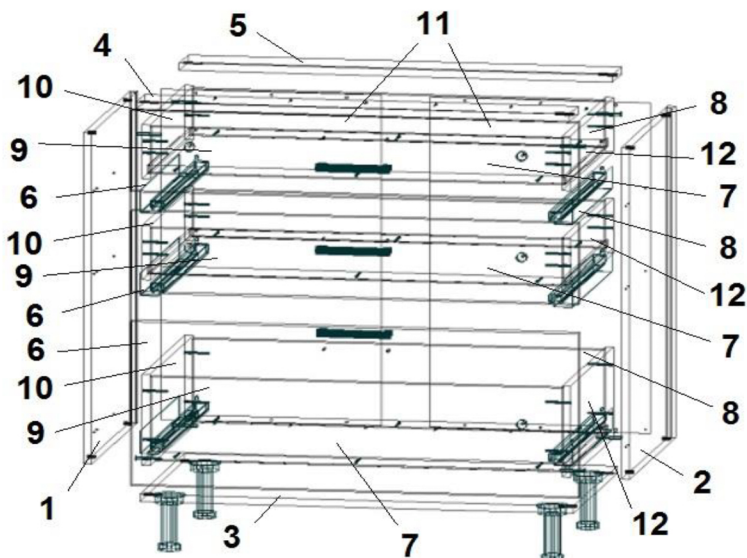
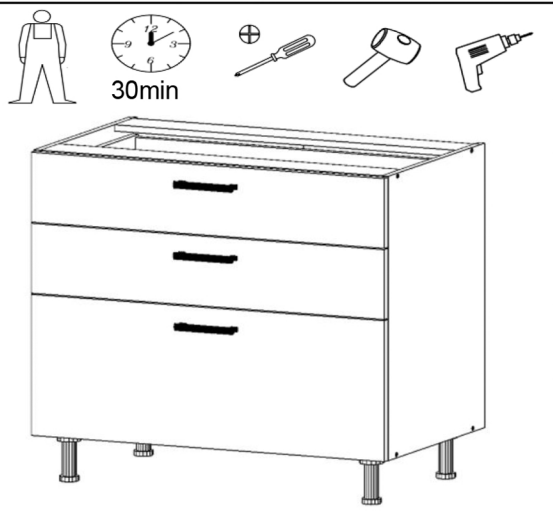

A-eurosurub 7x50 - 8buc B-eurosurub 5x50 -42buc	F-set tandem500-3seturi	I-maner - 3buc	L-capacele autoadezive-8buc
C-holtzsurub 4x18 -16buc D-holtzsurub 4x16 -60buc	G-picior plastic 120 - 4buc	J-element reglare front-6buc	M-profil imbinare HDF-1buc
E-holtzsurub 4x25 - 4buc	H-cuie HDF -12buc	K-Surub maner - 6buc	N-surub element reglare front-6buc

O-cheie imbus 7x50-1buc

P-cheie imbus 5x50-1buc

1- Laterală stanga-1buc	5-Lonjeron spate-1buc	9-Fata interior sertar-3buc
2-Laterală dreapta-1buc	6-Front sertar-3buc	10-Laterală sertar stanga-3buc
3-Placa baza-1buc	7-Baza sertar-3buc	11-Spate Hdf-2buc
4-Lonjeron fata-1buc	8-Spate interior sertar-3buc	12-Laterală sertar dreapta-3buc

- Se cupleaza placa baza 3 de lateralele 1 si 2 cu eurosuruburi A;
- Se fixeaza lonjeron fata 4 cu lateralele 1 si 2 cu eurosuruburi A;
- Se aseaza in canalul lateralelor 1 si 2 cele 2buc spate HDF 11, se taie colturile pe laturile care intra pe canal sus si jos, apoi se cupleaza intre ele cu profil imbinare HDF M
- Se cupleaza lonjeron spate 5 de lateralele 1 si 2 cu eurosuruburi A
- Se prind cele 2buc spate HDF 11 de lonjeron spate 5 si placa baza 3, folosind cuie HDF H;
- Pe placa baza 3, la 4cm de marginea din fata respectiv din spate, se prind picioarele G cu holtzsuruburi C, pe linia lateralelor 1 si 2 pentru a evita ruperea placii de baza;
- Se fixeaza setul tandem F pe lateralele 1 si 2 in punctaje, cu holtzsuruburile D;
- Se cupleaza fata interior sertar 9 de lateralele stanga sertar 10 si dreapta sertar 12 cu eurosuruburi B. Apoi se introduce pe canal placa baza sertar 7, dupa care se prinde spate interior sertar 8;
- In partea din fata a sertarului astfel asamblat, pe placa baza se fixeaza cuplaje stanga si dreapta cu holtzsuruburi D, dupa care se aseaza pe sinele montate si se inchide sa faca clic;
- In gaurile de pe spatele fronturilor sertar 6 se fixeaza batand cu ciocanul elementul de reglare front J
- Se prind, pornind de jos in sus, fronturile sertarelor 6 cu suruburile N elementele reglare front, prin interior sertar de fata sertar. La fronturile din mijloc si sus se prind manerele inainte de prinderea frontului de sertar, folosind surub maner K, dupa ce pe partea din spate se frezeaza pentru a ingropa capul surubului
- Se aplica capacele L pe eurosuruburile vizibile.





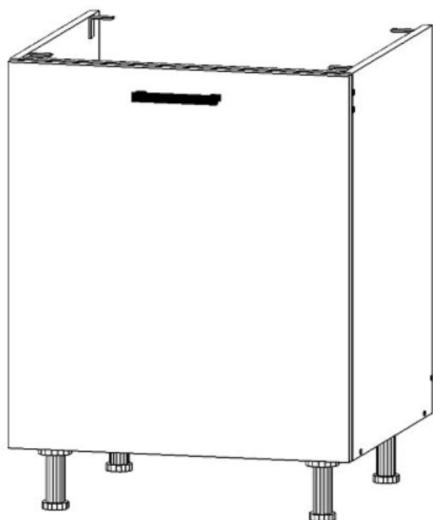



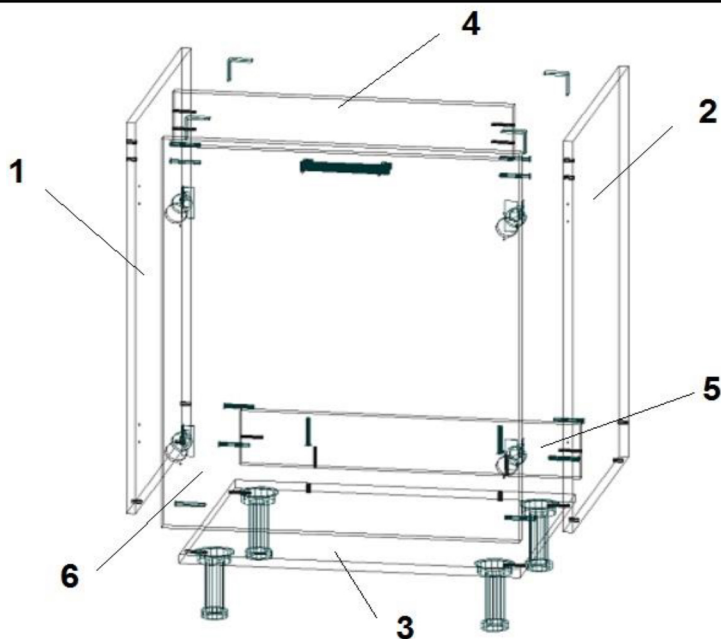

Va rugam sa verificati continutul coletului, existenta accesoriilor de feronerie, precum si a pieselor mentionate in schita de montaj. In cazul constatarii lipsurilor (feronerie, piese) sau defectiunilor va rugam sa anuntati personalul LUX ARTIM in termen de 24 ore de la achizitionarea produsului, comunicand lipsurile si defectiunile constatate si numarul stampilei C.T.C. de pe ambalaj. In cazul necomunicarii defectiunilor sau lipsurilor constatate in termenul de mai sus, SC LUX-ARTIM SRL nu-si asuma raspunderea pentru eventualele neconformitati. Va multumim pentru intelegere.

**CHARM - C1S**  
**MASCA CHIUVETA 1USA 60x84x54.3**

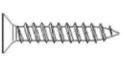

30min



 A-eurosurub 7x50 - 12buc	 D-picior plastic 120 - 4buc	 G-holtzsurub 4x16 - 20buc	 J-capacele autoadezive-10buc
 B-maner banda - 1buc	 E-coltar Zn 40x40-4buc	 H-holtzsurub 4x25 - 4buc	 K-Holtzsurub 3.5x16 - 2buc
 C-balama - 2buc	 F-holtzsurub 4x18 - 20buc	 I-cheie imbus 7x50-1buc	

1-Laterala stanga-1buc	4-Lonjeron fata sus-1buc
2-Laterala dreapta-1buc	5-Lonjeron spate jos-1buc
3-Placa baza-1buc	6-Usa -1buc

1. Se cupleaza placa baza 3 de lateralele 1 si 2 cu eurosuruburi A;
  2. Se fixeaza lonjeroanele fata sus 4 si spate jos 5 de lateralele 1 si 2 cu eurosuruburi A;
  3. Se fixeaza picioarele D pe placa baza 3 cu holtzsuruburi F, la distanta de 4cm de marginea din fata respectiv spate, pe linia lateralelor, pentru a evita ruperea placii de baza;
  4. Se monteaza balamalele C pe usa 6 cu holtzsuruburi F;
  5. Se monteaza bratul balamalei F folosind holtzsuruburi G, pe laterala 1 sau 2 (dupa cum se doreste deschiderea usii), dupa care se strapung gaurile pentru maner cu un burghiu de 4,8 din interior spre exterior;
  6. Se fixeaza manerul B pe cantul usii 6, cu holtzsuruburi de maner K, pastrand 5cm de la margine;
  7. Se aplica capacele autoadezive J pe eurosuruburile A vizibile;
  8. Se fiseaza coltarele Zn E pe lateralele 1 si 2 cu holtzsuruburi G;
  9. Holtzsuruburile H pot fi folosite pentru cuplarea corpurilor intre ele;
- Dupa montare, recomandam aplicarea unui cordon de silicon intre laterale si placa baza.







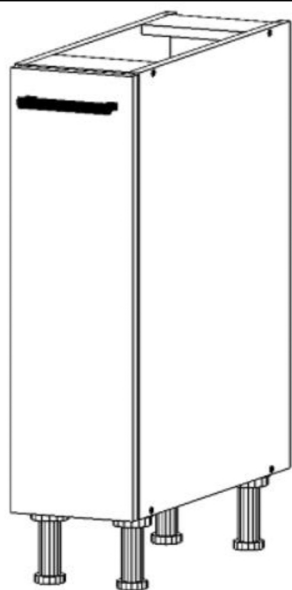



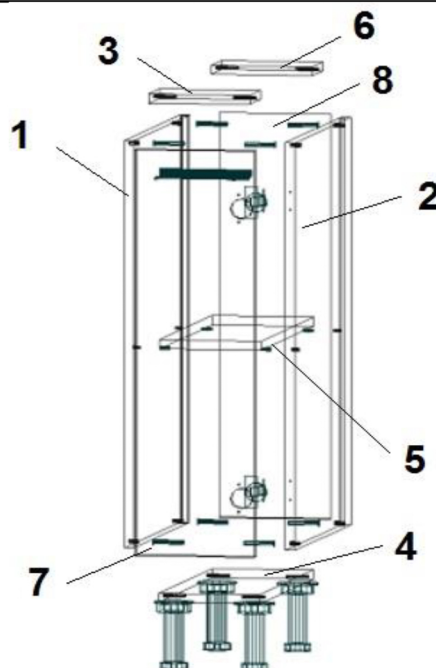

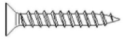

Va rugam sa verificati continutul coletului, existenta accesoriilor de feronerie, precum si a pieselor mentionate in schita de montaj. In cazul constatarii lipsurilor (feronerie, piese) sau defectiunilor va rugam sa anuntati personalul LUX ARTIM in termen de 24 ore de la achizitionarea produsului, comunicand lipsurile si defectiunile constatate si numarul stampilei C.T.C. de pe ambalaj. In cazul necomunicarii defectiunilor sau lipsurilor constatate in termenul de mai sus, SC LUX-ARTIM SRL nu-si asuma raspunderea pentru eventualele neconformitati. Va multumim pentru intelegere.

**CHARM - C2D**  
CORP BAZA 1USA 1RAFT 20x84x54,3



30min





 A-eurosurub 7x50 - 8buc	 D-holtzsurub 4x16 - 4buc	 G-maner - 1buc	 J-holtzsurub 4x25 - 4buc
 B-cuie HDF - 4buc	 E-picior plastic - 4buc	 H-balama - 2buc	 K-cheie imbus 7x50 - 1buc
 C-holtzsurub 4x18-20buc	 F- suport polita - 4buc	 I-surub maner - 2buc	 L-capacele autoadezive-8buc
1- Laterala stanga-1buc 2-Laterala dreapta-1buc 3-Lonjeron fata-1buc	4-Placa baza-1buc 5-Polita mobila-1buc 6-Lonjeron spate-1buc	7-Usa-1buc 8-Spate HDF-1buc	

1. Se cupleaza placa baza 4 de lateralele 1 si 2 cu eurosuruburi A;
2. Se aseaza placa spate HDF 8 in canalul de pe lateralele 1 si 2;
3. Se cupleaza lonjeroanele fata 3 si spate 6 de lateralele 1 si 2, folosind eurosuruburi A;
4. Se fixeaza placa spate HDF 8 de lonjeronul spate 6 si placa baza 4, folosind cuie HDF, B;
5. Pe placa baza 4, la 4cm de marginea din fata respectiv din spate, se prind picioarele E cu holtzsuruburi C, pe linia lateralelor pentru a evita ruperea placii de baza;
6. Se bat cu ciocanul suportii de polita F in gaurile de pe lateralele 1 si 2, dupa care se aseaza polita 5;
7. Se monteaza balamalele H pe usa 7 cu holtzsuruburi C
8. Se monteaza placutele balamalelor H, cu holtzsuruburi D, pe laterala 1 sau 2 (dupa cum doriti deschiderea), dupa care se gaureste pentru maner cu un burghiu de 4,8 din interior spre exterior;
9. Se fixeaza manerul G pe usa 7 cu suruburile I;
10. Se aplica capacelele autoadezive pe toate eurosuruburile A vizibile.

Va rugam sa verificati continutul coletului, existenta accesoriilor de feronerie, precum si a pieselor mentionate in schita de montaj. In cazul constatarii lipsurilor (feronerie, piese) sau defectiunilor va rugam sa anuntati personalul LUX ARTIM in termen de 24 ore de la achizitionarea produsului, comunicand lipsurile si defectiunile constatate si numarul stampilei C.T.C. de pe ambalaj. In cazul necomunicarii defectiunilor sau lipsurilor constatate in termenul de mai sus, SC LUX-ARTIM SRL nu-si asuma raspunderea pentru eventualele neconformitati. Va multumim pentru intelegere.

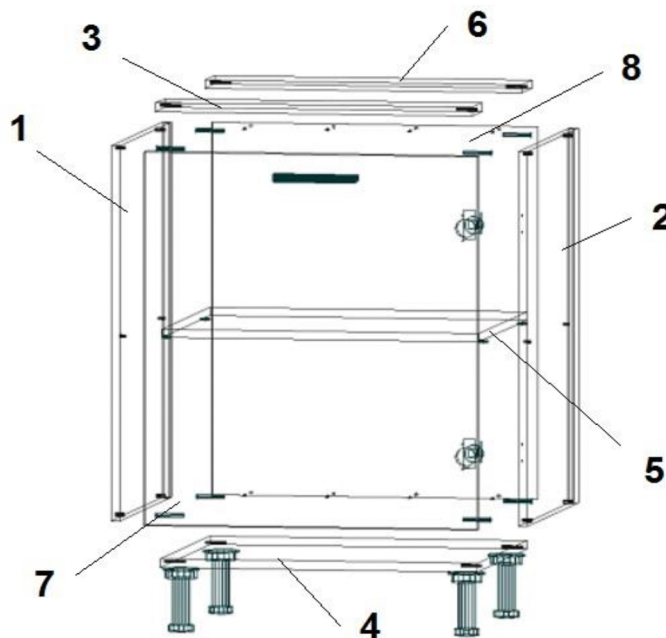
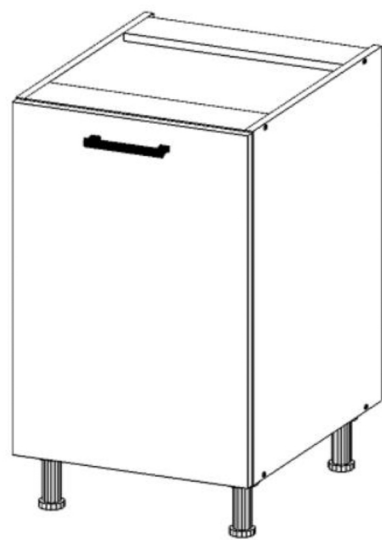
**CHARM - C2S**  
CORP BAZA 1USA 1RAFT 60x84x54,3



 A-eurosurub 7x50 - 8buc	 D-holtzsurub 4x16 - 4buc	 G- suport polita - 4buc	 J-Surub maner - 2buc
 B-cuie HDF - 8buc	 E-holtzsurub 4x25 - 4buc	 H-maner - 1buc	 K-cheie imbus 7x50 - 1buc
 C-holtzsurub 4x18 - 20buc	 F plastic - 4buc	 I-balama - 2buc	 L-capacele autoadezive-8buc

1- Laterala stanga-1buc	4-Placa baza-1buc	7-Usa-1buc
2-Laterala dreapta-1buc	5-Polita mobila-1buc	8-Placa spate HDF1buc
3-Lonjeron fata-1buc	6-Lonjeron spate-1buc	

1. Se cupleaza placa baza 4 de lateralele 1 si 2 cu eurosuruburi A;
2. Se aseaza placa spate HDF 8 in canalul de pe lateralele 1 si 2;
3. Se cupleaza lonjeroanele fata 3 si spate 6 de lateralele 1 si 2, folosind eurosuruburi A;
4. Se fixeaza placa spate HDF 8 de lonjeronul spate 6 si placa baza 7, folosind cuie HDF B;
5. Pe placa baza 4, la 4cm din fata respectiv din spate, se prind picioarele F cu holtzsuruburi C, pe linia lateralelor pentru a evita ruperea placii de baza;
6. Se bat cu ciocanul suportii de polita G in gaurile de pe lateralele 1 si 2, dupa care se aseaza polita 5;
7. Se monteaza balamalele I pe usa 7 cu holtzsuruburi C;
8. Se monteaza bratul balamalei H, cu holtzsuruburi D, pe laterala 1 sau 2 (dupa cum doriti deschiderea), dupa care se gaureste pentru maner cu un burghiu de 4,8 din interior spre exterior;
9. Se fixeaza manerul H pe usa 7 cu suruburile J;
10. Se aplica capacelele autoadezive pe toate eurosuruburile A vizibile;
11. Holtzsuruburile E pot fi folosite pentru cuplajul corpurilor intre ele.





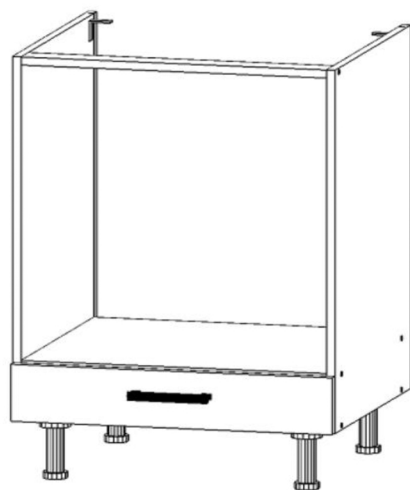



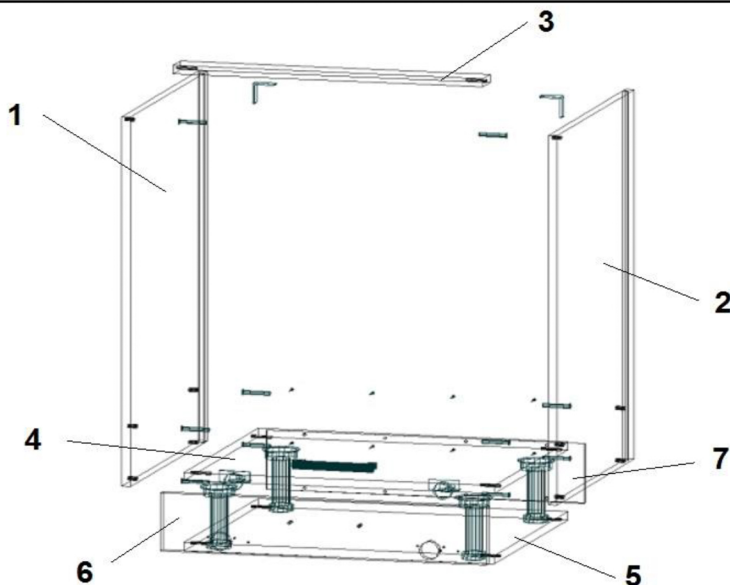

Va rugam sa verificati continutul coletului, existenta accesoriilor de feronerie, precum si a pieselor mentionate in schita de montaj. In cazul constatarii lipsurilor (feronerie, piese) sau defectiunilor va rugam sa anuntati personalul LUX ARTIM in termen de 24 ore de la achizitionarea produsului, comunicand lipsurile si defectiunile constatate si numarul stampilei C.T.C. de pe ambalaj. In cazul necomunicarii defectiunilor sau lipsurilor constatate in termenul de mai sus, SC LUX-ARTIM SRL nu-si asuma raspunderea pentru eventualele neconformitati. Va multumim pentru intelegere.

### CHARM - C4S CORP CUPTOR 1USA 60x84x54,3



30min



 A-eurosurub 7x50 - 10buc	 D-picioar plastic - 4buc	 G-holtzsurub 4x18 - 20buc H-holtzsurub 4x16 - 12buc I-holtzsurub 4x25 - 4buc	 K-Holtzsurub 3.5x16 - 2buc
 B-balama - 2buc	 E-maner banda - 1buc		 L-capacele autoadezive- 10buc
 C-cuie HDF-8buc	 F-coltar Zn 40x40 - 2buc	 J-cheie imbus 7x50 - 1buc	

1- Laterala stanga-1buc

4-Polita fixa-1buc

7-HDF-1buc

2-Laterala dreapta-1buc

5-Placa baza-1buc

3-Lonjeron fata-1buc

6-Usa-1buc

1. Se cupleaza placa baza 5 de lateralele stanga 1 si dreapta 2 cu eurosuruburi A;
2. Se fixeaza lonjeron fata 3 de lateralele 1 si 2 cu eurosuruburi A;
3. Se fixeaza HDF 7 in canalul lateralelor 1 si 2;
4. Se monteaza balamalele B pe usa 6 folosind holtzsuruburi G;
5. Se monteaza placutele balamalelor B pe placa baza 5, folosind holtzsuruburi H;
6. Se fixeaza polita 4 de lateralele stanga 1 si dreapta 2 cu eurosuruburi A;
7. Se fixeaza HDF 7 de placa baza 5 si polita fixa 4, folosind cuie HDF C;
8. Se fixeaza picioarele D pe placa baza 5, cu holtzsuruburi G, la 4cm de marginea din fata, respectiv din spate, pe linia lateralelor, pentru a evita ruperea placii de baza;
9. Se fixeaza manerul E pe cantul usii 6, cu holtzsuruburile maner K, pastrand 5cm de la margine;
10. Se fixeaza coltarele Zn F in partea din spate a corpului cu holtzsuruburi H;
11. Se aplica capacelele autoadezive pe toate eurosuruburile A vizibile.
12. Pentru cuplarea corpurilor intre ele se folosesc holtzsuruburi I.



Va rugam sa verificati continutul coletului, existenta accesoriilor de feronerie, precum si a pieselor mentionate in schita de montaj. In cazul constatarii lipsurilor (feronerie, piese) sau defectiunilor va rugam sa anuntati personalul LUX ARTIM in termen de 24 ore de la achizitionarea produsului, comunicand lipsurile si defectiunile constatate si numarul stampilei C.T.C. de pe ambalaj. In cazul necomunicarii defectiunilor sau lipsurilor constatate in termenul de mai sus, SC LUX-ARTIM SRL nu-si asuma raspunderea pentru eventualele neconformitati. Va multumim pentru intelegere.

## CHARM - C5U







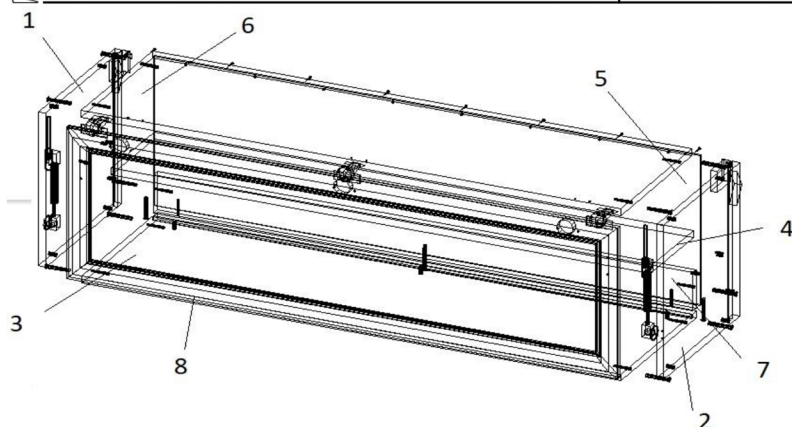
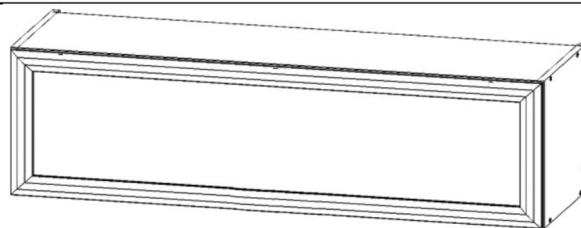





### CORP SUSPENDAT 1USA VERTICALA STICLA120x36x37



30min



- 1- Laterala stanga-1buc
- 2- Laterala dreapta-1buc
- 3- Placa baza-1buc
- 4- Polita pal-1buc
- 5- Spate HDF-1buc
- 6- Placa capac -1buc
- 7- Plinta - 1buc

 A-eurosurub 7x50 - 13buc	 D- Piston 60N - 2buc	 G-holtzsurub 4x30 - 4buc H-holtzsurub 4x18 - 6buc	 L-holtzsurub 3.5x16 - 4buc
 B-element corp susp.Blum stanga-1buc	 E- Suport polita - 4buc	 I-holtzsurub 4x16 - 6buc J-holtzsurub 4x25 - 4buc	 L-cheie imbus 7x50 - 1buc
 C-element corp susp.Blum dreapta-1buc	 F-cuie HDF 2x20 -8buc	 K-capacele autoadezive-13buc	 M-push open cant -1buc

1. Se cupleaza lateralele 1 si 2 de placa baza 3, cu eurosuruburi A;
2. Pe spatele HDF 5, se dau doua gauri cu freza  $\Phi 25$ , la 9mm de margine (stanga-dreapta) si 25mm de sus in jos, apoi se elimina cercul format;
3. Se fixeaza spatele HDF 5 in canalul lateralelor 1 si 2 si al placii baza 3, cu gaurile in partea de sus;
4. Se cupleaza capacul 6 de lateralele 1 si 2 cu eurosuruburi A, apoi se fixeaza placa HDF 5 de aceasta, folosind cuie HDF F;
5. In interiorul corpului, in partea de jos, se fixeaza plinta 7 de lateralele 1, 2 si baza 4 cu eurosuruburi A;
6. In colturile de sus stanga si dreapta se fixeaza elementele corp suspendat Blum B, respectiv C respectiv E cu holtzsuruburi G;
7. Se bat cu ciocanul suportii polita E in lateralele 1 si 2, dupa care se pozitioneaza polita 4
8. Pe lateralele 1 si 2, pe punctari, se fixeaza piesele rotunde ale telescoapelor, cu holtzurile din ambalajul lor;
9. Se fixeaza push openul M in gaura din cantul placii baza 3;
10. Se fixeaza usa de sticla cu rama profil aluminiu 8 pe punctajele de pe placa capac 6, folosind holtzsuruburi H;
11. In clemele fixate pe usa 8 si lateralele 1 si 2 se cupleaza pistoanele 60N D
12. Pentru cuplarea corpurilor intre ele (stanga-dreapta) se recomanda folosirea holtzsuruburilor J.