

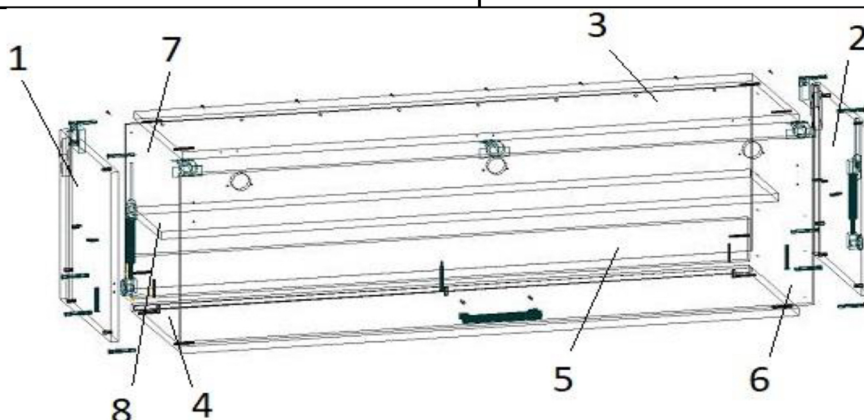

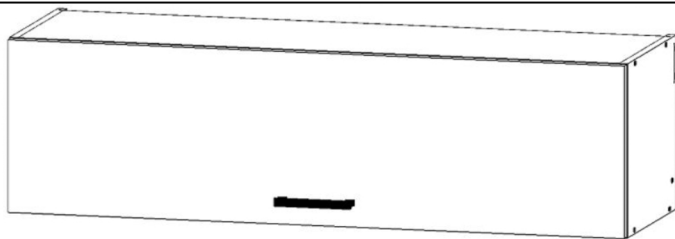







Va rugam sa verificati continutul coletului, existenta accesoriilor de feronerie, precum si a pieselor mentionate in schita de montaj. In cazul constatarii lipsurilor (feronerie, piese) sau defectiunilor va rugam sa anuntati personalul LUX ARTIM in termen de 24 ore de la achizitionarea produsului, comunicand lipsurile si defectiunile constatate si numarul stampilei C.T.C. de pe ambalaj. In cazul necomunicarii defectiunilor sau lipsurilor constatate in termenul de mai sus, SC LUX-ARTIM SRL nu-si asuma raspunderea pentru eventualele neconformitati. Va multumim pentru intelegere.

CHARM - C9U

CORP SUSPENDAT 1USA ORIZONTALA
120x36X37

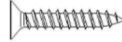
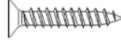

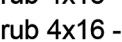
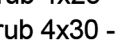
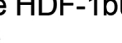
 A-eurosurub 7x50-13buc	 E-agatator regl.dreapta-1buc	 I-telescop 60N-2buc	 L-cheie imbus 7x50 - 1buc
 B-capacele autoadezive-13buc	 F-agatator regl. stanga-1buc	 J-balama - 3buc	 M-maner-1buc
 C-holtzsurub 4x18 - 6buc	 G-holtzsurub 4x25 - 4buc	 K-cuie HDF-8buc	 N-Surub maner - 2buc
 D-holtzsurub 4x16 - 6buc	 H-holtzsurub 4x30 - 4buc	 O-Suport polita-4buc	
1- Laterală stanga-1buc	4-Placa baza-1buc	7-Placa spate HDF-1buc	
2- Laterală dreapta-1buc	5-Plinta-1buc	8-Polita-1buc	
3- Placa capac-1buc	6-Usa-1buc		

- Se cupleaza lateralele 1 si 2 de placa baza 4, cu eurosuruburi A;
- Se gaureste spatele HDF 7, cu freza $\Phi 25$, la 9mm de margine (stanga-dreapta) si 25mm de sus in jos
- Se fixeaza spatele HDF 7 in canalul lateralelor 1 si 2 si al placii baza 4;
- Se cupleaza capacul 3 de lateralele 1 si 2 cu eurosuruburi A, dupa care se fixeaza placa HDF 7 de acesta folosind cuie HDF K;
- In interiorul corpului, in partea de jos, se fixeaza plinta 5 de lateralele 1, 2 si baza 4 cu eurosuruburi A;
- In colturile de sus stanga si dreapta se fixeaza agatatorul reglabil F, respectiv E cu holtzsuruburi H;
- Se bat cu ciocanul suportii polita O, in lateralele 1 si 2, dupa care se pozitioneaza polita 8;
- Pe lateralele 1 si 2, pe punctari, se fixeaza piesele rotunde ale telescoapelor, cu holtzurile din ambalajul lor;
- Se monteaza balamalele J pe usa 6 cu holtzsuruburi C;
- Pe usa 6 se monteaza clemele mai lungi ale telescoapelor I (in stanga, respectiv dreapta, pe punctaje)
- Se monteaza placutele balamalelor J pe placa capac 3, cu holtzsuruburi D;
- In clemele fixate pe usa 6 si lateralele 1 si 2 se cupleaza telescopul I;
- Se fixeaza manerul M pe usa 6 cu suruburile de maner N
- Pentru cuplarea corpurilor intre ele (stanga-dreapta) puteti folosi holtzsuruburile G.



Interior pentru
o stare de bine

SC LUX-ARTIM SRL
STR.AVANTULUI NR.11,ONESTI,BACAU
TEL.:0234317940, office@luxartim.ro
www.luxartim.ro

Va rugam sa verificati continutul coletului, existenta accesoriilor de feronerie, precum si a pieselor mentionate in schita de montaj. In cazul constatarii lipsurilor (feronerie, piese) sau defectiunilor va rugam sa anuntati personalul LUX ARTIM in termen de 24 ore de la achizitionarea produsului, comunicand lipsurile si defectiunile constatate si numarul stampilei C.T.C. de pe ambalaj. In cazul necomunicarii defectiunilor sau lipsurilor constatate in termenul de mai sus, SC LUX-ARTIM SRL nu-si asuma raspunderea pentru eventualele neconformitati. Va multumim pentru intelegere.

CHARM - C12N CORP BAZA 3SERTARE 90x84x54,3

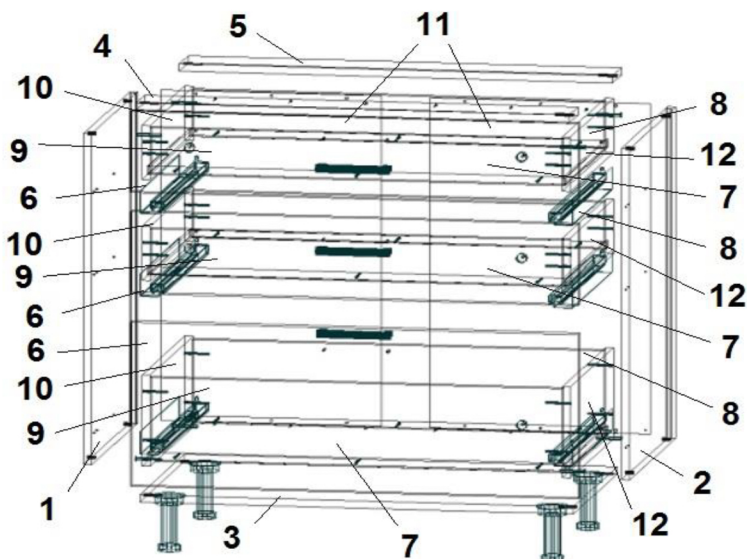
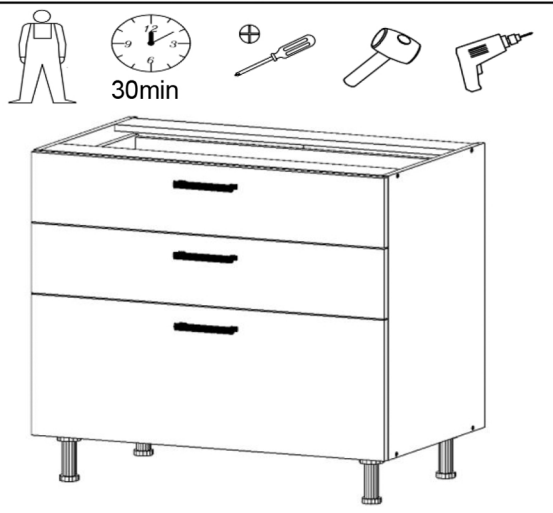

A-eurosurub 7x50 - 8buc B-eurosurub 5x50 -42buc	F-set tandem500-3seturi	I-maner - 3buc	L-capacele autoadezive-8buc
C-holtzsurub 4x18 -16buc D-holtzsurub 4x16 -60buc	G-picior plastic 120 - 4buc	J-element reglare front-6buc	M-profil imbinare HDF-1buc
E-holtzsurub 4x25 - 4buc	H-cuie HDF -12buc	K-Surub maner - 6buc	N-surub element reglare front-6buc

O-cheie imbus 7x50-1buc

P-cheie imbus 5x50-1buc

1- Laterală stanga-1buc	5-Lonjeron spate-1buc	9-Fata interior sertar-3buc
2-Laterală dreapta-1buc	6-Front sertar-3buc	10-Laterală sertar stanga-3buc
3-Placa baza-1buc	7-Baza sertar-3buc	11-Spate Hdf-2buc
4-Lonjeron fata-1buc	8-Spate interior sertar-3buc	12-Laterală sertar dreapta-3buc

- Se cupleaza placa baza 3 de lateralele 1 si 2 cu eurosuruburi A;
- Se fixeaza lonjeron fata 4 cu lateralele 1 si 2 cu eurosuruburi A;
- Se aseaza in canalul lateralelor 1 si 2 cele 2buc spate HDF 11, se taie colturile pe laturile care intra pe canal sus si jos, apoi se cupleaza intre ele cu profil imbinare HDF M
- Se cupleaza lonjeron spate 5 de lateralele 1 si 2 cu eurosuruburi A
- Se prind cele 2buc spate HDF 11 de lonjeron spate 5 si placa baza 3, folosind cuie HDF H;
- Pe placa baza 3, la 4cm de marginea din fata respectiv din spate, se prind picioarele G cu holtzsuruburi C, pe linia lateralelor 1 si 2 pentru a evita ruperea placii de baza;
- Se fixeaza setul tandem F pe lateralele 1 si 2 in punctaje, cu holtzsuruburile D;
- Se cupleaza fata interior sertar 9 de lateralele stanga sertar 10 si dreapta sertar 12 cu eurosuruburi B. Apoi se introduce pe canal placa baza sertar 7, dupa care se prinde spate interior sertar 8;
- In partea din fata a sertarului astfel asamblat, pe placa baza se fixeaza cuplaje stanga si dreapta cu holtzsuruburi D, dupa care se aseaza pe sinele montate si se inchide sa faca clic;
- In gaurile de pe spatele fronturilor sertar 6 se fixeaza batand cu ciocanul elementul de reglare front J
- Se prind, pornind de jos in sus, fronturile sertarelor 6 cu suruburile N elementele reglare front, prin interior sertar de fata sertar. La fronturile din mijloc si sus se prind manerele inainte de prinderea frontului de sertar, folosind surub maner K, dupa ce pe partea din spate se frezeaza pentru a ingropa capul surubului
- Se aplica capacele L pe eurosuruburile vizibile.

Va rugam sa verificati continutul coletului, existenta accesoriilor de feronerie, precum si a pieselor mentionate in schita de montaj. In cazul constatarii lipsurilor (feronerie, piese) sau defectiunilor va rugam sa anuntati personalul LUX ARTIM in termen de 24 ore de la achizitionarea produsului, comunicand lipsurile si defectiunile constatate si numarul stampilei C.T.C. de pe ambalaj. In cazul necomunicarii defectiunilor sau lipsurilor constatate in termenul de mai sus, SC LUX-ARTIM SRL nu-si asuma raspunderea pentru eventualele neconformitati. Va multumim pentru intelegere.

CHARM - C19S CORP TURN CUPTOR 60x57x215.6

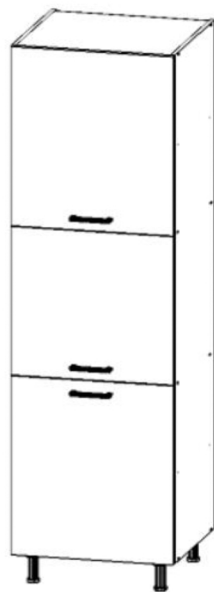

120min



- 1- Laterala stanga-1buc
- 2-Laterala dreapta-1buc
- 3-Capac interior-1buc
- 4-Polita fixa - 1buc
- 5-Polita fixa-1buc
- 6-Placa baza-1buc
- 7-Polita mobila-1buc
- 8-HDF-1buc
- 9-HDF-1buc
- 10-HDF-1buc
- 11-Polita mobila-1buc
- 12-Usa-1buc
- 13-Usa-1buc
- 14-Usa-1buc

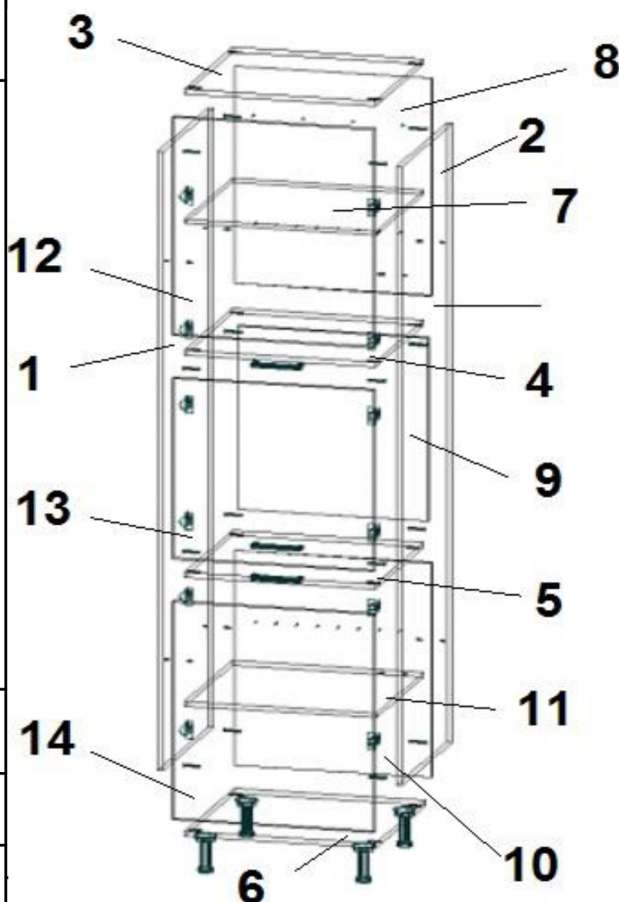

 A-eurosurub 7x50 - 16buc

 F-maner - 3buc

 B-holtzsurub 4x18- 28buc

 G- picioar- 4buc

C-holtzsurub 4x16 -12buc
D-holtzsurub 4x25 - 8buc

 H-suport polita - 8buc

 E-balama - 6buc

 I-cuie HDF -20buc

 K-surub maner - 4buc

 J-cheie imbus 7x50 - 1buc

 L-capacele autoadezive-16buc

1. Se cupleaza placa baza 6 de lateralele 1 si 2 cu eurosuruburi A;
2. Se fixeaza in canalul de pe lateralele 1 si 2 cele 3 bucati HDF, 10 cea de jos, 9 cea de la mijloc si 8 de sus;
3. Se fixeaza placa capac 3 de lateralele 1 si 2, folosind eurosuruburi A;
4. Se fixeaza politele fixe 4 si 5 de lateralele 1 si 2 folosind eurosuruburi A;
5. Placile HDF 8, 9 si 10 se fixeaza folosind cuie HDF I, de capac 3, placa baza 6 si politele fixe 4 si 5;
6. Pe placa baza 6, la 4cm de la marginea din fata, respectiv spate, se monteaza picioarele G, folosind holtzsuruburi B, pe linia lateralelor pentru a evita ruperea placii de baza;
7. Se fixeaza in gaurile de pe lateralele 1 si 2 suportii de polita H, dupa care se aseaza politele mobile 7 si 11;
8. Se monteaza balamalele E pe usile 12, 13 si 14 cu holtzsuruburi B
9. Se monteaza bratul balamalelor E, cu holtzsuruburi C, pe laterala 1 sau 2 (in functie de cum se doreste deschiderea), dupa care se strapunge pentru maner cu un burghiu de 4,8 din interior spre exterior;
10. Se fixeaza manerele F pe usile 12, 13 si 14 cu suruburile K;
11. Se aplica capacelele autoadezive L pe toate eurosuruburile A vizibile.
12. Usa din mijloc 13, poate fi anulata in vederea introducerii unui cuptor.
13. Holtzsuruburile D, de 4x25, se folosesc pentru cuplarea corpurilor intre ele.

CHARM - C20S

CORP TURN 1USA 60x215,6x57

VERSIUNEA: 1/23.10.2022

Va rugam sa verificati continutul coletului, existenta accesoriilor de feronerie, precum si a pieselor mentionate in schita de montaj. In cazul constatarii lipsurilor (feronerie, piese) sau defectiunilor va rugam sa anuntati personalul LUX ARTIM in termen de 24 ore de la achizitionarea produsului, comunicand lipsurile si defectiunile constatate si numarul stampilei C.T.C. de pe ambalaj. In cazul necomunicarii defectiunilor sau lipsurilor constatate in termenul de mai sus, SC LUX-ARTIM SRL nu-si asuma raspunderea pentru eventualele neconformitati. Va multumim pentru intelegere.

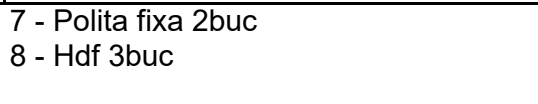
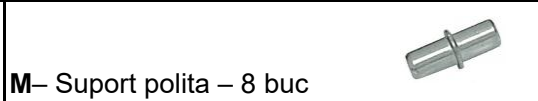
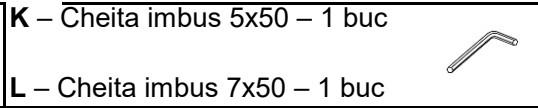
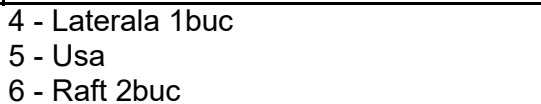
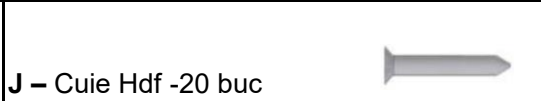
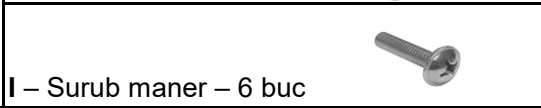
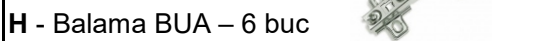
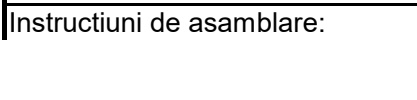
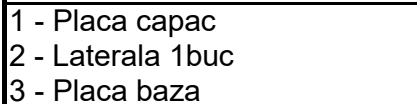
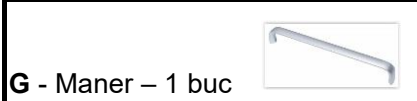
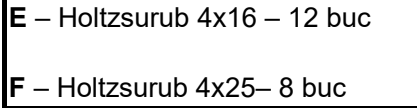
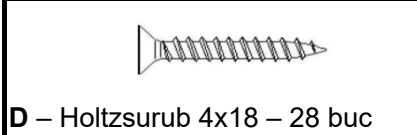
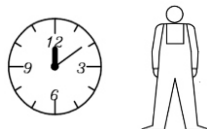
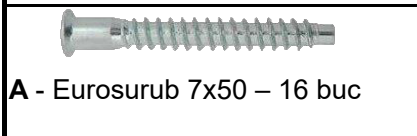
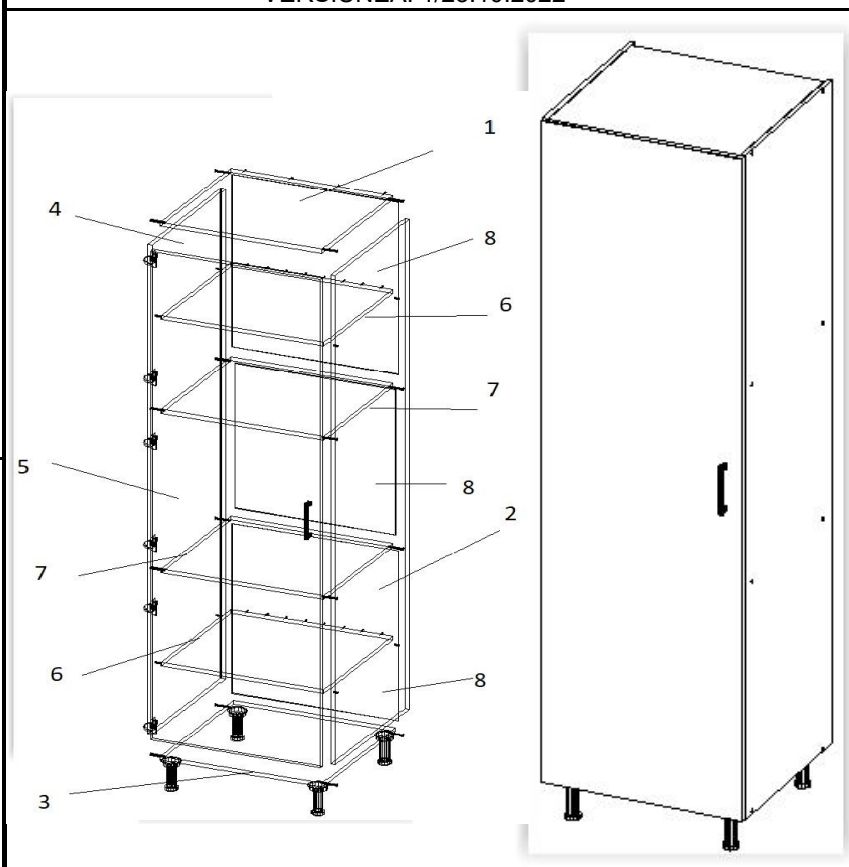

Instructiuni de asamblare:





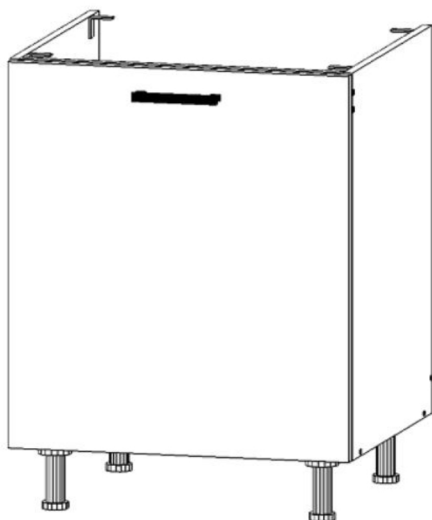



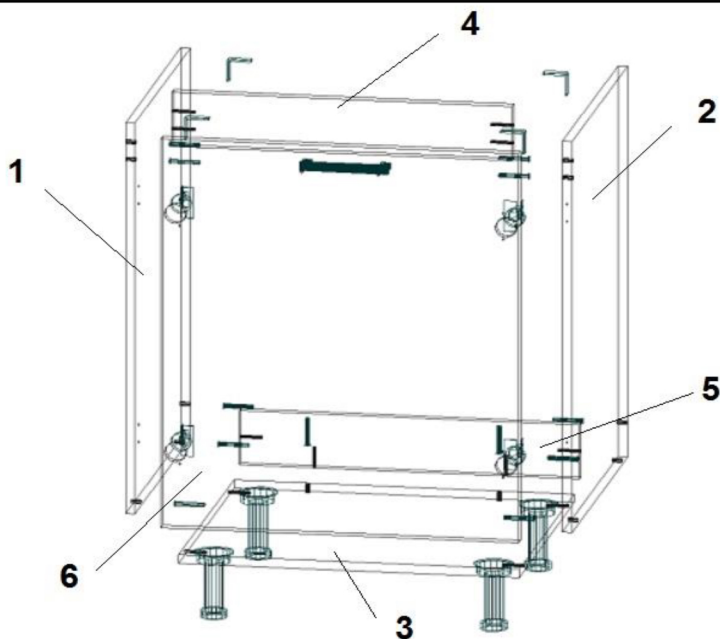

Va rugam sa verificati continutul coletului, existenta accesoriilor de feronerie, precum si a pieselor mentionate in schita de montaj. In cazul constatarii lipsurilor (feronerie, piese) sau defectiunilor va rugam sa anuntati personalul LUX ARTIM in termen de 24 ore de la achizitionarea produsului, comunicand lipsurile si defectiunile constatate si numarul stampilei C.T.C. de pe ambalaj. In cazul necomunicarii defectiunilor sau lipsurilor constatate in termenul de mai sus, SC LUX-ARTIM SRL nu-si asuma raspunderea pentru eventualele neconformitati. Va multumim pentru intelegere.

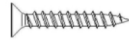
CHARM - C1S
MASCA CHIUVETA 1USA 60x84x54.3

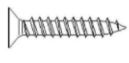
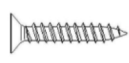

30min

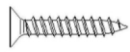

 A-eurosurub 7x50 - 12buc	 D-picior plastic 120 - 4buc	 G-holtzsurub 4x16 - 20buc	 J-capacele autoadezive-10buc
 B-maner banda - 1buc	 E-coltar Zn 40x40-4buc	 H-holtzsurub 4x25 - 4buc	 K-Holtzsurub 3.5x16 - 2buc
 C-balama - 2buc	 F-holtzsurub 4x18 - 20buc	 I-cheie imbus 7x50-1buc	

1-Laterala stanga-1buc	4-Lonjeron fata sus-1buc
2-Laterala dreapta-1buc	5-Lonjeron spate jos-1buc
3-Placa baza-1buc	6-Usa -1buc

1. Se cupleaza placa baza 3 de lateralele 1 si 2 cu eurosuruburi A;
 2. Se fixeaza lonjeroanele fata sus 4 si spate jos 5 de lateralele 1 si 2 cu eurosuruburi A;
 3. Se fixeaza picioarele D pe placa baza 3 cu holtzsuruburi F, la distanta de 4cm de marginea din fata respectiv spate, pe linia lateralelor, pentru a evita ruperea placii de baza;
 4. Se monteaza balamalele C pe usa 6 cu holtzsuruburi F;
 5. Se monteaza bratul balamalei F folosind holtzsuruburi G, pe laterala 1 sau 2 (dupa cum se doreste deschiderea usii), dupa care se strapung gaurile pentru maner cu un burghiu de 4,8 din interior spre exterior;
 6. Se fixeaza manerul B pe cantul usii 6, cu holtzsuruburi de maner K, pastrand 5cm de la margine;
 7. Se aplica capacele autoadezive J pe eurosuruburile A vizibile;
 8. Se fiseaza coltarele Zn E pe lateralele 1 si 2 cu holtzsuruburi G;
 9. Holtzsuruburile H pot fi folosite pentru cuplarea corpurilor intre ele;
- Dupa montare, recomandam aplicarea unui cordon de silicon intre laterale si placa baza.





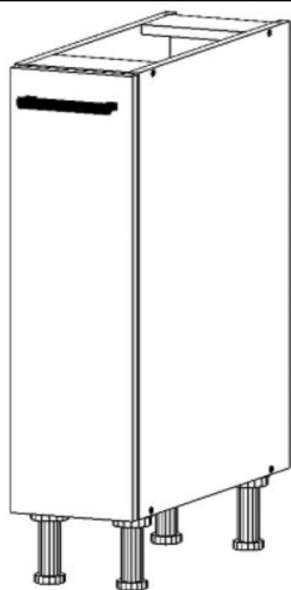



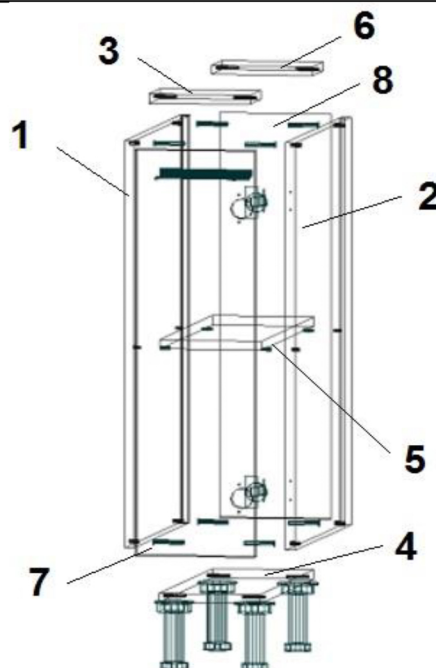



Va rugam sa verificati continutul coletului, existenta accesoriilor de feronerie, precum si a pieselor mentionate in schita de montaj. In cazul constatarii lipsurilor (feronerie, piese) sau defectiunilor va rugam sa anuntati personalul LUX ARTIM in termen de 24 ore de la achizitionarea produsului, comunicand lipsurile si defectiunile constatate si numarul stampilei C.T.C. de pe ambalaj. In cazul necomunicarii defectiunilor sau lipsurilor constatate in termenul de mai sus, SC LUX-ARTIM SRL nu-si asuma raspunderea pentru eventualele neconformitati. Va multumim pentru intelegere.

CHARM - C2D
CORP BAZA 1USA 1RAFT 20x84x54,3

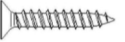

30min



 A-eurosurub 7x50 - 8buc	 D-holtzsurub 4x16 - 4buc	 G-maner - 1buc	 J-holtzsurub 4x25 - 4buc
 B-cuie HDF - 4buc	 E-picior plastic - 4buc	 H-balama - 2buc	 K-cheie imbus 7x50 - 1buc
 C-holtzsurub 4x18-20buc	 F- suport polita - 4buc	 I-surub maner - 2buc	 L-capacele autoadezive-8buc
1- Laterala stanga-1buc 2-Laterala dreapta-1buc 3-Lonjeron fata-1buc	4-Placa baza-1buc 5-Polita mobila-1buc 6-Lonjeron spate-1buc	7-Usa-1buc 8-Spate HDF-1buc	

1. Se cupleaza placa baza 4 de lateralele 1 si 2 cu eurosuruburi A;
2. Se aseaza placa spate HDF 8 in canalul de pe lateralele 1 si 2;
3. Se cupleaza lonjeroanele fata 3 si spate 6 de lateralele 1 si 2, folosind eurosuruburi A;
4. Se fixeaza placa spate HDF 8 de lonjeronul spate 6 si placa baza 4, folosind cuie HDF, B;
5. Pe placa baza 4, la 4cm de marginea din fata respectiv din spate, se prind picioarele E cu holtzsuruburi C, pe linia lateralelor pentru a evita ruperea placii de baza;
6. Se bat cu ciocanul suportii de polita F in gaurile de pe lateralele 1 si 2, dupa care se aseaza polita 5;
7. Se monteaza balamalele H pe usa 7 cu holtzsuruburi C
8. Se monteaza placutele balamalelor H, cu holtzsuruburi D, pe laterala 1 sau 2 (dupa cum doriti deschiderea), dupa care se gaureste pentru maner cu un burghiu de 4,8 din interior spre exterior;
9. Se fixeaza manerul G pe usa 7 cu suruburile I;
10. Se aplica capacelele autoadezive pe toate eurosuruburile A vizibile.

Va rugam sa verificati continutul coletului, existenta accesoriilor de feronerie, precum si a pieselor mentionate in schita de montaj. In cazul constatarii lipsurilor (feronerie, piese) sau defectiunilor va rugam sa anuntati personalul LUX ARTIM in termen de 24 ore de la achizitionarea produsului, comunicand lipsurile si defectiunile constatate si numarul stampilei C.T.C. de pe ambalaj. In cazul necomunicarii defectiunilor sau lipsurilor constatate in termenul de mai sus, SC LUX-ARTIM SRL nu-si asuma raspunderea pentru eventualele neconformitati. Va multumim pentru intelegere.

CHARM - C2S
CORP BAZA 1USA 1RAFT 60x84x54,3

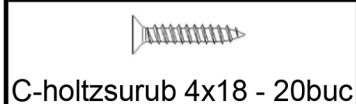
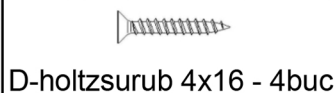
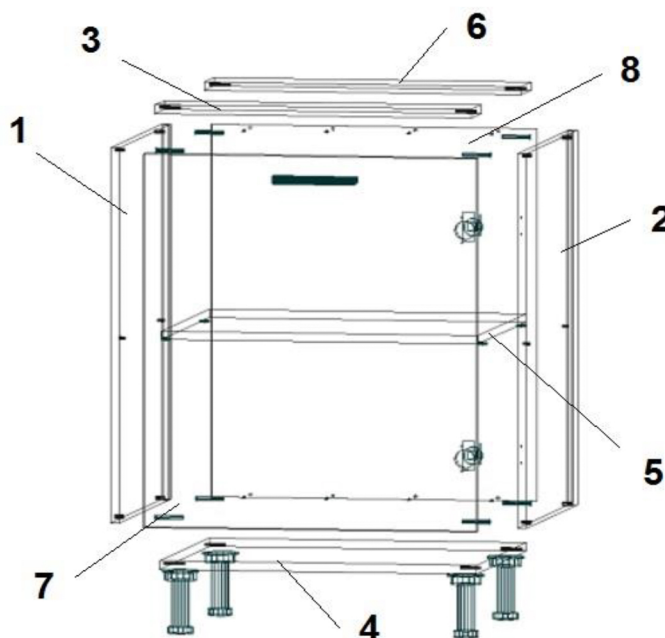
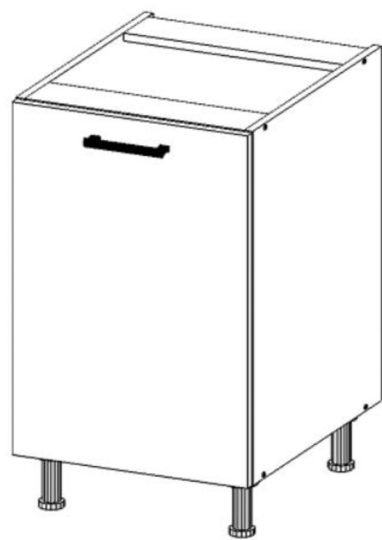

1- Laterala stanga-1buc

4-Placa baza-1buc

7-Usa-1buc

2-Laterala dreapta-1buc

5-Polita mobila-1buc

8-Placa spate HDF1buc

3-Lonjeron fata-1buc









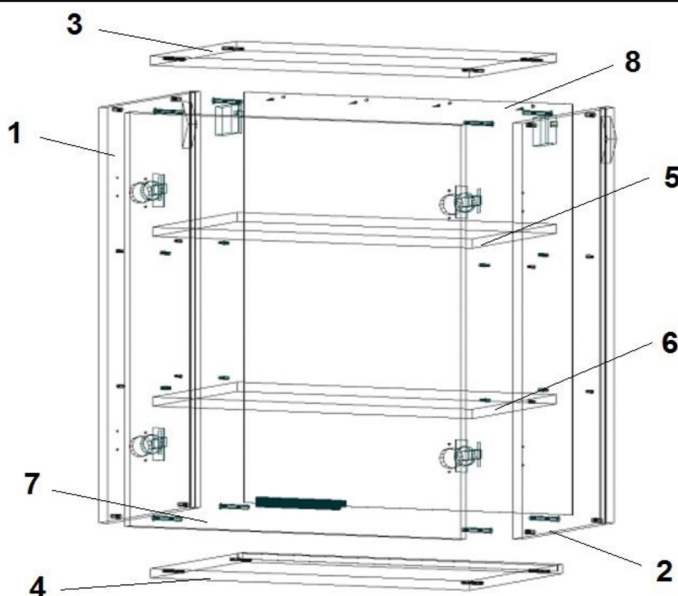
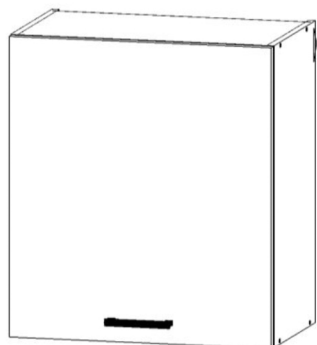

6-Lonjeron spate-1buc

1. Se cupleaza placa baza 4 de lateralele 1 si 2 cu eurosuruburi A;
2. Se aseaza placa spate HDF 8 in canalul de pe lateralele 1 si 2;
3. Se cupleaza lonjeroanele fata 3 si spate 6 de lateralele 1 si 2, folosind eurosuruburi A;
4. Se fixeaza placa spate HDF 8 de lonjeronul spate 6 si placa baza 7, folosind cuie HDF B;
5. Pe placa baza 4, la 4cm din fata respectiv din spate, se prind picioarele F cu holtzsuruburi C, pe linia lateralelor pentru a evita ruperea placii de baza;
6. Se bat cu ciocanul suportii de polita G in gaurile de pe lateralele 1 si 2, dupa care se aseaza polita 5;
7. Se monteaza balamalele I pe usa 7 cu holtzsuruburi C;
8. Se monteaza bratul balamalei H, cu holtzsuruburi D, pe laterala 1 sau 2 (dupa cum doriti deschiderea), dupa care se gaureste pentru maner cu un burghiu de 4,8 din interior spre exterior;
9. Se fixeaza manerul H pe usa 7 cu suruburile J;
10. Se aplica capacelele autoadezive pe toate eurosuruburile A vizibile;
11. Holtzsuruburile E pot fi folosite pentru cuplajul corpurilor intre ele.

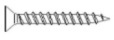
Va rugam sa verificati continutul coletului, existenta accesoriilor de feronerie, precum si a pieselor mentionate in schita de montaj. In cazul constatarii lipsurilor (feronerie, piese) sau defectiunilor va rugam sa anuntati personalul LUX ARTIM in termen de 24 ore de la achizitionarea produsului, comunicand lipsurile si defectiunile constatate si numarul stampilei C.T.C. de pe ambalaj. In cazul necomunicarii defectiunilor sau lipsurilor constatate in termenul de mai sus, SC LUX-ARTIM SRL nu-si asuma raspunderea pentru eventualele neconformitati. Va multumim pentru intelegere.

CHARM - C6S
CORP SUSPENDAT 1USA 2RAFTURI
60X72X37

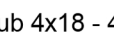

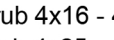
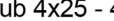
 A-eurosurub 7x50 - 8buc	 D-cuie HDF - 4buc	 I- suport polita - 8buc	 L-capacele autoadezive-8buc
 B-agnetator reglabil stanga-1buc	 E-holtzsurub 4x30 - 4buc	 J-cheie imbus 7x50- 1buc	 M-balama -2buc
 C-agnetator reglabil dreapta-1buc	 F-holtzsurub 4x18 - 4buc	 K-Surub maner - 2buc	 N-maner-1buc
 G-holtzsurub 4x16 - 4buc	 H-holtzsurub 4x25 - 4buc		

1- Laterală stanga-1buc
2-Laterală dreapta-1buc
3-Capac interior - 1buc

4-Placa baza-1buc
5-Polita mobila (raft)-1buc
6-Polita mobila (raft)-1buc

7-Usa -1buc
8- Spate HDF - 1buc

- Se cupleaza placa baza 4 de lateralele 1 si 2 cu eurosuruburi A;
- Se gaureste spatele HDF 8 astfel: se dau doua gauri cu freza $\Phi 25$, la 9mm de margine (stanga-dreapta) si 25mm de sus in jos;
- Se aseaza spatele HDF 8 in canalul lateralelor 1 si 2 si al placii baza 4, cu gaurile in partea de sus;
- Se cupleaza capacul interior 3 de lateralele 1 si 2 cu eurosuruburi A, dupa care se fixeaza de acesta placa spate HDF folosind cuie HDF D;
- Se fixeaza agatatorii reglabili B si C pe lateralele 1 si 2, in partea de sus a corpului, cu holtzsuruburi E;
- Se bat cu ciocanul suportii polita I in gaurile de pe lateralele 1 si 2, urmand a aseza politele 5 si 6;
- Se monteaza balamalele M pe usa 7 cu holtzsuruburi F;
- Se monteaza placutele balamalelor M cu holtzsuruburi G, pe laterala 1 sau 2(in functie de cum se doreste deschiderea usii) dupa care se strapung gaurile pentru maner cu un burghiu de 4,8 din interior spre exterior;
- Se fixeaza manerul N pe usa 7 cu suruburi K;
- Se aplica capacele L pe eurosuruburile A vizibile.
- Pentru cuplarea corpurilor intre ele se folosesc holtzsuruburile H.