

CORP SUPERIOR 1 USA

500 x 310 x 600 mm

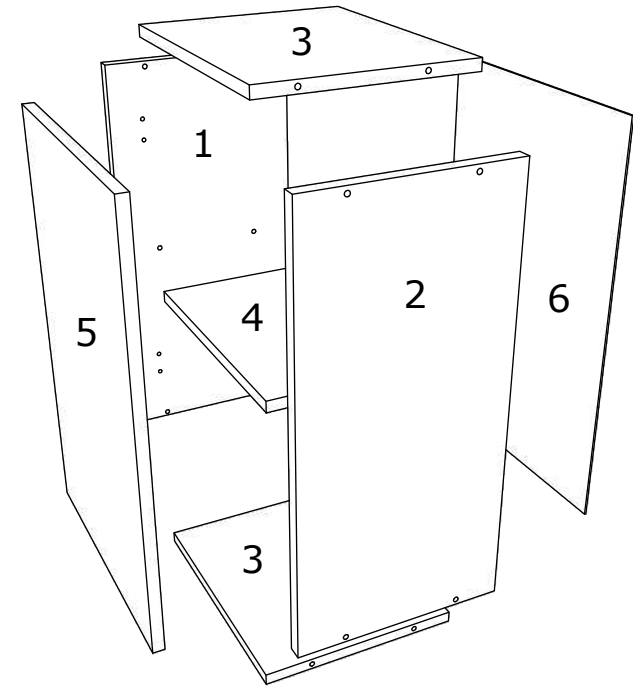
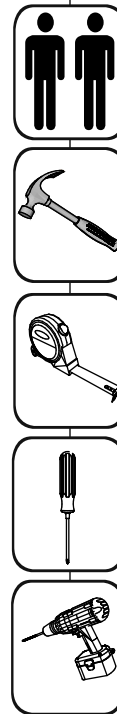
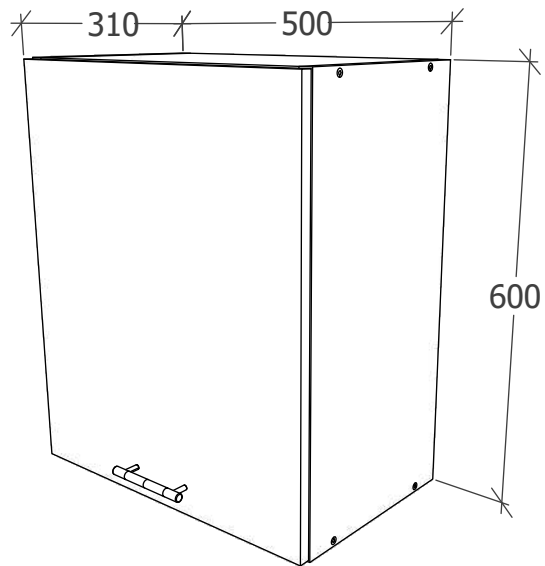

A	7x50mm	B		C	128 mm	D	M4 x 22 mm	E	3.5 x 16 mm	F	
	8 x		8 x		1 x		2 x		12 x		1 x
G		H		I		J	8 mm	K	6x80mm	L	
	2 x		4 x		26 x		2 x		2 x		2 x

No	B	b	x
1	600	290	1
2	600	290	1
3	468	290	2
4	468	268	1
5	596	496	1
6	596	496	1

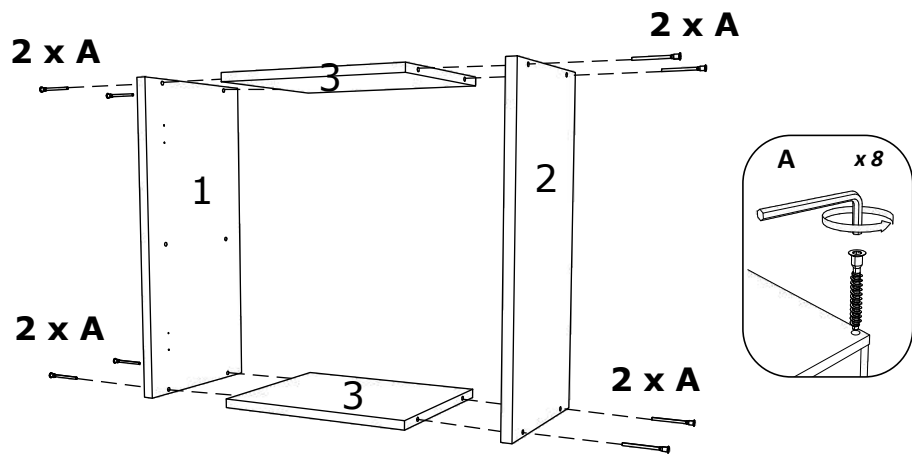

1

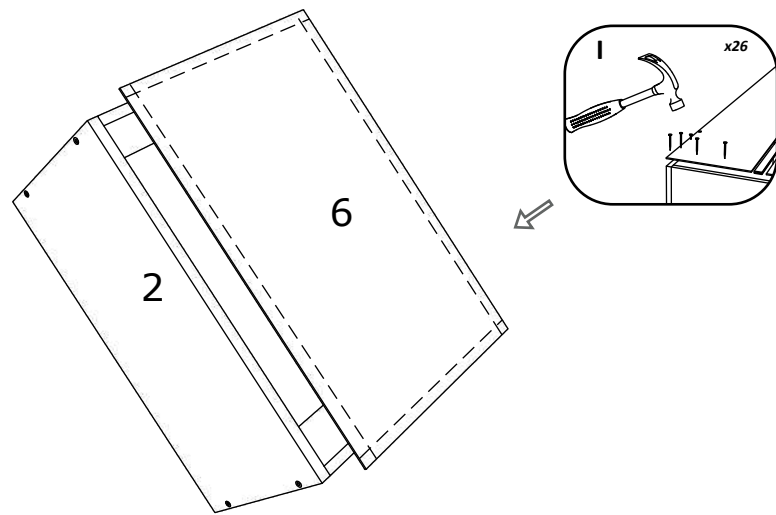

2

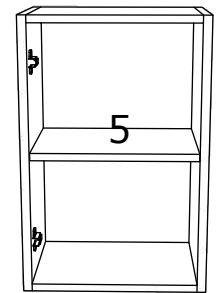
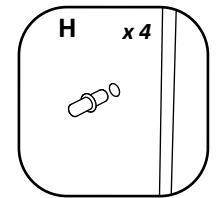
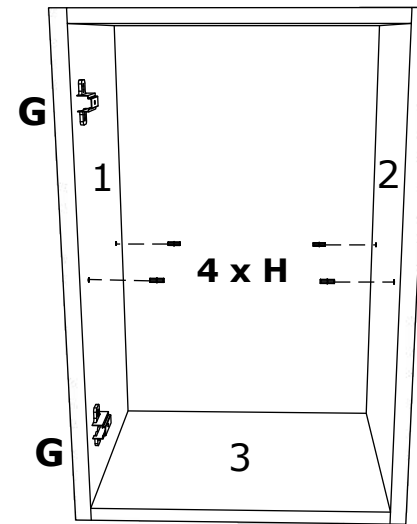

3

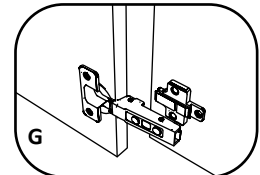
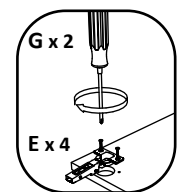
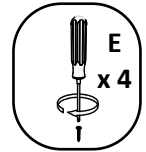
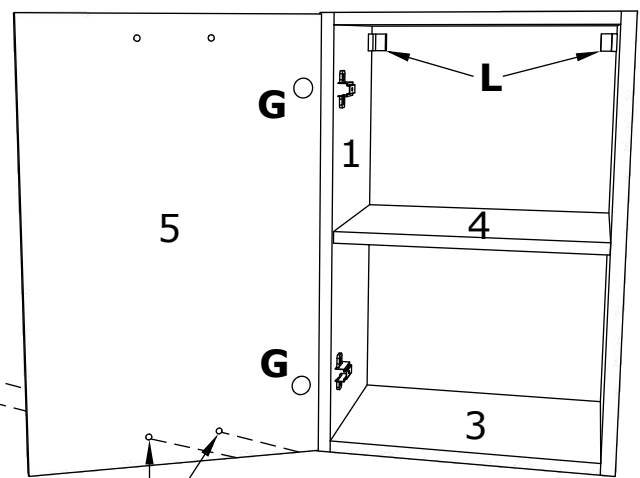
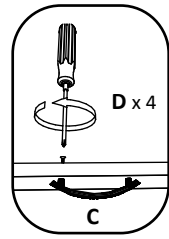
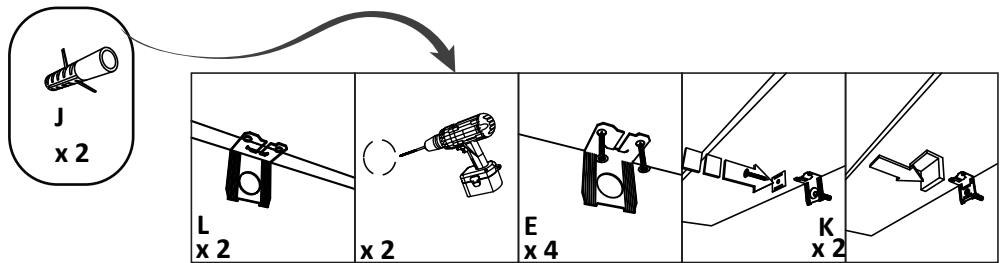

OR

