

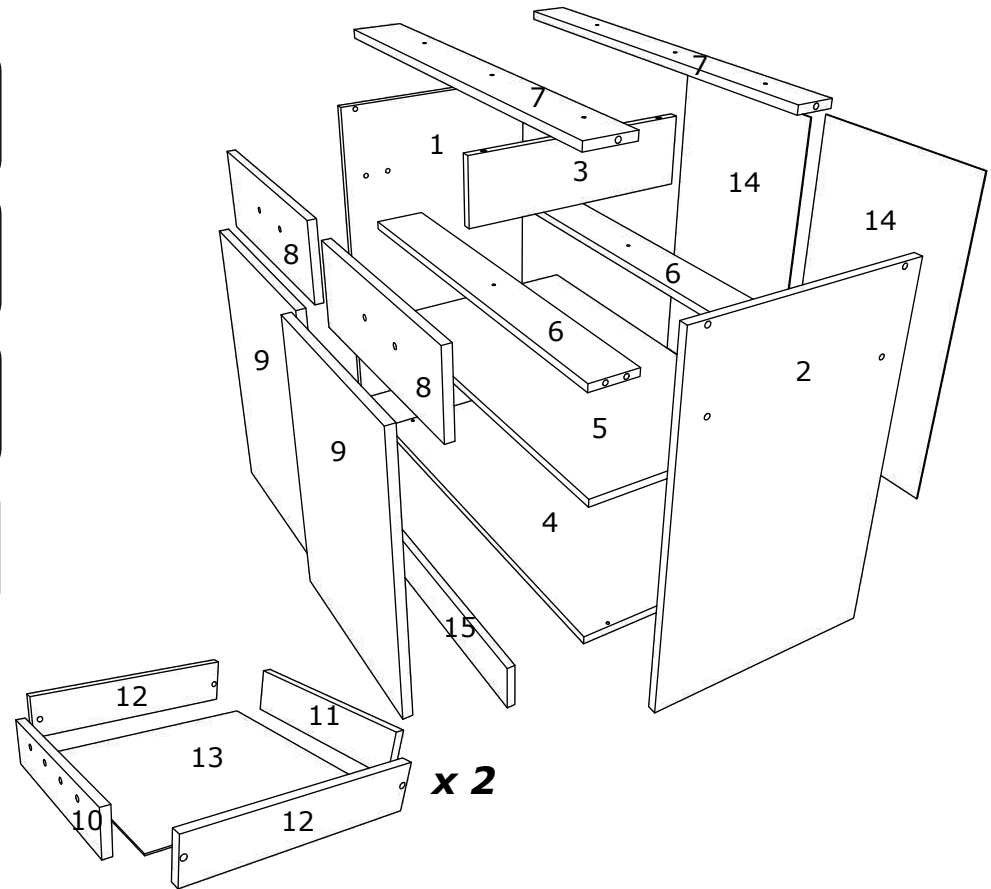

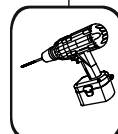

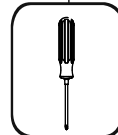

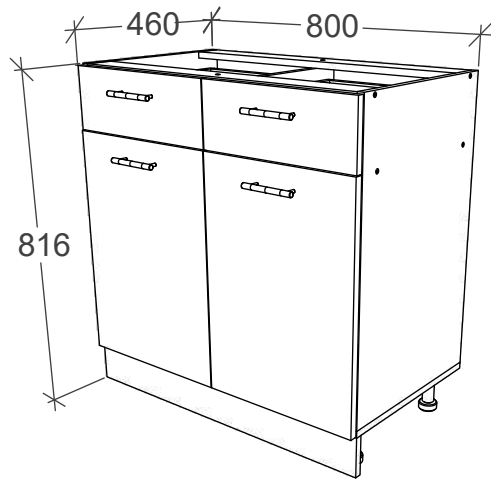

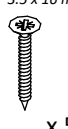

CORP BAZA 2 SERTARE + 2 USI

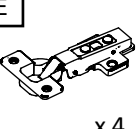
800 x 460 x 820 mm

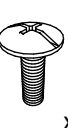
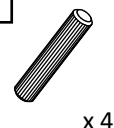
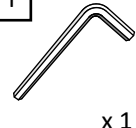
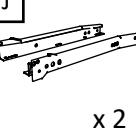
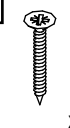

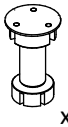
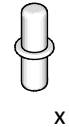
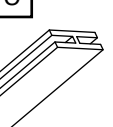
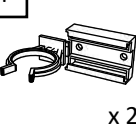
A	7x50mm  x 16	B	 x 8	C	3.5 x 16 mm  x 52	D	128 mm  x 4	E	 x 4	F	 x 60
G	M4 x 22 mm  x 8	H	 x 4	I	 x 1	J	400 mm  x 2	K	3.5 x 25 mm  x 8	L	3.5 x 35 mm  x 8
M	H100  x 4	N	 x 4	O	1 x 533mm 	P	 x 2	R	4.2 x 32 mm  x 4	S	∅ 12mm  x 4

No	B	b	x
1	700	440	1
2	700	440	1
3	132	440	1
4	800	440	1
5	768	420	1
6	768	100	2
7	768	70	2
8	396	152	2
9	396	556	2
10	319	80	2
11	319	80	2
12	400	80	4
13	400	350	2
14	712	396	2
15	800	95	1

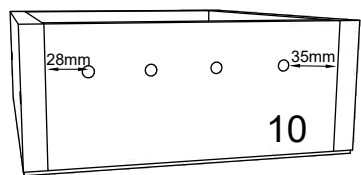
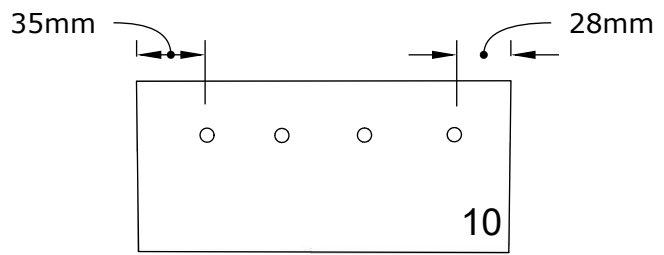
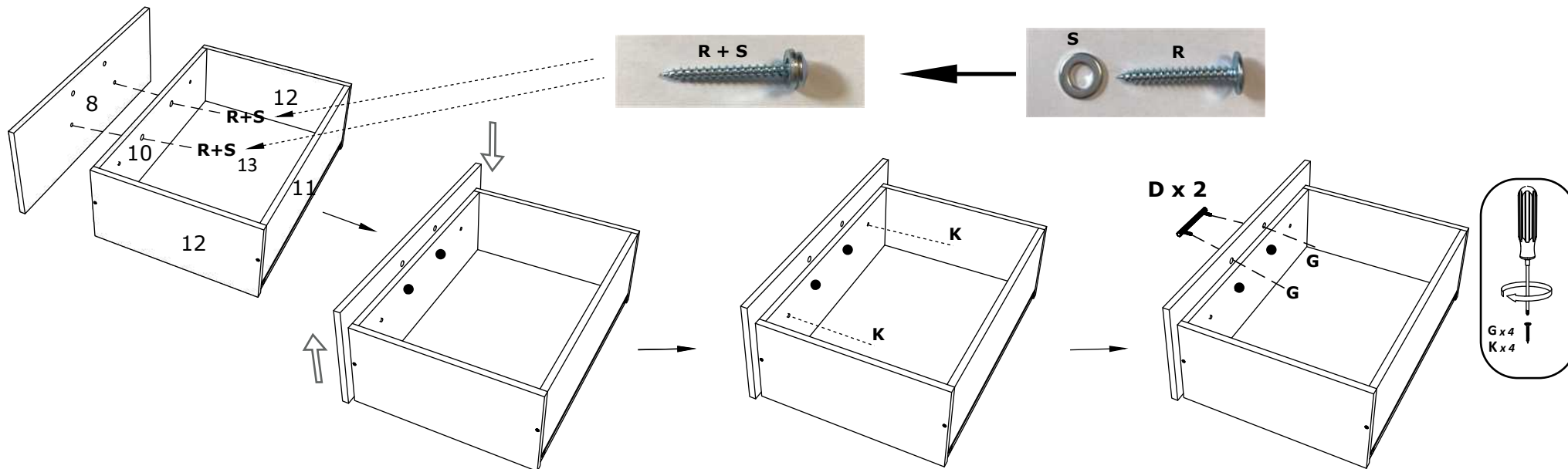

&

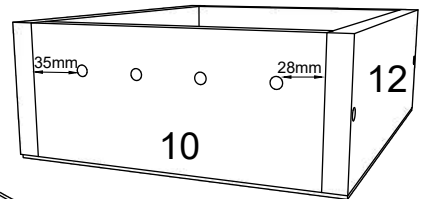

2 x

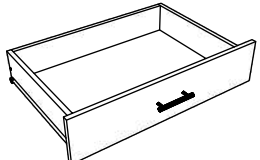

7

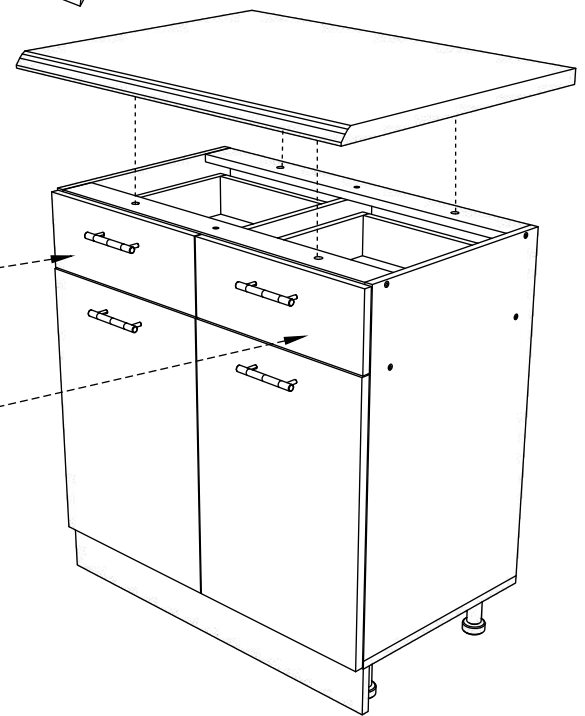

K x 4

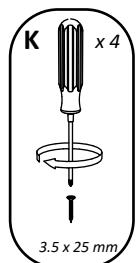

8