

# CORP SUPERIOR 2 USI

800 x 310 x 600 mm

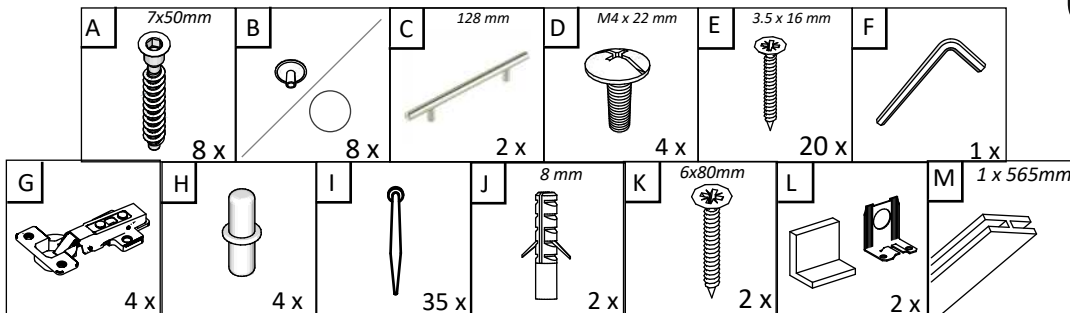

No	B	b	x
1	600	290	1
2	600	290	1
3	768	290	2
4	768	268	1
5	596	396	2
6	596	396	2

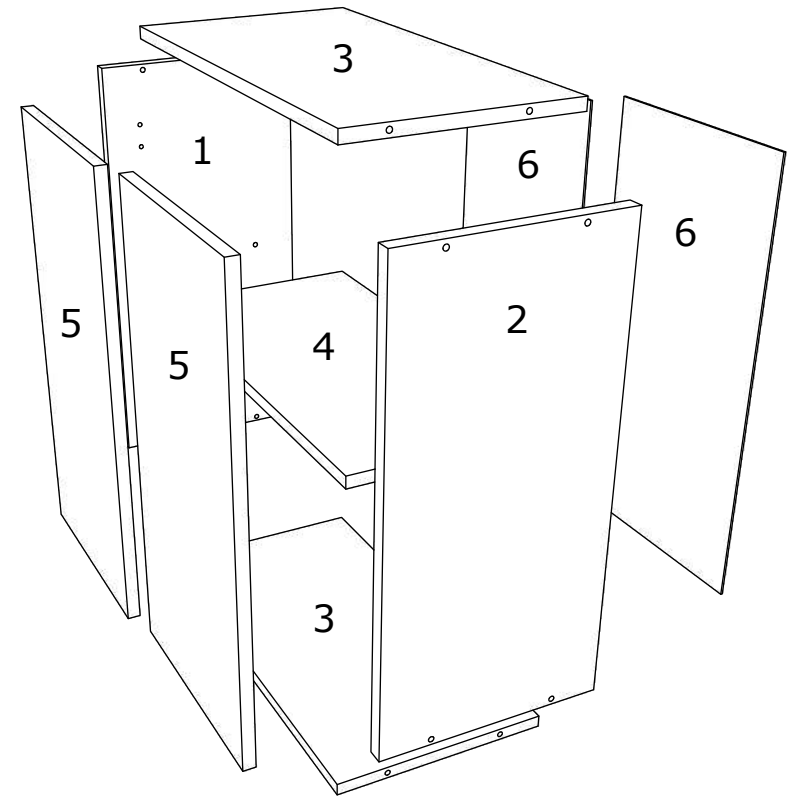
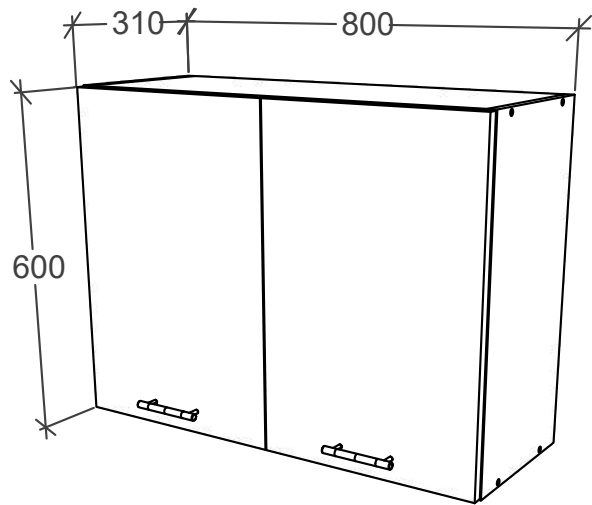
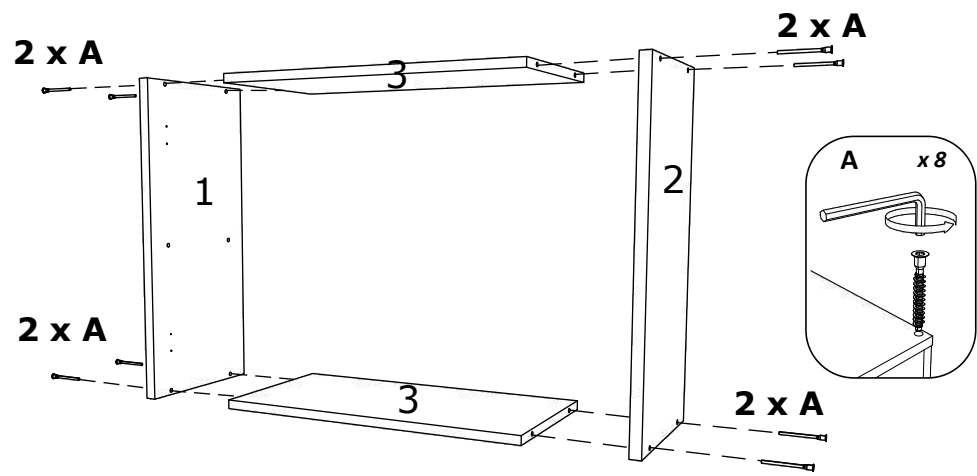

1

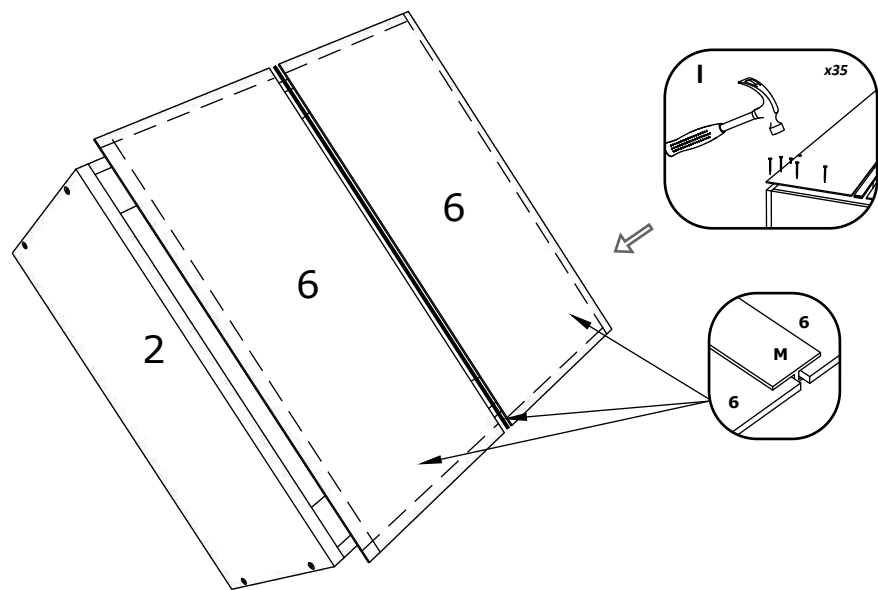

2

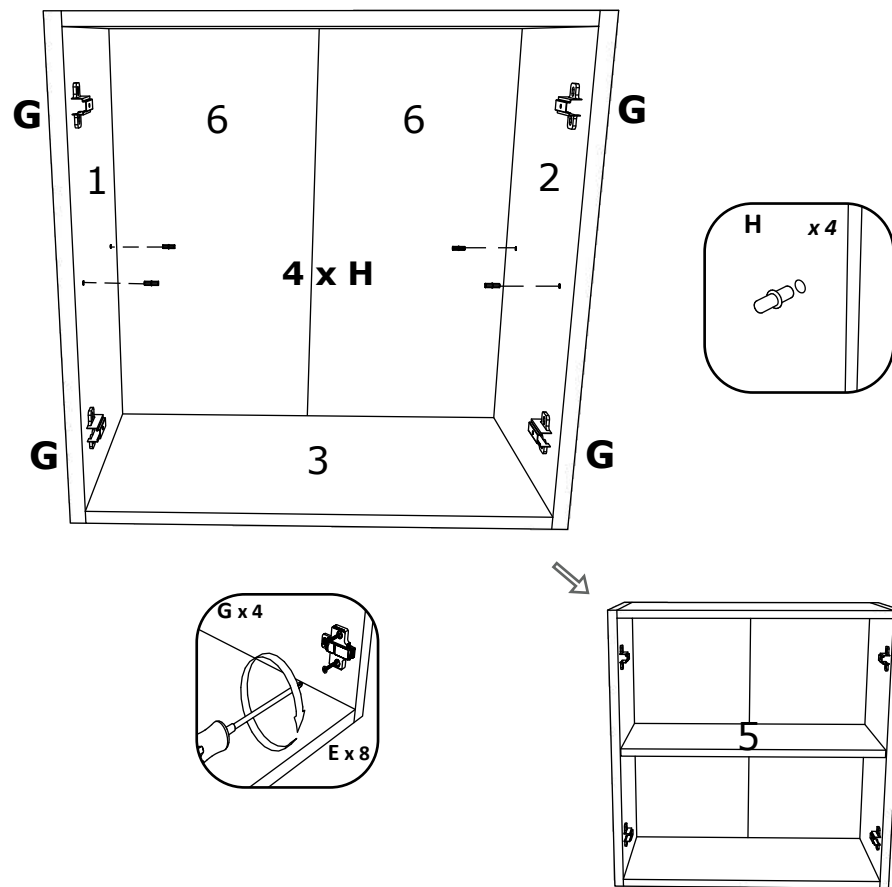

3

