

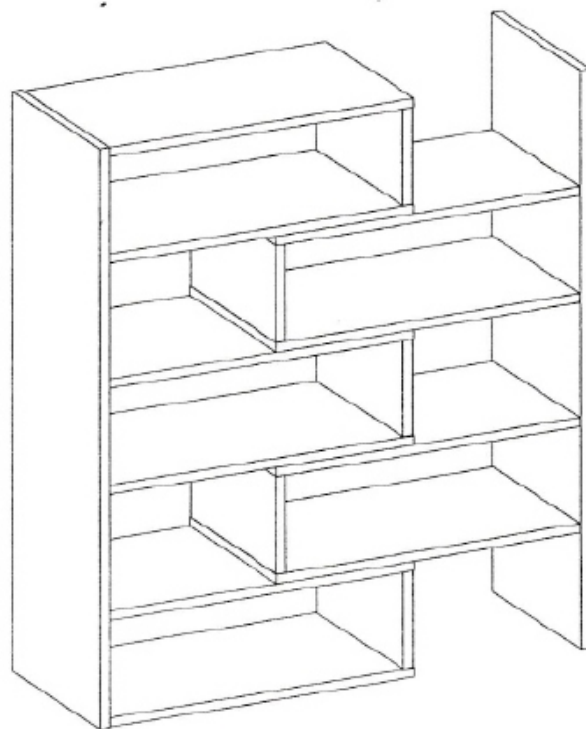

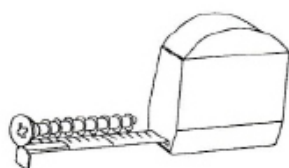

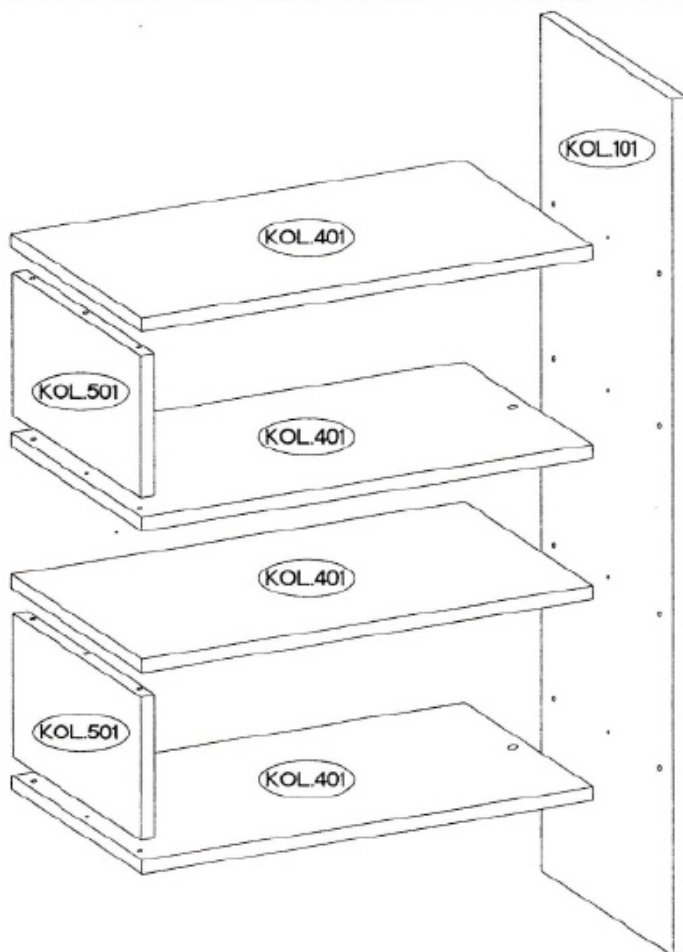

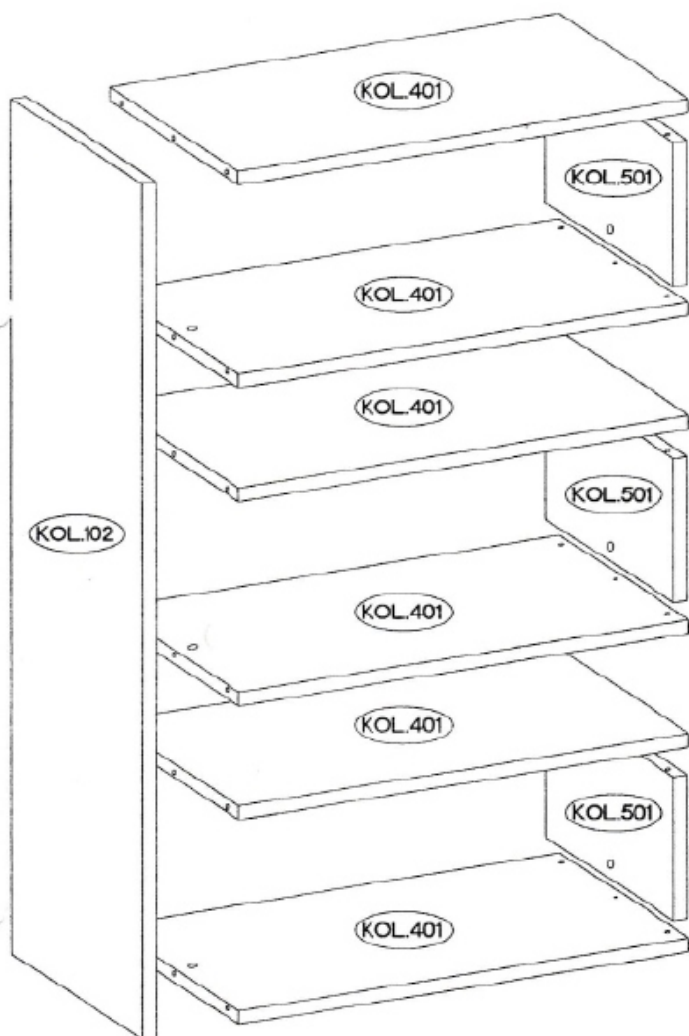

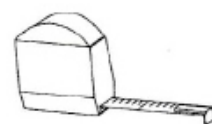
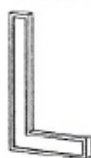
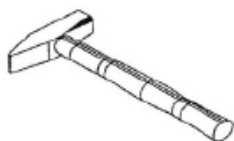

REGAL KLOE I a II



†8x30mm 	L=20mm 	†15/12mm 	†15x5mm 		0,05 
A	D2	C	F4	E	O11
40	20	20	6	20	1

1.

 #8x30mm A	 L=20mm D2	 #5/12mm C	 0,05 O11
40	20	20	1

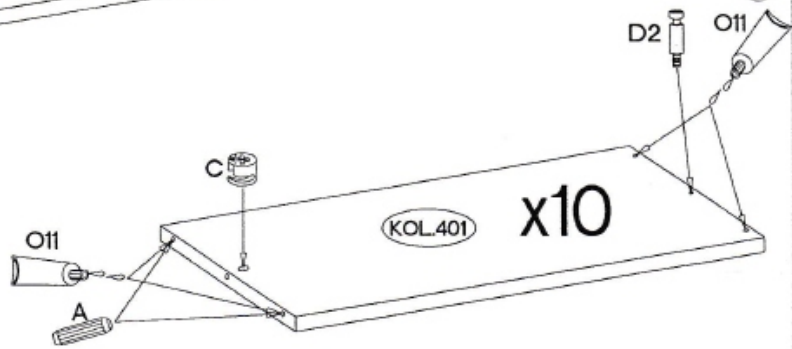
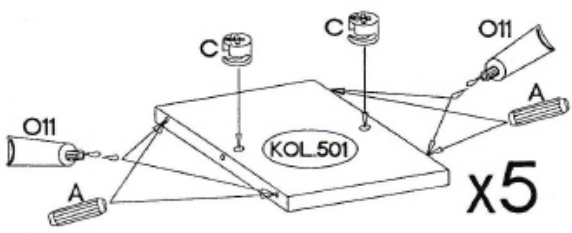
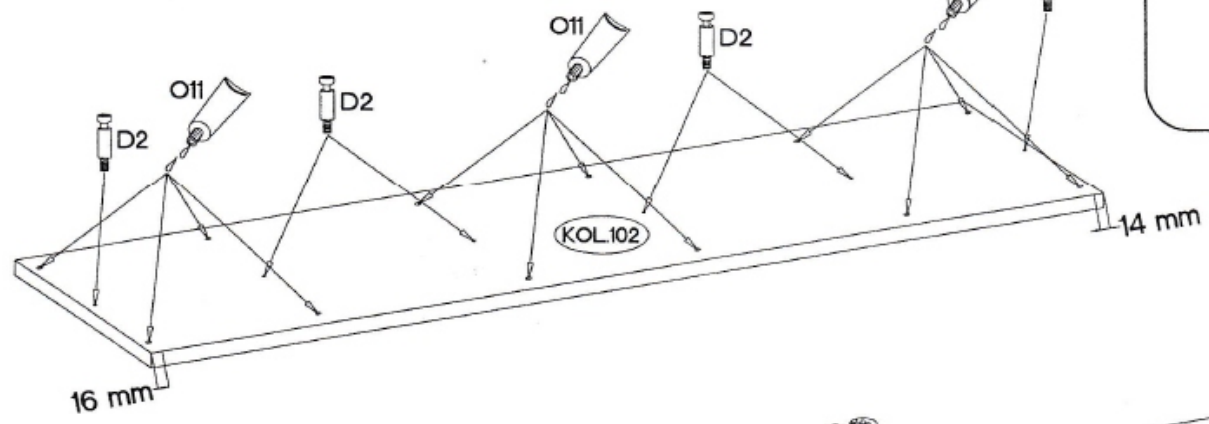
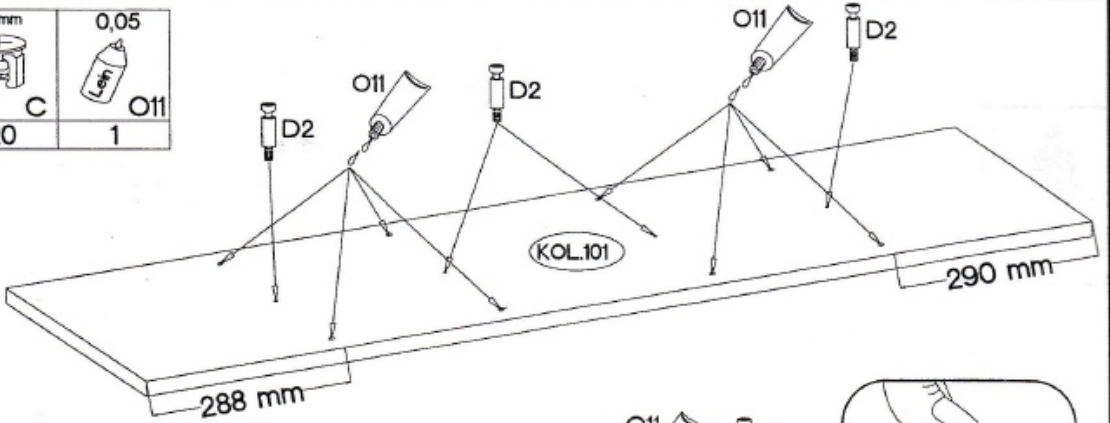
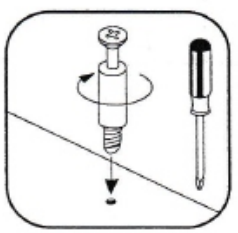

2.

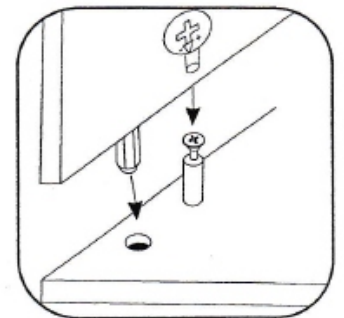
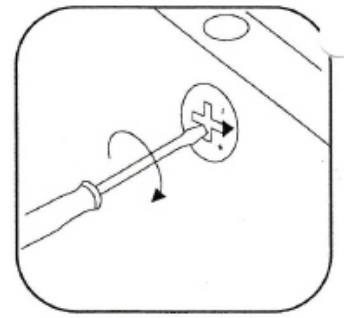
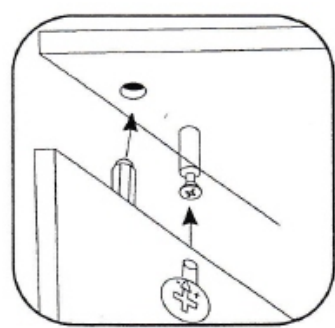
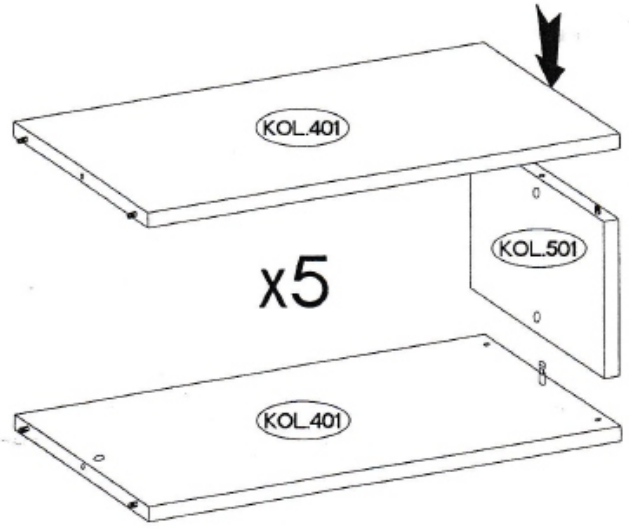

3.

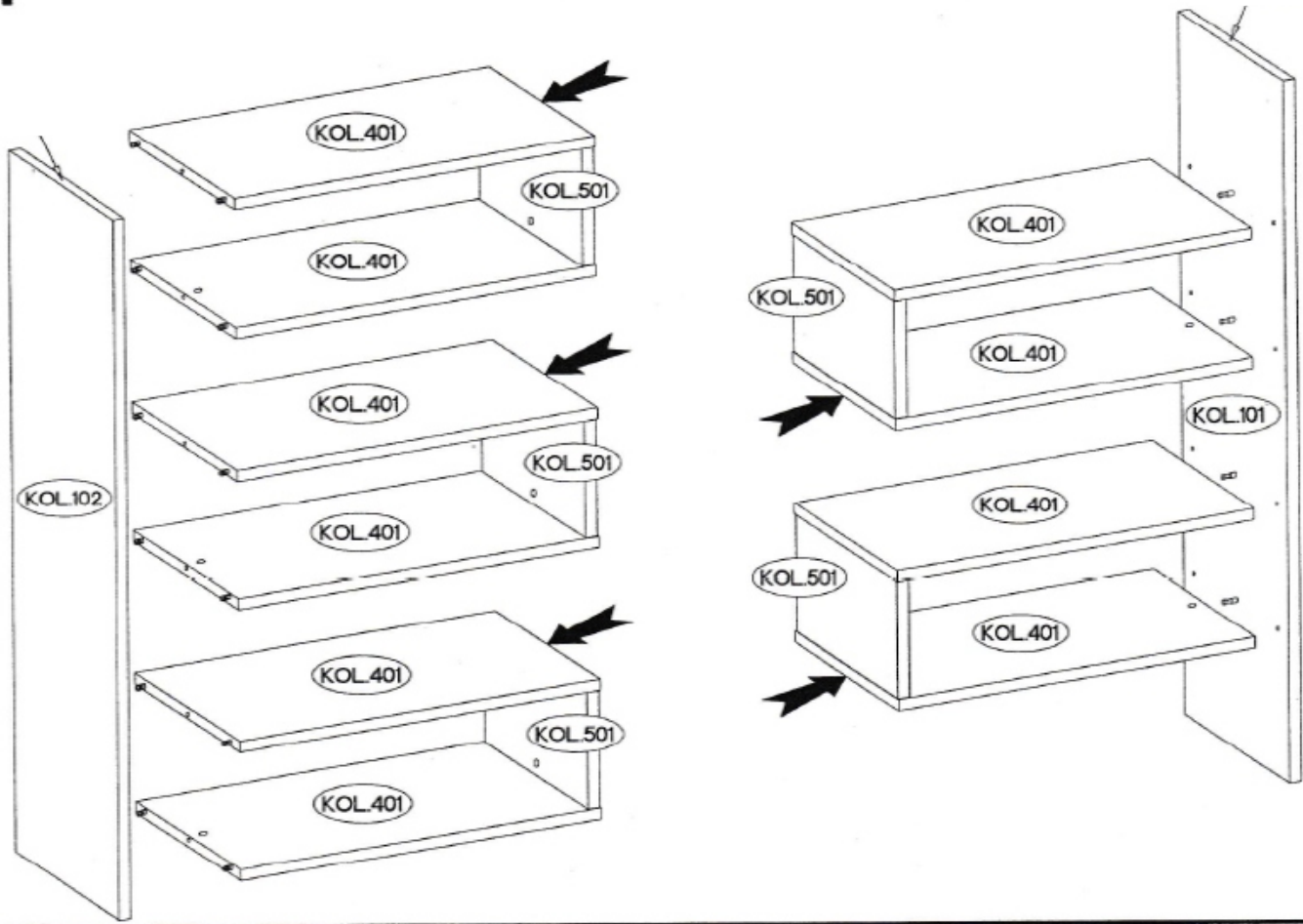

4.

±15x5mm		
	F4	E
	6	20

