



cabinete
medicale



unitati
de cazare



unitati
invatamant



cladiri
de birouri



spatii
comerciale

MARCA Gyptone®

Marca a grupului Saint-Gobain a carei gama de produse reunește plăci (Gyptone® Tiles) și panouri (Gyptone® BIG) din gips-carton (cu sau fără proprietăți acustice) utilizate la execuția tavanelor suspendate, demontabile sau nedemontabile. Plăcile pentru tavanele acustice sunt perforate, prevăzute la extradados cu un material cu proprietăți fonoabsorbante. Funcție de forma perforațiilor gama Gyptone dispune de modelele SIXTO, QUATTRO, POINT și LINE. Modelul fără perforații (fără proprietăți acustice) - BASE. Plăcile pentru coridoare - modelul PLANK.

DESCRIERE PRODUS _ Gyptone® Quattro 20

Plăci din gips-carton cu proprietăți acustice, perforații patrulate, vopsite în culoare albă (NCS 0500) utilizate în execuția tavanelor suspendate demontabile. Plăci cu muchie A (structura vizibilă), E (structura retrasă) sau D2 (structura ascunsă). Fața dinspre plenum este prevăzută cu o pană acustică de culoare albă. Produsele sunt incombustibile și se pot monta în medii cu o umiditate relativă maximă RH 70%. Toate produsele Gyptone beneficiază de tehnologia patentată Activ'Air, ce constă în reținerea și neutralizarea formaldehidei. Intra în componența sistemelor de tavane suspendate demontabile (casetate) cu structura vizibilă (plăci muchie A), retrasă / parțial vizibilă (plăci muchie E) sau ascunsă (plăci muchie D2). Plăcile au o mare durabilitate, păstrându-și de-a lungul timpului forma, planeitatea și culoarea. Sunt recomandate pentru amenajări de birouri, hoteluri, școli și grădinițe, spații comerciale și unități medicale.

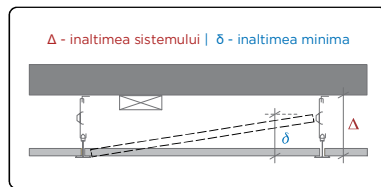
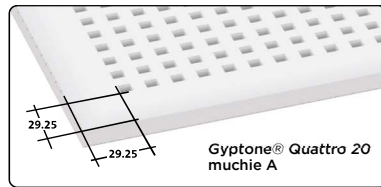
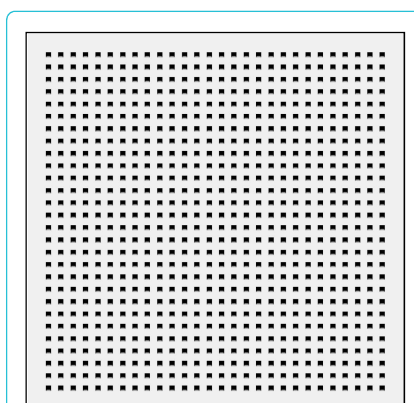
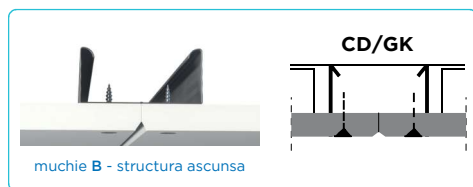
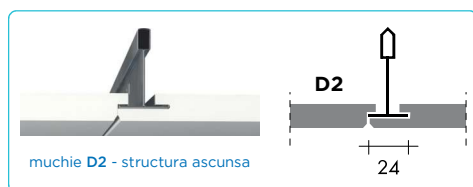
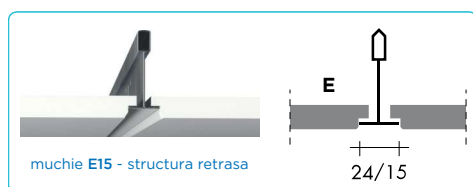
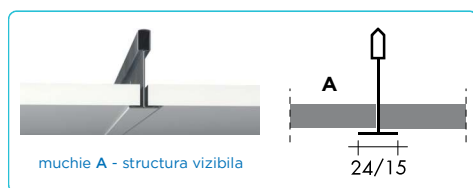

Gyptone Quattro 20

perforații patrulate 9 x 9 mm
distanța între perforații cca. 19.5 mm
aria perforată 18%
muchii placa A - E15 - E24 - D2 - B*

* Muchie B - plăci perforate, cu proprietăți acustice, nefinisate (nevopsite). Montaj pe structura metalică CD / GK

9 x 9
mm

Gyptone® Tiles Quattro 20

TAVANE SUSPENDATE
DEMONTABILE



Gyptone Activ'Air - descompunerea formaldehidei in componente inerte. Poate reduce concentratia de formaldehide cu pana la 70%, conform masuratorilor efectuate de laboratoarele Eurofins

INSTALARE. DATE TEHNICE.

Instalare rapida si usoara - placile muchie A si E se monteaza pe structura metalica Quick-Lock (T15-38 sau T24-32), structura de tip Hook-on. Placile muchie D2 se monteaza pe structura metalica Cross-Lock T24-38. Elementele de suspendare - sistem de suspendare rapid sau sistem Nonius. Inaltime minime de montaj (inaltime minima plenum): placi muchii A si E - 120 mm, placi muchie D2 - 195 mm, placi muchie B - 45 mm. Rigiditatea placilor si greutatea adecvata a acestora conduc la o excelenta planeitate a sistemului.

GYPTONE QUATTRO 20 - MODELE CARACTERISTICI TEHNICE					
model placa	Quattro 20 A	Quattro 20 E15	Quattro 20 E24	Quattro 20 D2	Quattro 20 B
dimensiuni modul (mm)	600x600	600x600	600x600	600x600	600x600
dimensiuni nominale (mm)	594 x 594	592 x 592	592 x 592	600x600	600x600
grosime placa (mm)	10	10	10	12,5	12,5
muchie placa	A	E15	E24	D2	B
perforatii	9 x 9	9 x 9	9 x 9	9 x 9	9 x 9
aria perforata	18%	18%	18%	18%	18%
finisaj / culoare	alb / NCS0500	alb / NCS0500	alb / NCS0500	alb / NCS0500	---
absorbție acustică α_w *	0,7	0,7	0,7	0,7	0,7
izolare acustica Dncw (db)	---	---	---	---	---
reactia la foc / Euroclass	A2-s1, d0	A2-s1, d0	A2-s1, d0	A2-s1, d0	A2-s1, d0
rezistenta la umiditate RH	70%	70%	70%	70%	70%
reflexia luminii	70%	70%	70%	70%	70%
incarcare maxima placa	3 kg	3 kg	3 kg	1 kg	---
greutate placa	7 kg/m2	7 kg/m2	7 kg/m2	8 kg/m2	8 kg/m2
montaj - tip structura	QL T24 / T15	QL T15-38	QL T24-32	QL T24-38	CD / GK



Perforatii placa
patrate 9 x 9 mm, la distanta de cca. 19.5 mm aria perforata 18%



Finisaj placa
placi vopsite in culoare alba, NCS 0500



Montaj placa
pe structura metalica Quick-Lock - muchii A si E Cross-Lock - muchie D2 CD/GK - muchie B



Inaltime minima plenum
muchie A si E - 120 mm muchie D2 - 195 mm muchie B - 45 mm



Intretinere placa
vopsire cu trafalet cu par scurt; nu se vopseste prin pulverizare



Curatare placa
cu ajutorul unei carpe umede; se pot folosi agenti standard de curatare

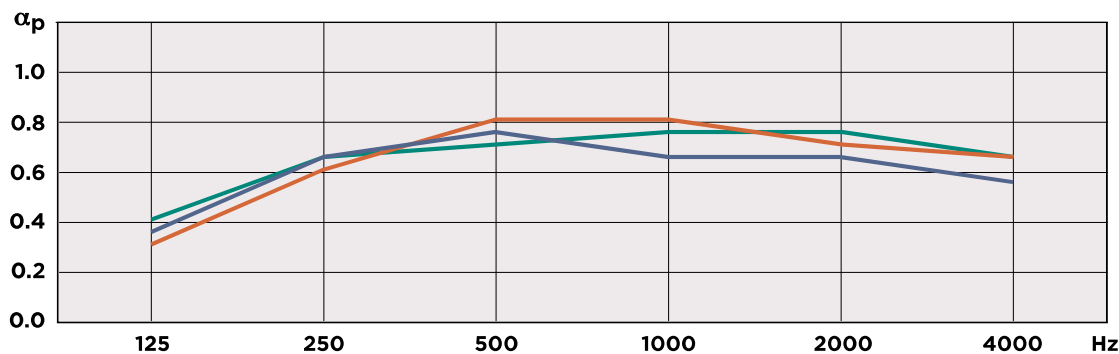

Plenum	saltea vata	Frecventa						α_w	NRC	Clasa Absorbție
		125 Hz	250 Hz	500 Hz	1 kHz	2 kHz	4 kHz			
58 mm	45 mm	0.35	0.65	0.85	0.85	0.75	0.70	0.80	0.80	B
200 mm	-	0.40	0.70	0.80	0.70	0.70	0.60	0.70	0.70	C
300 mm	70 mm	0.45	0.70	0.75	0.80	0.80	0.70	0.80	0.75	B

ABSORBTIA ACUSTICA (α_p | α_w)

Masuratorile acustice sunt conforme cu cerintele ISO 354. Absorbția acustică este influentata de inaltimea plenumului, aria perforata a placii si de existenta in plenum a unui strat izolator - vata minerala de sticla sau bazaltica)

Gyptone® Tiles Quattro 20

TAVANE SUSPENDATE
DEMONTABILE



Gyptone Activ'Air - descompunerea formaldehidei in componente inerte. Poate reduce concentratia de formaldehide cu pana la 70%, conform masuratorilor efectuate de laboratoarele Eurofins

SISTEME TAVAN SUSPENDAT DEMONTABIL

placi muchie A sau E
modul standard 600 x 600 mm

Sistem Quick-Lock
T24-32 / T15-38

placi muchie A
modul standard 600 x 1200 mm

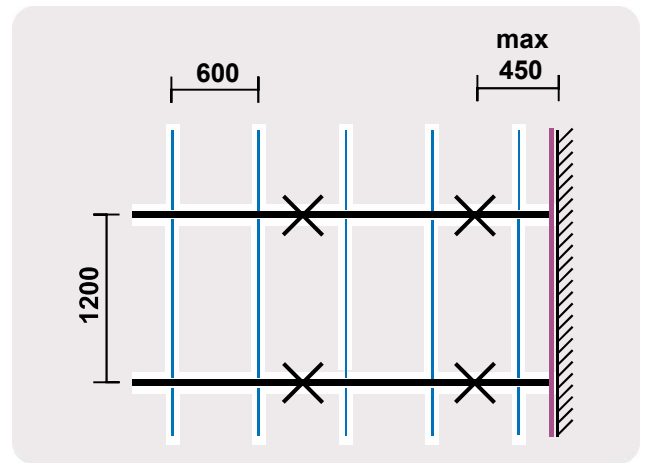
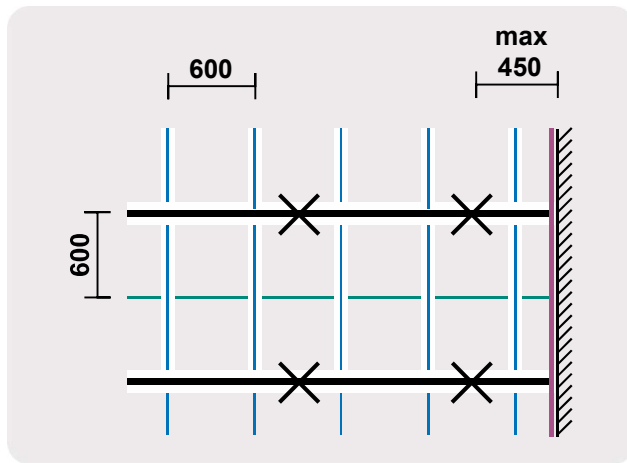

— Profil principal
QL 24-32 / QL 15-38
L3600 mm

— Profil secundar
QL 24-32 / QL 15-38
L1200 mm

— Profil compartimentare
QL 24-32 / QL 15-38
L600 mm

× Piese de suspendare
Sistem rapid
Sistem Nonius

— Profil perimetral
sectiune L sau W
L3000 mm

Sistem Cross-Lock T24-38 | structura ascunsa, placi 600 x 600 mm, muchie D2

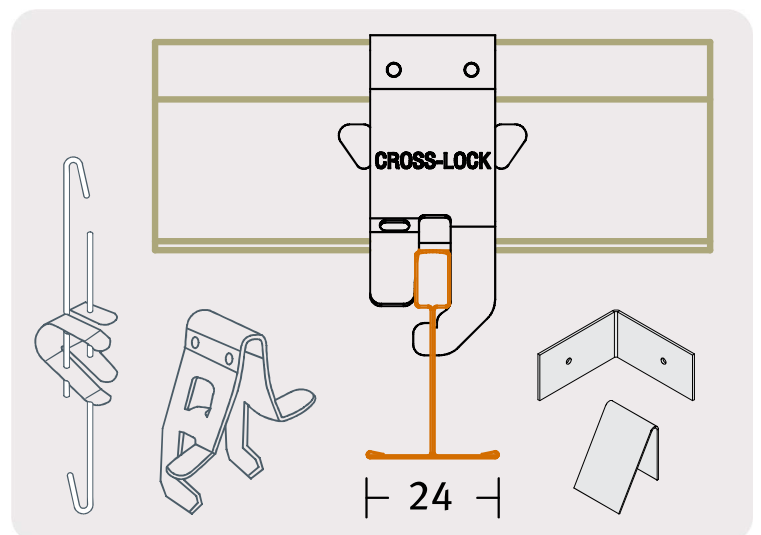
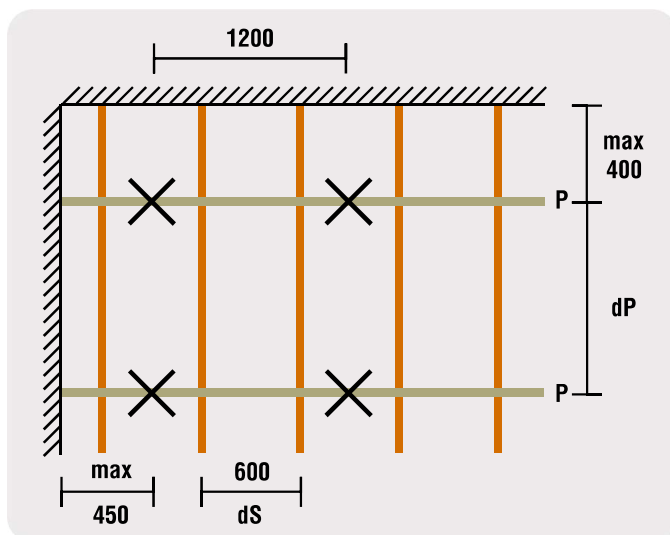

— Grinda principala
QL 24/38

— Grinda secundara
QL 24/38

× Piese de suspendare
Sistem rapid sau
Sistem Nonius

Gyptone® Tiles Quattro 20

TAVANE SUSPENDATE
DEMONTABILE

ACTIV
air

Gyptone Activ'Air - descompunerea formaldehidei in componente inerte. Poate reduce concentratia de formaldehide cu pana la 70%, conform masuratorilor efectuate de laboratoarele Eurofins

MODELE DE PLACA. TIPURI CONSTRUCTIVE STRUCTURA.



placa muchie A

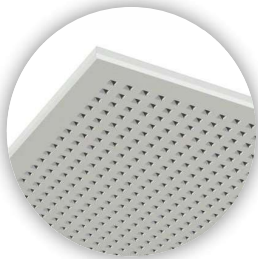

placa muchie B



placa muchie E



placa muchie D2

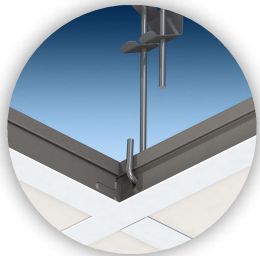

Quick-Lock
structura vizibila

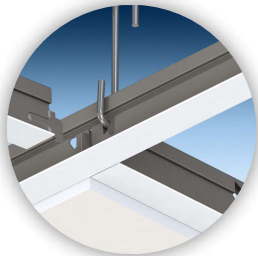

Quick-Lock
structura retrasa

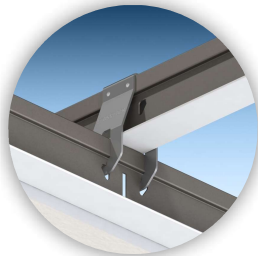

Cross-Lock
structura ascunsa

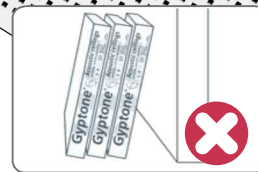
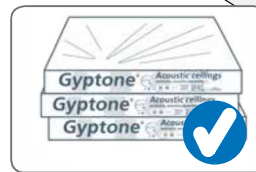

manipulare si depozitare cutii placi Gyptone

SAINT-GOBAIN

SAINT-GOBAIN ROMANIA • RIGIPS

Calea Floreasca nr. 165
One United Tower • etaj 10
Sector 1 • 014459 Bucuresti • Romania

Tel: +40 21 207 57 50/51
info.constructionproducts@saint-gobain.com
www.rigips.ro



Produsele acustice Gyptone sunt testate de Danish Indoor Climate labeling, conform cu normele French Health and Environmental Authority's labelling. Produsele uzate, sunt reciclabile 100% si pot intra in productia de noi produse din gips.



Informatii vizand nivelul emisiilor de substante volatile in aerul interior, care reprezinta un risc de toxicitate prin inhalare, pe o scara de la A+ (emisii foarte scazute la C (emisii puternice))

Links

Gyptone Tiles
DoP GYP 14190-1-v2
Structura Quick-Lock
Structura Cross-Lock
www.rigips.ro