

Fișa tehnică

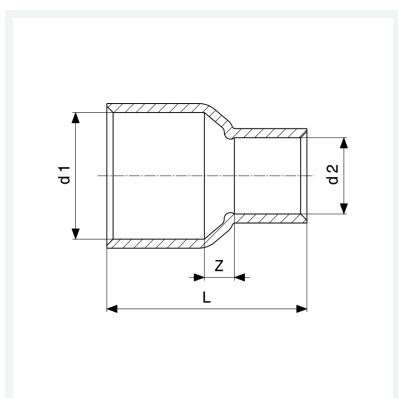

Mufă redusă
- îmbinare prin lipire
model 95240

articol 116 118



Caracteristici

Asigurarea calității Cu	Cu	✓
Diametrul exterior al țevii 1	d1	54
Diametrul exterior al țevii 2	d2	42
Dimensiune Z	Z	11 mm
Lungime	L	70 mm
Greutate	163,6 g	
Volum	414,4 cm ³	
Material	cupru	