

Fișa tehnică

viega



Mufă redusă
- îmbinare prin lipire
model 95240

articol 117 269

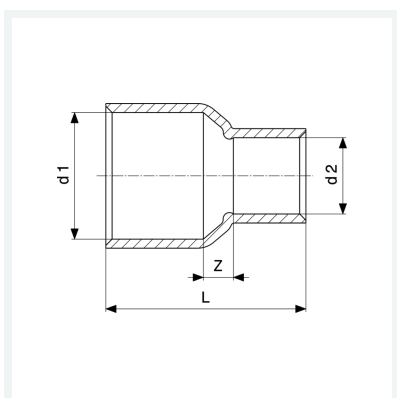

Caracteristici

Asigurarea calității Cu	Cu	✓
Diametrul exterior al țevii 1	d1	42
Diametrul exterior al țevii 2	d2	28
Dimensiune Z	Z	13 mm
Lungime	L	59 mm
Greutate	91,8 g	
Volum	177,6 cm ³	
Material	cupru	