

Fișa tehnică

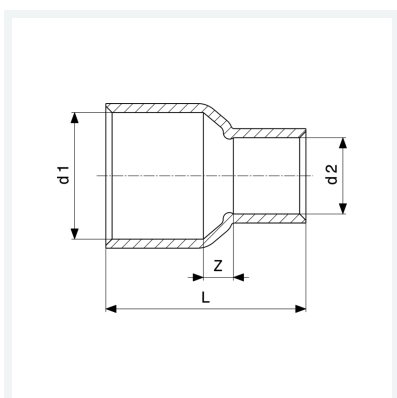

Mufă redusă
- îmbinare prin lipire
model 95240

articol 102 111



Caracteristici

Asigurarea calității Cu	Cu	✓
Diametrul exterior al țevii 1	d1	28
Diametrul exterior al țevii 2	d2	22
Dimensiune Z	Z	5 mm
Lungime	L	43 mm
Greutate	40,12 g	
Volum	62,16 cm ³	
Material	cupru	