

Fișa tehnică

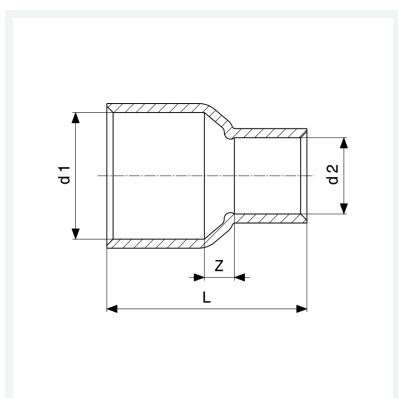

Mufă redusă
- îmbinare prin lipire
model 95240

articol 106 256



Caracteristici

Asigurarea calității Cu	Cu	✓
Diametrul exterior al țevii 1	d1	28
Diametrul exterior al țevii 2	d2	18
Dimensiune Z	Z	7 mm
Lungime	L	42 mm
Greutate	39,1 g	
Volum	62,16 cm ³	
Material	cupru	