

Fișa tehnică

viega



Mufă redusă
- îmbinare prin lipire
model 95240

articol 101 602

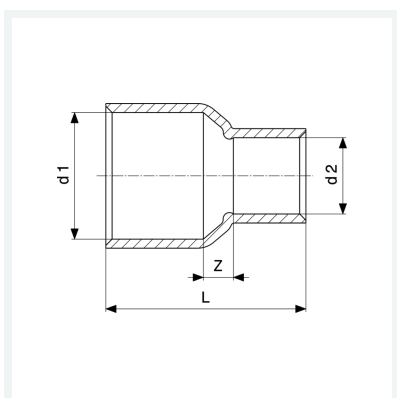

Caracteristici

Asigurarea calității Cu	Cu	✓
Diametrul exterior al țevii 1	d1	22
Diametrul exterior al țevii 2	d2	18
Dimensiune Z	Z	6 mm
Lungime	L	35 mm
Greutate	21,5 g	
Volum	41,44 cm ³	
Material	cupru	