

Fișa tehnică

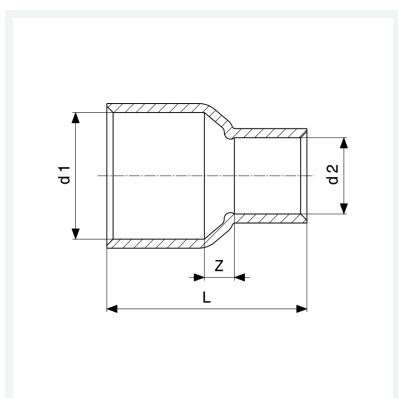

Mufă redusă
- îmbinare prin lipire
model 95240

articol 101 565



Caracteristici

Asigurarea calității Cu	Cu	✓
Diametrul exterior al țevii 1	d1	22
Diametrul exterior al țevii 2	d2	15
Dimensiune Z	Z	7 mm
Lungime	L	37 mm
Greutate	22,3 g	
Volum	35,52 cm ³	
Material	cupru	