

Fișa tehnică

viega



Reducție
- inserție, îmbinare prin lipire
model 95243

articol 103 118

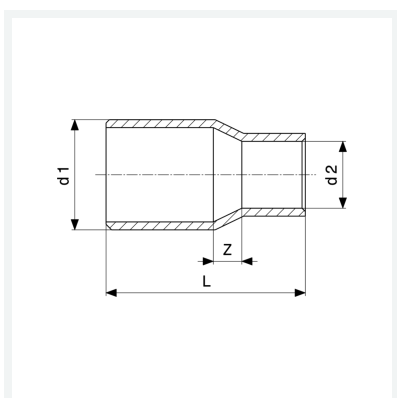

Caracteristici

Asigurarea calității Cu	Cu	✓
Diametrul exterior al țevii 1	d1	35a
Diametrul exterior al țevii 2	d2	28
Dimensiune Z	Z	5 mm
Lungime	L	49 mm
Greutate	60,8 g	
Volum	124,32 cm ³	
Material	cupru	