

Fișa tehnică

viega



Reducție
- inserție, îmbinare prin lipire
model 95243

articol 105 792

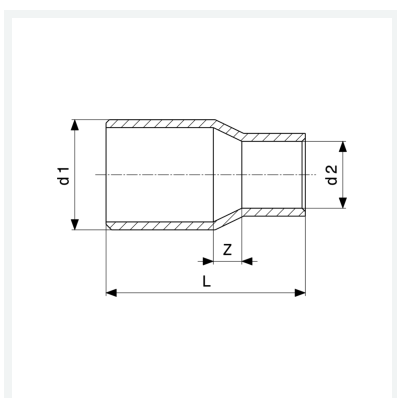

Caracteristici

Asigurarea calității Cu	Cu	✓
Diametrul exterior al țevii 1	d1	35a
Diametrul exterior al țevii 2	d2	22
Dimensiune Z	Z	7 mm
Lungime	L	48 mm
Greutate	60,4 g	
Volum	95,631 cm ³	
Material	cupru	