

Fișa tehnică

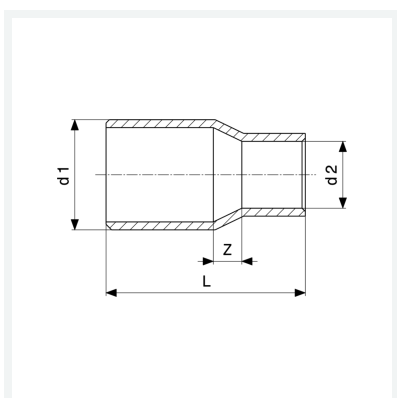

Reducție
- inserție, îmbinare prin lipire
model 95243

articol 101 015



Caracteristici

Asigurarea calității Cu	Cu	✓
Diametrul exterior al țevii 1	d1	28a
Diametrul exterior al țevii 2	d2	22
Dimensiune Z	Z	6 mm
Lungime	L	42 mm
Greutate	34,6 g	
Volum	124,32 cm ³	
Material	cupru	