

Fișa tehnică

viega



Reducție
- inserție, îmbinare prin lipire
model 95243

articol 100 780

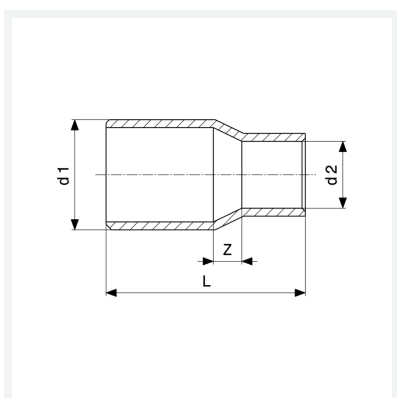

Caracteristici

Asigurarea calității Cu	Cu	✓
Diametrul exterior al țevii 1	d1	22a
Diametrul exterior al țevii 2	d2	18
Dimensiune Z	Z	4 mm
Lungime	L	35 mm
Greutate	22,3 g	
Volum	35,52 cm ³	
Material	cupru	