

Fișa tehnică

viega



Curbă 90°
- îmbinare prin lipire, inserție
model 95001A

articol 100 391

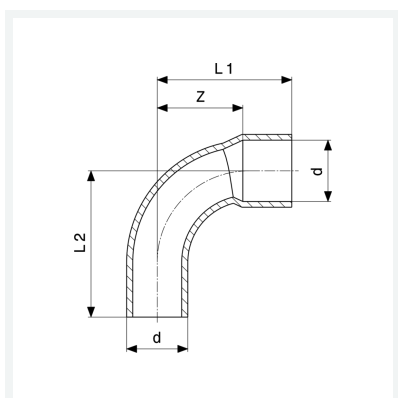

Caracteristici

Asigurarea calității Cu	Cu	✓
Diametrul exterior al țevii	d	22
Dimensiune Z	Z	26 mm
Lungime 1	L1	42 mm
Lungime 2	L2	43 mm
Greutate	48,8 g	
Volum	69,3 cm ³	
Material	cupru	