

Fișa tehnică

viega



Curbă 90°
- îmbinare prin lipire, inserție
model 95001A

articol 100 155

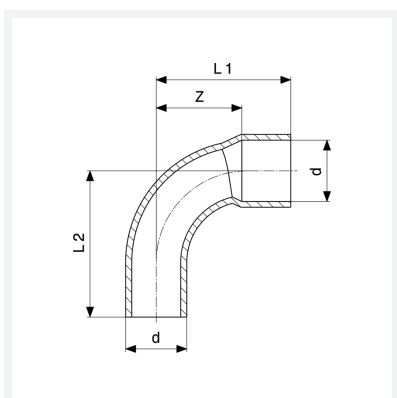

Caracteristici

Asigurarea calității Cu	Cu	✓
Diametrul exterior al țevii	d	15
Dimensiune Z	Z	18 mm
Lungime 1	L1	29 mm
Lungime 2	L2	31 mm
Greutate	19 g	
Volum	49,728 cm ³	
Material	cupru	