

# Fișa tehnică

**viega**



**Curbă 45°**  
- îmbinare prin lipire, inserție  
**model 95040**

**articol 100 773**

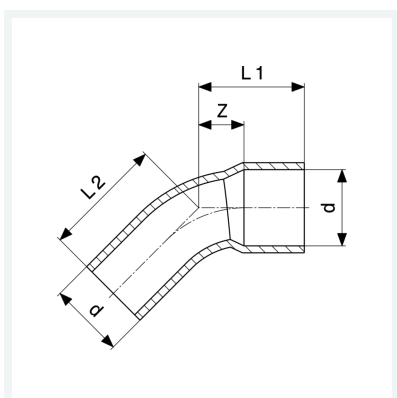

## Caracteristici

Asigurarea calității Cu	Cu	✓
Diametrul exterior al țevii	d	18
Dimensiune Z	Z	8 mm
Lungime 1	L1	21 mm
Lungime 2	L2	22 mm
Greutate	19,5 g	
Volum	49,728 cm <sup>3</sup>	
Material	cupru	