

Fișa tehnică

viega



Curbă 45°
- îmbinare prin lipire, inserție
model 95040

articol 100 292

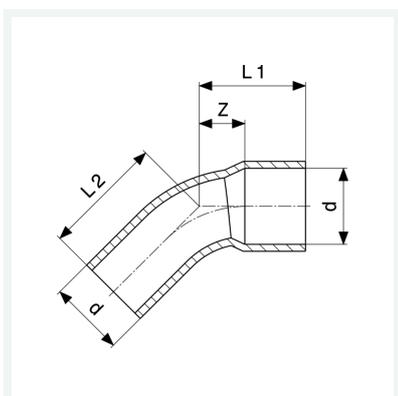

Caracteristici

Asigurarea calității Cu	Cu	✓
Diametrul exterior al țevii	d	15
Dimensiune Z	Z	6 mm
Lungime 1	L1	17 mm
Lungime 2	L2	19 mm
Greutate	11,7 g	
Volum	24,01 cm ³	
Material	cupru	