

Fișa tehnică

viega



Cot la 90°
- îmbinare prin lipire, inserție
model 95092

articol 102 067

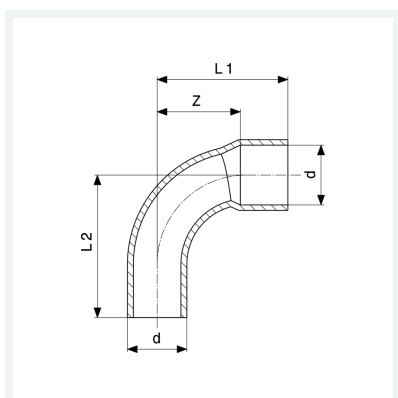

Caracteristici

Diametrul exterior al țevii	d	28
Dimensiune Z	Z	25 mm
Lungime 1	L1	44 mm
Lungime 2	L2	47 mm
Greutate	82,8 g	
Volum	124,3 cm ³	
Material	cupru	