

Fișa tehnică

viega



Cot la 90°
- îmbinare prin lipire, inserție
model 95092

articol 101 169

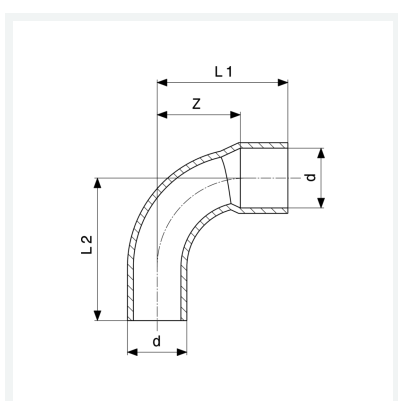

Caracteristici

Diametrul exterior al țevii	d	18
Dimensiune Z	Z	14 mm
Lungime 1	L1	27 mm
Lungime 2	L2	30 mm
Greutate	23,9 g	
Volum	49,728 cm ³	
Material	cupru	