

Fișa tehnică

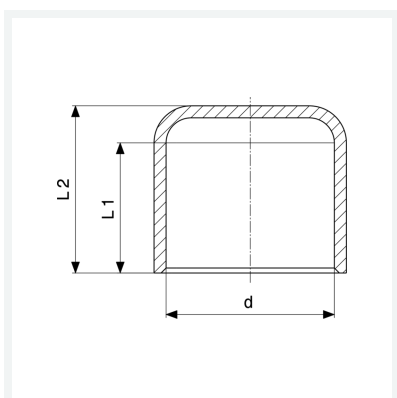

Capac
- îmbinare prin lipire
model 95301

articol 102 951



Caracteristici

Diametrul exterior al țevii	d	22
Lungime 1	L1	15 mm
Lungime 2	L2	18 mm
Greutate	16 g	
Volum	24,864 cm ³	
Material	cupru	