

Fișă tehnică Canal, tip WDK 80210

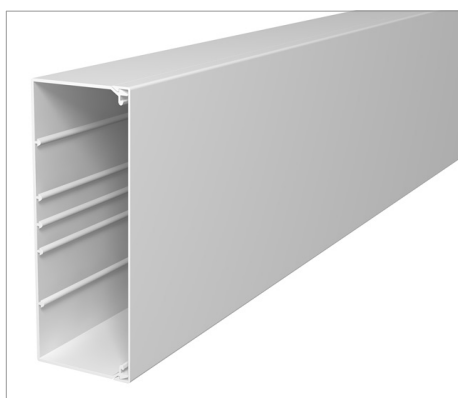

Capac și canal cu bază perforată.

Tip	Culoare	Lungime mm	Amb. m	Greutate kg/100 m	Nr. art.
WDK80210RW	alb pur; RAL 9010	2000	8	240.000	6191312
WDK80210CW	alb crem; RAL 9001	2000	8	240.000	6026206
WDK80210LGR	gri deschis; RAL 7035	2000	8	240.000	6027237
WDK80210GR	gri piatră; RAL 7030	2000	8	240.000	6026192

PVC Policlorură de vinil

l €/m

